



OM-284794A

2019-11

Processes



TIG (GTAW) Welding



Stick (SMAW) Welding

Description



208-240/480V Arc Welding Power Source

Syncrowave[®] 300

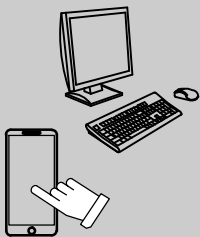
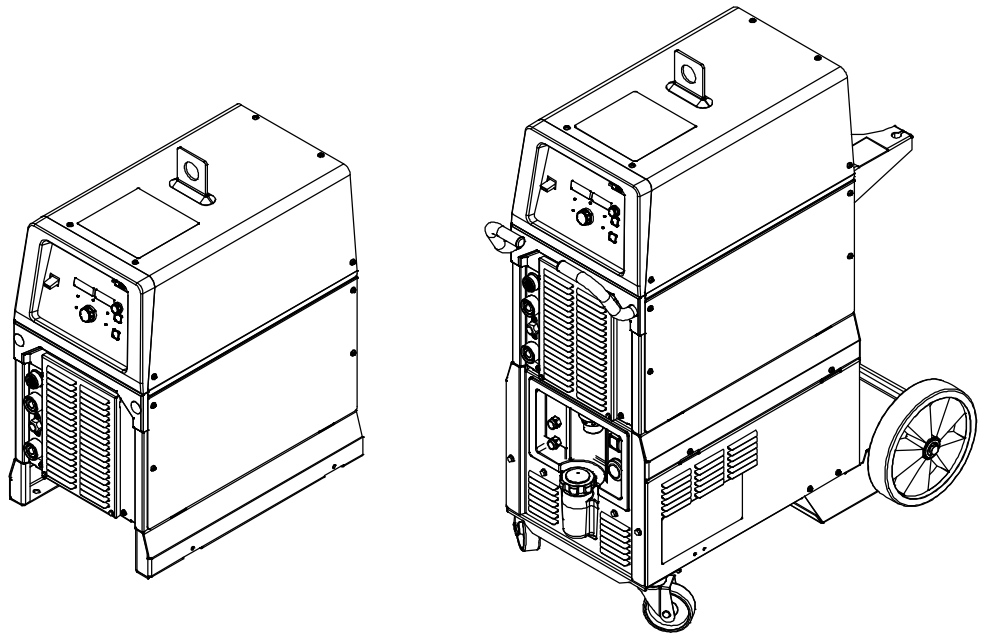

For product information,
Owner's Manual translations,
and more, visit

www.MillerWelds.com

OWNER'S MANUAL

File: TIG (GTAW)



From Miller to You

Thank you and congratulations on choosing Miller. Now you can get the job done and get it done right. We know you don't have time to do it any other way.

That's why when Niels Miller first started building arc welders in 1929, he made sure his products offered long-lasting value and superior quality. Like you, his customers couldn't afford anything less. Miller products had to be more than the best they could be. They had to be the best you could buy.

Today, the people that build and sell Miller products continue the tradition. They're just as committed to providing equipment and service that meets the high standards of quality and value established in 1929.

This Owner's Manual is designed to help you get the most out of your Miller products. Please take time to read the Safety Precautions. They will help you protect yourself against potential hazards on the worksite.



ISO 9001
Quality

Miller is the first welding equipment manufacturer in the U.S.A. to be registered to the ISO 9001 Quality System Standard.

We've made installation and operation quick and easy. With Miller, you can count on years of reliable service with proper maintenance. And if for some reason the unit needs repair, there's a Troubleshooting section that will help you figure out what the problem is, and our extensive service network is there to help fix the problem. Warranty and maintenance information for your particular model are also provided.



Miller Electric manufactures a full line of welders and welding-related equipment. For information on other quality Miller products, contact your local Miller distributor to receive the latest full line catalog or individual specification sheets. **To locate your nearest distributor or service agency call 1-800-4-A-Miller, or visit us at www.MillerWelds.com on the web.**



Working as hard as you do – every power source from Miller is backed by the most hassle-free warranty in the business.



TABLE OF CONTENTS

SECTION 1 – SAFETY PRECAUTIONS - READ BEFORE USING	1
1-1. Symbol Usage	1
1-2. Arc Welding Hazards	1
1-3. Additional Symbols For Installation, Operation, And Maintenance	3
1-4. California Proposition 65 Warnings	4
1-5. Principal Safety Standards	4
1-6. EMF Information	4
SECTION 2 – CONSIGNES DE SÉCURITÉ – LIRE AVANT UTILISATION	5
2-1. Symboles utilisés	5
2-2. Dangers relatifs au soudage à l'arc	5
2-3. Dangers supplémentaires en relation avec l'installation, le fonctionnement et la maintenance	7
2-4. Proposition californienne 65 Avertissements	8
2-5. Principales normes de sécurité	8
2-6. Informations relatives aux CEM	8
SECTION 3 – DEFINITIONS	9
3-1. Additional Safety Symbols And Definitions	9
3-2. Miscellaneous Symbols And Definitions	12
SECTION 4 – SPECIFICATIONS	13
4-1. Serial Number And Rating Label Location	13
4-2. Software Licensing Agreement	13
4-3. Welding Power Source Specifications	13
4-4. Cooler Specifications	14
4-5. Coolant Specifications	14
4-6. Duty Cycle And Overheating	14
4-7. Static Characteristics	15
4-8. Environmental Specifications	15
SECTION 5 – INSTALLATION	16
5-1. Selecting A Location	16
5-2. Dimensions, Weights, And Mounting Options	17
5-3. Selecting Cable Sizes	18
5-4. Connecting Weld Cables, Remote Control, And Shielding Gas	19
5-5. Cooler Connections	20
5-6. Electrical Service Guide	21
5-7. Connecting Three-Phase Input Power	23
5-8. Connecting Single-Phase Input Power	25
5-9. Remote 14 Receptacle Information	26
5-10. Software Updates	27
SECTION 6 – SYNCROWAVE OPERATION	29
6-1. Syncrowave Controls	29
6-2. Accessing Process Menu: AC TIG	30
6-3. Accessing Process Menu: DC TIG And DC TIG Pulse	31
6-4. Accessing Process Menu: DC Stick	31
6-5. Accessing User Menu: AC/DC TIG And DC TIG Pulse	32
6-6. Accessing User Menu: DC Stick	33
SECTION 7 – ADVANCED MENU FUNCTIONS	34
7-1. Accessing Tech Menu	34
7-2. Summary Of Default And Pro-Set Parameters	35
7-3. Output Control And Trigger Functions	36

TABLE OF CONTENTS

SECTION 8 – MAINTENANCE AND TROUBLESHOOTING	37
8-1. Routine Maintenance	37
8-2. Voltmeter/Ammeter Display Messages	38
8-3. Troubleshooting Table	39
8-4. Blowing Out Inside of Unit	40
8-5. Coolant Maintenance	40
SECTION 9 – PARTS LIST	41
9-1. Recommended Spare Parts	41
SECTION 10 – ELECTRICAL DIAGRAM	42
SECTION 11 – HIGH FREQUENCY	43
11-1. Welding Processes Requiring High Frequency	43
11-2. Installation Showing Possible Sources Of HF Interference	43
11-3. Recommended Installation To Reduce HF Interference	44
SECTION 12 – SELECTING AND PREPARING A TUNGSTEN FOR DC OR AC WELDING WITH INVERTER MACHINES	45
12-1. Selecting Tungsten Electrode (Wear Clean Gloves To Prevent Contamination Of Tungsten)	45
12-2. Preparing Tungsten Electrode For DC Electrode Negative (DCEN) Welding Or AC Welding With Inverter Machines	46
SECTION 13 – TIG PROCEDURES	47
13-1. Lift-Arc And HF TIG Start Procedures	47
SECTION 14 – STICK WELDING (SMAW) ELECTRODE AND AMPERAGE SELECTION CHART	48
WARRANTY	
COMPLETE PARTS LIST – Available at www.MillerWelds.com	

SECTION 1 – SAFETY PRECAUTIONS - READ BEFORE USING

som 2018-01

⚠ Protect yourself and others from injury — read, follow, and save these important safety precautions and operating instructions.

1-1. Symbol Usage



DANGER! – Indicates a hazardous situation which, if not avoided, will result in death or serious injury. The possible hazards are shown in the adjoining symbols or explained in the text.



Indicates a hazardous situation which, if not avoided, could result in death or serious injury. The possible hazards are shown in the adjoining symbols or explained in the text.

NOTICE – Indicates statements not related to personal injury.

 Indicates special instructions.



This group of symbols means Warning! Watch Out! ELECTRIC SHOCK, MOVING PARTS, and HOT PARTS hazards. Consult symbols and related instructions below for necessary actions to avoid the hazards.

1-2. Arc Welding Hazards



The symbols shown below are used throughout this manual to call attention to and identify possible hazards. When you see the symbol, watch out, and follow the related instructions to avoid the hazard. The safety information given below is only a summary of the more complete safety information found in the Safety Standards listed in Section 1-5. Read and follow all Safety Standards.



Only qualified persons should install, operate, maintain, and repair this equipment. A qualified person is defined as one who, by possession of a recognized degree, certificate, or professional standing, or who by extensive knowledge, training and experience, has successfully demonstrated ability to solve or resolve problems relating to the subject matter, the work, or the project and has received safety training to recognize and avoid the hazards involved.



During operation, keep everybody, especially children, away.



ELECTRIC SHOCK can kill.

Touching live electrical parts can cause fatal shocks or severe burns. The electrode and work circuit is electrically live whenever the output is on. The input power circuit and machine internal circuits are also live when power is on. In semiautomatic or automatic wire welding, the wire, wire reel, drive roll housing, and all metal parts touching the welding wire are electrically live. Incorrectly installed or improperly grounded equipment is a hazard.

- Do not touch live electrical parts.

- Wear dry, hole-free insulating gloves and body protection.
- Insulate yourself from work and ground using dry insulating mats or covers big enough to prevent any physical contact with the work or ground.
- Do not use AC weld output in damp, wet, or confined spaces, or if there is a danger of falling.
- Use AC output ONLY if required for the welding process.
- If AC output is required, use remote output control if present on unit.
- Additional safety precautions are required when any of the following electrically hazardous conditions are present: in damp locations or while wearing wet clothing; on metal structures such as floors, gratings, or scaffolds; when in cramped positions such as sitting, kneeling, or lying; or when there is a high risk of unavoidable or accidental contact with the workpiece or ground. For these conditions, use the following equipment in order presented: 1) a semiautomatic DC constant voltage (wire) welder, 2) a DC manual (stick) welder, or 3) an AC welder with reduced open-circuit voltage. In most situations, use of a DC, constant voltage wire welder is recommended. And, do not work alone!
- Disconnect input power or stop engine before installing or servicing this equipment. Lockout/tagout input power according to OSHA 29 CFR 1910.147 (see Safety Standards).

- Properly install, ground, and operate this equipment according to its Owner's Manual and national, state, and local codes.
- Always verify the supply ground – check and be sure that input power cord ground wire is properly connected to ground terminal in disconnect box or that cord plug is connected to a properly grounded receptacle outlet.
- When making input connections, attach proper grounding conductor first – double-check connections.
- Keep cords dry, free of oil and grease, and protected from hot metal and sparks.
- Frequently inspect input power cord and ground conductor for damage or bare wiring – replace immediately if damaged – bare wiring can kill.
- Turn off all equipment when not in use.
- Do not use worn, damaged, undersized, or repaired cables.
- Do not drape cables over your body.
- If earth grounding of the workpiece is required, ground it directly with a separate cable.
- Do not touch electrode if you are in contact with the work, ground, or another electrode from a different machine.
- Do not touch electrode holders connected to two welding machines at the same time since double open-circuit voltage will be present.
- Use only well-maintained equipment. Repair or replace damaged parts at once. Maintain unit according to manual.
- Wear a safety harness if working above floor level.
- Keep all panels and covers securely in place.
- Clamp work cable with good metal-to-metal contact to workpiece or worktable as near the weld as practical.
- Insulate work clamp when not connected to workpiece to prevent contact with any metal object.
- Do not connect more than one electrode or work cable to any single weld output terminal. Disconnect cable for process not in use.
- Use GFCI protection when operating auxiliary equipment in damp or wet locations.

SIGNIFICANT DC VOLTAGE exists in inverter welding power sources AFTER removal of input power.

- Turn off unit, disconnect input power, and discharge input capacitors according to instructions in Manual before touching any parts.



HOT PARTS can burn.

- Do not touch hot parts bare handed.
- Allow cooling period before working on equipment.
- To handle hot parts, use proper tools and/or wear heavy, insulated welding gloves and clothing to prevent burns.



FUMES AND GASES can be hazardous.

Welding produces fumes and gases. Breathing these fumes and gases can be hazardous to your health.

- Keep your head out of the fumes. Do not breathe the fumes.
- Ventilate the work area and/or use local forced ventilation at the arc to remove welding fumes and gases. The recommended way to determine adequate ventilation is to sample for the composition and quantity of fumes and gases to which personnel are exposed.
- If ventilation is poor, wear an approved air-supplied respirator.
- Read and understand the Safety Data Sheets (SDSs) and the manufacturer's instructions for adhesives, coatings, cleaners, consumables, coolants, degreasers, fluxes, and metals.
- Work in a confined space only if it is well ventilated, or while wearing an air-supplied respirator. Always have a trained watchperson nearby. Welding fumes and gases can displace air and lower the oxygen level causing injury or death. Be sure the breathing air is safe.
- Do not weld in locations near degreasing, cleaning, or spraying operations. The heat and rays of the arc can react with vapors to form highly toxic and irritating gases.
- Do not weld on coated metals, such as galvanized, lead, or cadmium plated steel, unless the coating is removed from the weld area, the area is well ventilated, and while wearing an air-supplied respirator. The coatings and any metals containing these elements can give off toxic fumes if welded.



ARC RAYS can burn eyes and skin.

Arc rays from the welding process produce intense visible and invisible (ultraviolet and infrared) rays that can burn eyes and skin. Sparks fly off from the weld.

- Wear an approved welding helmet fitted with a proper shade of filter lenses to protect your face and eyes from arc rays and sparks when welding or watching (see ANSI Z49.1 and Z87.1 listed in Safety Standards).
- Wear approved safety glasses with side shields under your helmet.
- Use protective screens or barriers to protect others from flash, glare and sparks; warn others not to watch the arc.
- Wear body protection made from durable, flame-resistant material (leather, heavy cotton, wool). Body protection includes oil-free clothing such as leather gloves, heavy shirt, cuffless trousers, high shoes, and a cap.



WELDING can cause fire or explosion.

Welding on closed containers, such as tanks, drums, or pipes, can cause them to blow up. Sparks can fly off from the welding arc. The flying sparks, hot workpiece, and hot equipment can cause fires and burns. Accidental contact of electrode to metal objects can cause sparks, explosion, overheating, or fire. Check and be sure the area is safe before doing any welding.

- Remove all flammables within 35 ft (10.7 m) of the welding arc. If this is not possible, tightly cover them with approved covers.
- Do not weld where flying sparks can strike flammable material.
- Protect yourself and others from flying sparks and hot metal.
- Be alert that welding sparks and hot materials from welding can easily go through small cracks and openings to adjacent areas.
- Watch for fire, and keep a fire extinguisher nearby.
- Be aware that welding on a ceiling, floor, bulkhead, or partition can cause fire on the hidden side.

- Do not cut or weld on tire rims or wheels. Tires can explode if heated. Repaired rims and wheels can fail. See OSHA 29 CFR 1910.177 listed in Safety Standards.
- Do not weld on containers that have held combustibles, or on closed containers such as tanks, drums, or pipes unless they are properly prepared according to AWS F4.1 and AWS A6.0 (see Safety Standards).
- Do not weld where the atmosphere can contain flammable dust, gas, or liquid vapors (such as gasoline).
- Connect work cable to the work as close to the welding area as practical to prevent welding current from traveling long, possibly unknown paths and causing electric shock, sparks, and fire hazards.
- Do not use welder to thaw frozen pipes.
- Remove stick electrode from holder or cut off welding wire at contact tip when not in use.
- Wear body protection made from durable, flame-resistant material (leather, heavy cotton, wool). Body protection includes oil-free clothing such as leather gloves, heavy shirt, cuffless trousers, high shoes, and a cap.
- Remove any combustibles, such as a butane lighter or matches, from your person before doing any welding.
- After completion of work, inspect area to ensure it is free of sparks, glowing embers, and flames.
- Use only correct fuses or circuit breakers. Do not oversize or bypass them.
- Follow requirements in OSHA 1910.252 (a) (2) (iv) and NFPA 51B for hot work and have a fire watcher and extinguisher nearby.
- Read and understand the Safety Data Sheets (SDSs) and the manufacturer's instructions for adhesives, coatings, cleaners, consumables, coolants, degreasers, fluxes, and metals.

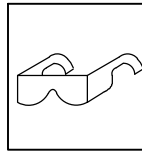

FLYING METAL or DIRT can injure eyes.

- Welding, chipping, wire brushing, and grinding cause sparks and flying metal. As welds cool, they can throw off slag.
- Wear approved safety glasses with side shields even under your welding helmet.



BUILDUP OF GAS can injure or kill.

- Shut off compressed gas supply when not in use.
- Always ventilate confined spaces or use approved air-supplied respirator.

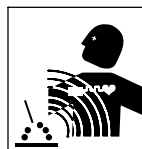

ELECTRIC AND MAGNETIC FIELDS (EMF) can affect Implanted Medical Devices.

- Wearers of Pacemakers and other Implanted Medical Devices should keep away.
- Implanted Medical Device wearers should consult their doctor and the device manufacturer before going near arc welding, spot welding, gouging, plasma arc cutting, or induction heating operations.

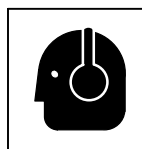

NOISE can damage hearing.

Noise from some processes or equipment can damage hearing.

- Wear approved ear protection if noise level is high.



CYLINDERS can explode if damaged.

Compressed gas cylinders contain gas under high pressure. If damaged, a cylinder can explode. Since gas cylinders are normally part of the welding process, be sure to treat them carefully.

- Protect compressed gas cylinders from excessive heat, mechanical shocks, physical damage, slag, open flames, sparks, and arcs.
- Install cylinders in an upright position by securing to a stationary support or cylinder rack to prevent falling or tipping.
- Keep cylinders away from any welding or other electrical circuits.
- Never drape a welding torch over a gas cylinder.
- Never allow a welding electrode to touch any cylinder.

- Never weld on a pressurized cylinder – explosion will result.
- Use only correct compressed gas cylinders, regulators, hoses, and fittings designed for the specific application; maintain them and associated parts in good condition.
- Turn face away from valve outlet when opening cylinder valve. Do not stand in front of or behind the regulator when opening the valve.
- Keep protective cap in place over valve except when cylinder is in use or connected for use.
- Use the proper equipment, correct procedures, and sufficient number of persons to lift, move, and transport cylinders.
- Read and follow instructions on compressed gas cylinders, associated equipment, and Compressed Gas Association (CGA) publication P-1 listed in Safety Standards.

1-3. Additional Symbols For Installation, Operation, And Maintenance



FIRE OR EXPLOSION hazard.

- Do not install or place unit on, over, or near combustible surfaces.
- Do not install unit near flammables.
- Do not overload building wiring – be sure power supply system is properly sized, rated, and protected to handle this unit.



FALLING EQUIPMENT can injure.

- Use lifting eye to lift unit only, NOT running gear, gas cylinders, or any other accessories.
- Use correct procedures and equipment of adequate capacity to lift and support unit.
- If using lift forks to move unit, be sure forks are long enough to extend beyond opposite side of unit.
- Keep equipment (cables and cords) away from moving vehicles when working from an aerial location.
- Follow the guidelines in the Applications Manual for the Revised NIOSH Lifting Equation (Publication No. 94-110) when manually lifting heavy parts or equipment.

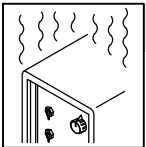

OVERUSE can cause OVERHEATING

- Allow cooling period; follow rated duty cycle.
- Reduce current or reduce duty cycle before starting to weld again.
- Do not block or filter airflow to unit.

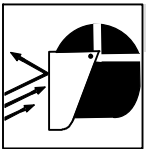

FLYING SPARKS can injure.

- Wear a face shield to protect eyes and face.
- Shape tungsten electrode only on grinder with proper guards in a safe location wearing proper face, hand, and body protection.
- Sparks can cause fires — keep flammables away.

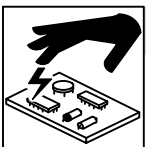

STATIC (ESD) can damage PC boards.

- Put on grounded wrist strap BEFORE handling boards or parts.
- Use proper static-proof bags and boxes to store, move, or ship PC boards.

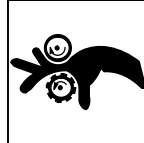

MOVING PARTS can injure.

- Keep away from moving parts.
- Keep away from pinch points such as drive rolls.



WELDING WIRE can injure.

- Do not press gun trigger until instructed to do so.
- Do not point gun toward any part of the body, other people, or any metal when threading welding wire.

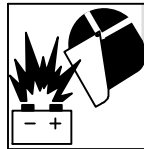

BATTERY EXPLOSION can injure.

- Do not use welder to charge batteries or jump start vehicles unless it has a battery charging feature designed for this purpose.



MOVING PARTS can injure.

- Keep away from moving parts such as fans.
- Keep all doors, panels, covers, and guards closed and securely in place.
- Have only qualified persons remove doors, panels, covers, or guards for maintenance and troubleshooting as necessary.
- Reinstall doors, panels, covers, or guards when maintenance is finished and before reconnecting input power.

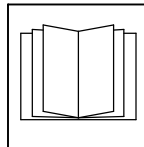

READ INSTRUCTIONS.

- Read and follow all labels and the Owner's Manual carefully before installing, operating, or servicing unit. Read the safety information at the beginning of the manual and in each section.
- Use only genuine replacement parts from the manufacturer.
- Perform installation, maintenance, and service according to the Owner's Manuals, industry standards, and national, state, and local codes.



H.F. RADIATION can cause interference.

- High-frequency (H.F.) can interfere with radio navigation, safety services, computers, and communications equipment.
- Have only qualified persons familiar with electronic equipment perform this installation.
- The user is responsible for having a qualified electrician promptly correct any interference problem resulting from the installation.
- If notified by the FCC about interference, stop using the equipment at once.
- Have the installation regularly checked and maintained.
- Keep high-frequency source doors and panels tightly shut, keep spark gaps at correct setting, and use grounding and shielding to minimize the possibility of interference.

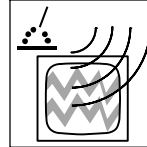

ARC WELDING can cause interference.

- Electromagnetic energy can interfere with sensitive electronic equipment such as computers and computer-driven equipment such as robots.
- Be sure all equipment in the welding area is electromagnetically compatible.
- To reduce possible interference, keep weld cables as short as possible, close together, and down low, such as on the floor.
- Locate welding operation 100 meters from any sensitive electronic equipment.
- Be sure this welding machine is installed and grounded according to this manual.
- If interference still occurs, the user must take extra measures such as moving the welding machine, using shielded cables, using line filters, or shielding the work area.

1-4. California Proposition 65 Warnings

⚠ WARNING: This product can expose you to chemicals including lead, which are known to the state of California to cause cancer and birth defects or other reproductive harm.

For more information, go to www.P65Warnings.ca.gov.

1-5. Principal Safety Standards

Safety in Welding, Cutting, and Allied Processes, ANSI Standard Z49.1, is available as a free download from the American Welding Society at <http://www.aws.org> or purchased from Global Engineering Documents (phone: 1-877-413-5184, website: www.global.ihs.com).

Safe Practices for the Preparation of Containers and Piping for Welding and Cutting, American Welding Society Standard AWS F4.1, from Global Engineering Documents (phone: 1-877-413-5184, website: www.global.ihs.com).

Safe Practices for Welding and Cutting Containers that have Held Combustibles, American Welding Society Standard AWS A6.0, from Global Engineering Documents (phone: 1-877-413-5184, website: www.global.ihs.com).

National Electrical Code, NFPA Standard 70, from National Fire Protection Association, Quincy, MA 02169 (phone: 1-800-344-3555, website: www.nfpa.org and www.sparky.org).

Safe Handling of Compressed Gases in Cylinders, CGA Pamphlet P-1, from Compressed Gas Association, 14501 George Carter Way, Suite 103, Chantilly, VA 20151 (phone: 703-788-2700, website: www.cganet.com).

Safety in Welding, Cutting, and Allied Processes, CSA Standard W117.2, from Canadian Standards Association, Standards Sales, 5060 Spectrum Way, Suite 100, Mississauga, Ontario, Canada L4W 5N5 (phone: 800-463-6727, website: www.csagroup.org).

Safe Practice For Occupational And Educational Eye And Face Protection, ANSI Standard Z87.1, from American National Standards Institute, 25 West 43rd Street, New York, NY 10036 (phone: 212-642-4900, website: www.ansi.org).

Standard for Fire Prevention During Welding, Cutting, and Other Hot Work, NFPA Standard 51B, from National Fire Protection Association, Quincy, MA 02169 (phone: 1-800-344-3555, website: www.nfpa.org).

OSHA, Occupational Safety and Health Standards for General Industry, Title 29, Code of Federal Regulations (CFR), Part 1910.177 Subpart N, Part 1910 Subpart Q, and Part 1926, Subpart J, from U.S. Government Printing Office, Superintendent of Documents, P.O. Box 371954, Pittsburgh, PA 15250-7954 (phone: 1-866-512-1800) (there are 10 OSHA Regional Offices—phone for Region 5, Chicago, is 312-353-2220, website: www.osha.gov).

Applications Manual for the Revised NIOSH Lifting Equation, The National Institute for Occupational Safety and Health (NIOSH), 1600 Clifton Rd, Atlanta, GA 30329-4027 (phone: 1-800-232-4636, website: www.cdc.gov/NIOSH).

1-6. EMF Information

Electric current flowing through any conductor causes localized electric and magnetic fields (EMF). The current from arc welding (and allied processes including spot welding, gouging, plasma arc cutting, and induction heating operations) creates an EMF field around the welding circuit. EMF fields can interfere with some medical implants, e.g. pacemakers. Protective measures for persons wearing medical implants have to be taken. For example, restrict access for passers-by or conduct individual risk assessment for welders. All welders should use the following procedures in order to minimize exposure to EMF fields from the welding circuit:

1. Keep cables close together by twisting or taping them, or using a cable cover.
2. Do not place your body between welding cables. Arrange cables to one side and away from the operator.
3. Do not coil or drape cables around your body.

4. Keep head and trunk as far away from the equipment in the welding circuit as possible.
5. Connect work clamp to workpiece as close to the weld as possible.
6. Do not work next to, sit or lean on the welding power source.
7. Do not weld whilst carrying the welding power source or wire feeder.

About Implanted Medical Devices:

Implanted Medical Device wearers should consult their doctor and the device manufacturer before performing or going near arc welding, spot welding, gouging, plasma arc cutting, or induction heating operations. If cleared by your doctor, then following the above procedures is recommended.

SECTION 2 – CONSIGNES DE SÉCURITÉ – LIRE AVANT UTILISATION

som_2018-01_fre

⚠ Pour écarter les risques de blessure pour vous-même et pour autrui — lire, appliquer et ranger en lieu sûr ces consignes relatives aux précautions de sécurité et au mode opératoire.

2-1. Symboles utilisés



DANGER! – Indique une situation dangereuse qui si on l'évite pas peut donner la mort ou des blessures graves. Les dangers possibles sont montrés par les symboles joints ou sont expliqués dans le texte.



Indique une situation dangereuse qui si on l'évite pas peut donner la mort ou des blessures graves. Les dangers possibles sont montrés par les symboles joints ou sont expliqués dans le texte.

AVIS – Indique des déclarations pas en relation avec des blessures personnelles.

 Indique des instructions spécifiques.



Ce groupe de symboles veut dire Avertissement! Attention! DANGER DE CHOC ÉLECTRIQUE, PIÈCES EN MOUVEMENT, et PIÈCES CHAUDES. Consulter les symboles et les instructions ci-dessous y afférant pour les actions nécessaires afin d'éviter le danger.

2-2. Dangers relatifs au soudage à l'arc



Les symboles représentés ci-dessous sont utilisés dans ce manuel pour attirer l'attention et identifier les dangers possibles. En présence de l'un de ces symboles, prendre garde et suivre les instructions afférentes pour éviter tout risque. Les instructions en matière de sécurité indiquées ci-dessous ne constituent qu'un sommaire des instructions de sécurité plus complètes fournies dans les normes de sécurité énumérées dans la Section 2-5. Lire et observer toutes les normes de sécurité.



L'installation, l'utilisation, l'entretien et les réparations ne doivent être confiés qu'à des personnes qualifiées. Une personne qualifiée est définie comme celle qui, par la possession d'un diplôme reconnu, d'un certificat ou d'un statut professionnel, ou qui, par une connaissance, une formation et une expérience approfondies, a démontré avec succès sa capacité à résoudre les problèmes liés à la tâche, le travail ou le projet et a reçu une formation en sécurité afin de reconnaître et d'éviter les risques inhérents.



Pendant le fonctionnement, maintenir à distance toutes les personnes, notamment les enfants de l'appareil.



UNE DÉCHARGE ÉLECTRIQUE peut entraîner la mort.

Le contact d'organes électriques sous tension peut provoquer des accidents mortels ou des brûlures graves. Le circuit de l'électrode et de la pièce est sous tension lorsque le courant est délivré à la sortie. Le circuit d'alimentation et les circuits internes de la machine sont également sous tension lorsque l'alimentation est sur Marche. Dans le mode de soudage avec du fil, le fil, le dérouleur, le bloc de commande du rouleau et toutes les parties métalliques en contact avec le fil sont sous tension électrique. Un équipement installé ou mis à la terre de manière incorrecte ou impropre constitue un danger.

- Ne pas toucher aux pièces électriques sous tension.
- Porter des gants isolants et des vêtements de protection secs et sans trous.
- S'isoler de la pièce à couper et du sol en utilisant des housses ou des tapis assez grands afin d'éviter tout contact physique avec la pièce à couper ou le sol.
- Ne pas utiliser de sortie de soudage CA dans des zones humides ou confinées ou s'il y a un risque de chute.
- Se servir d'une source électrique à courant électrique UNIQUEMENT si le procédé de soudage le demande.
- Si l'utilisation d'une source électrique à courant électrique s'avère nécessaire, se servir de la fonction de télécommande si l'appareil en est équipé.
- D'autres consignes de sécurité sont nécessaires dans les conditions suivantes : risques électriques dans un environnement humide ou si l'on porte des vêtements mouillés ; sur des structures métalliques telles que sols, grilles ou échafaudages ; en position coincée comme assise, à genoux ou couchée ; ou s'il y a un risque élevé de contact inévitable ou accidentel avec la pièce à souder ou le sol. Dans ces conditions, utiliser les équipements suivants, dans l'ordre indiqué : 1) un poste à souder DC à tension constante (à fil), 2) un poste à souder DC manuel (électrode) ou 3) un poste à souder AC à tension à vide réduite. Dans la plupart des situations,

l'utilisation d'un poste à souder DC à fil à tension constante est recommandée. En outre, ne pas travailler seul !

- Couper l'alimentation ou arrêter le moteur avant de procéder à l'installation, à la réparation ou à l'entretien de l'appareil. Déverrouiller l'alimentation selon la norme OSHA 29 CFR 1910.147 (voir normes de sécurité).
- Installez, mettez à la terre et utilisez correctement cet équipement conformément à son Manuel d'Utilisation et aux réglementations nationales, gouvernementales et locales.
- Toujours vérifier la terre du cordon d'alimentation. Vérifier et s'assurer que le fil de terre du cordon d'alimentation est bien raccordé à la borne de terre du sectionneur ou que la fiche du cordon est raccordée à une prise correctement mise à la terre.
- En effectuant les raccordements d'entrée, fixer d'abord le conducteur de mise à la terre approprié et contre-vérifier les connexions.
- Les câbles doivent être exempts d'humidité, d'huile et de graisse; protégez-les contre les étincelles et les pièces métalliques chaudes.
- Vérifier fréquemment le cordon d'alimentation et le conducteur de mise à la terre afin de s'assurer qu'il n'est pas altéré ou dénudé -, le remplacer immédiatement s'il l'est -. Un fil dénudé peut entraîner la mort.
- L'équipement doit être hors tension lorsqu'il n'est pas utilisé.
- Ne pas utiliser des câbles usés, endommagés, de grosseur insuffisante ou mal épissés.
- Ne pas enrouler les câbles autour du corps.
- Si la pièce soudée doit être mise à la terre, le faire directement avec un câble distinct.
- Ne pas toucher l'électrode quand on est en contact avec la pièce, la terre ou une électrode provenant d'une autre machine.
- Ne pas toucher des porte électrodes connectés à deux machines en même temps à cause de la présence d'une tension à vide doublée.
- N'utiliser qu'un matériel en bon état. Réparer ou remplacer sur-le-champ les pièces endommagées. Entretien l'appareil conformément à ce manuel.
- Porter un harnais de sécurité si l'on doit travailler au-dessus du sol.
- S'assurer que tous les panneaux et couvercles sont correctement en place.
- Fixer le câble de retour de façon à obtenir un bon contact métal-métal avec la pièce à souder ou la table de travail, le plus près possible de la soudure.
- Isoler la pince de masse quand pas mis à la pièce pour éviter le contact avec tout objet métallique.
- Ne pas raccorder plus d'une électrode ou plus d'un câble de masse à une même borne de sortie de soudage. Débrancher le câble pour le procédé non utilisé.
- Utiliser une protection différentielle lors de l'utilisation d'un équipement auxiliaire dans des endroits humides ou mouillés.

Il reste une TENSION DC NON NÉGLIGEABLE dans les sources de soudage onduleur UNE FOIS l'alimentation coupée.

- Éteignez l'unité, débranchez le courant électrique, et déchargez les condensateurs d'alimentation selon les instructions indiquées dans le manuel avant de toucher les pièces.



LES PIÈCES CHAUDES peuvent provoquer des brûlures.

- Ne pas toucher à mains nues les parties chaudes.
- Prévoir une période de refroidissement avant de travailler à l'équipement.

- Ne pas toucher aux pièces chaudes, utiliser les outils recommandés et porter des gants de soudage et des vêtements épais pour éviter les brûlures.



LES FUMÉES ET LES GAZ peuvent être dangereux.

Le soudage génère des fumées et des gaz. Leur inhalation peut être dangereux pour votre santé.

- Eloigner votre tête des fumées. Ne pas respirer les fumées.
- À l'intérieur, ventiler la zone et/ou utiliser une ventilation forcée au niveau de l'arc pour l'évacuation des fumées et des gaz de soudage. Pour déterminer la bonne ventilation, il est recommandé de procéder à un prélèvement pour la composition et la quantité de fumées et de gaz auxquelles est exposé le personnel.
- Si la ventilation est médiocre, porter un respirateur anti-vapeurs approuvé.
- Lire et comprendre les fiches de données de sécurité et les instructions du fabricant concernant les adhésifs, les revêtements, les nettoyants, les consommables, les produits de refroidissement, les dégraisseurs, les flux et les métaux.
- Travailler dans un espace fermé seulement s'il est bien ventilé ou en portant un respirateur à alimentation d'air. Demander toujours à un surveillant dûment formé de se tenir à proximité. Des fumées et des gaz de soudage peuvent déplacer l'air et abaisser le niveau d'oxygène provoquant des blessures ou des accidents mortels. S'assurer que l'air de respiration ne présente aucun danger.
- Ne pas souder dans des endroits situés à proximité d'opérations de dégraissage, de nettoyage ou de pulvérisation. La chaleur et les rayons de l'arc peuvent réagir en présence de vapeurs et former des gaz hautement toxiques et irritants.
- Ne pas souder des métaux munis d'un revêtement, tels que l'acier galvanisé, plaqué en plomb ou au cadmium à moins que le revêtement n'ait été enlevé dans la zone de soudure, que l'endroit soit bien ventilé, et en portant un respirateur à alimentation d'air. Les revêtements et tous les métaux renfermant ces éléments peuvent dégager des fumées toxiques en cas de soudage.



LES RAYONS DE L'ARC peuvent provoquer des brûlures dans les yeux et sur la peau.

Le rayonnement de l'arc du procédé de soudage génère des rayons visibles et invisibles intenses (ultraviolets et infrarouges) susceptibles de provoquer des brûlures dans les yeux et sur la peau. Des étincelles sont projetées pendant le soudage.

- Porter un casque de soudage approuvé muni de verres filtrants appropriés pour protéger visage et yeux pour protéger votre visage et vos yeux pendant le soudage ou pour regarder (voir ANSI Z49.1 et Z87.1 énuméré dans les normes de sécurité).
- Porter des lunettes de sécurité avec écrans latéraux même sous votre casque.
- Avoir recours à des écrans protecteurs ou à des rideaux pour protéger les autres contre les rayonnements les éblouissements et les étincelles ; prévenir toute personne sur les lieux de ne pas regarder l'arc.
- Porter un équipement de protection pour le corps fait d'un matériau résistant et ignifuge (cuir, coton robuste, laine). La protection du corps comporte des vêtements sans huile comme par ex. des gants de cuir, une chemise solide, des pantalons sans revers, des chaussures hautes et une casquette.

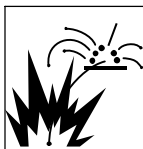

LE SOUDAGE peut provoquer un incendie ou une explosion.

Le soudage effectué sur des conteneurs fermés tels que des réservoirs, tambours ou des conduites peut provoquer leur éclatement. Des étincelles peuvent être projetées de l'arc de soudure. La projection d'étincelles, des pièces chaudes et des équipements chauds peut provoquer des incendies et des brûlures. Le contact accidentel de l'électrode avec des objets métalliques peut provoquer des étincelles, une explosion, un surchauffement ou un incendie. Avant de commencer le soudage, vérifier et s'assurer que l'endroit ne présente pas de danger.

- Déplacer toutes les substances inflammables à une distance de 10,7 m de l'arc de soudage. En cas d'impossibilité les recouvrir soigneusement avec des protections homologués.
- Ne pas souder dans un endroit où des étincelles peuvent tomber sur des substances inflammables.
- Se protéger et d'autres personnes de la projection d'étincelles et de métal chaud.
- Des étincelles et des matériaux chauds du soudage peuvent facilement passer dans d'autres zones en traversant de petites fissures et des ouvertures.
- Surveiller tout déclenchement d'incendie et tenir un extincteur à proximité.
- Le soudage effectué sur un plafond, plancher, paroi ou séparation peut déclencher un incendie de l'autre côté.
- Ne pas couper ou souder des jantes ou des roues. Les pneus peuvent exploser s'ils sont chauffés. Les jantes et les roues réparées peuvent défaillir. Voir OSHA 29 CFR 1910.177 énuméré dans les normes de sécurité.
- Ne pas effectuer le soudage sur des conteneurs fermés tels que des réservoirs, tambours, ou conduites, à moins qu'ils n'aient été préparés correctement conformément à AWS F4.1 et AWS A6.0 (voir les Normes de Sécurité).
- Ne pas souder là où l'air ambiant pourrait contenir des poussières, gaz ou émanations inflammables (vapeur d'essence, par exemple).
- Brancher le câble de masse sur la pièce la plus près possible de la zone de soudage pour éviter le transport du courant sur une longue distance par des chemins inconnus éventuels en provoquant des risques d'électrocution, d'étincelles et d'incendie.
- Ne pas utiliser le poste de soudage pour dégeler des conduites gelées.
- En cas de non utilisation, enlever la baguette d'électrode du porte-électrode ou couper le fil à la pointe de contact.
- Porter un équipement de protection pour le corps fait d'un matériau résistant et ignifuge (cuir, coton robuste, laine). La protection du corps comporte des vêtements sans huile comme par ex. des gants de cuir, une chemise solide, des pantalons sans revers, des chaussures hautes et une casquette.
- Avant de souder, retirer toute substance combustible de vos poches telles qu'un allumeur au butane ou des allumettes.
- Une fois le travail achevé, assurez-vous qu'il ne reste aucune trace d'étincelles incandescentes ni de flammes.
- Utiliser exclusivement des fusibles ou coupe-circuits appropriés. Ne pas augmenter leur puissance; ne pas les ponter.
- Suivre les recommandations dans OSHA 1910.252(a)(2)(iv) et NFPA 51B pour les travaux à chaud et avoir de la surveillance et un extincteur à proximité.
- Lire et comprendre les fiches de données de sécurité et les instructions du fabricant concernant les adhésifs, les revêtements, les nettoyants, les consommables, les produits de refroidissement, les dégraisseurs, les flux et les métaux.

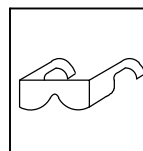

DES PIÈCES DE METAL ou DES SALETES peuvent provoquer des blessures dans les yeux.

- Le soudage, l'écaillage, le passage de la pièce à la brosse en fil de fer, et le meulage génèrent des étincelles et des particules métalliques volantes. Pendant la période de refroidissement des soudures, elles risquent de projeter du laitier.
- Porter des lunettes de sécurité avec écrans latéraux ou un écran facial.



LES ACCUMULATIONS DE GAZ risquent de provoquer des blessures ou même la mort.

- Fermer l'alimentation du gaz comprimé en cas de non utilisation.
- Veiller toujours à bien aérer les espaces confinés ou se servir d'un respirateur d'adduction d'air homologué.



Les CHAMPS ÉLECTROMAGNÉTIQUES (CEM) peuvent affecter les implants médicaux.

- Les porteurs de stimulateurs cardiaques et autres implants médicaux doivent rester à distance.
- Les porteurs d'implants médicaux doivent consulter leur médecin et le fabricant du dispositif avant de s'approcher de la zone où se déroule du soudage à l'arc, du soudage par points, du gougeage, de la découpe plasma ou une opération de chauffage par induction.



LE BRUIT peut endommager l'ouïe.

Le bruit des processus et des équipements peut affecter l'ouïe.

- Porter des protections approuvées pour les oreilles si le niveau sonore est trop élevé.



LES BOUTEILLES peuvent exploser si elles sont endommagées.

Les bouteilles de gaz comprimé contiennent du gaz sous haute pression. Si une bouteille est endommagée, elle peut exploser. Du fait que

les bouteilles de gaz font normalement partie du procédé de soudage, les manipuler avec précaution.

- Protéger les bouteilles de gaz comprimé d'une chaleur excessive, des chocs mécaniques, des dommages physiques, du laitier, des flammes ouvertes, des étincelles et des arcs.
- Placer les bouteilles debout en les fixant dans un support stationnaire ou dans un porte-bouteilles pour les empêcher de tomber ou de se renverser.
- Tenir les bouteilles éloignées des circuits de soudage ou autres circuits électriques.
- Ne jamais placer une torche de soudage sur une bouteille à gaz.
- Une électrode de soudage ne doit jamais entrer en contact avec une bouteille.
- Ne jamais souder une bouteille pressurisée – risque d'explosion.
- Utiliser seulement des bouteilles de gaz comprimé, régulateurs, tuyaux et raccords convenables pour cette application spécifique; les maintenir ainsi que les éléments associés en bon état.
- Tourner le dos à la sortie de vanne lors de l'ouverture de la vanne de la bouteille. Ne pas se tenir devant ou derrière le régulateur lors de l'ouverture de la vanne.
- Le couvercle du détendeur doit toujours être en place, sauf lorsque la bouteille est utilisée ou qu'elle est reliée pour usage ultérieur.
- Utilisez les équipements corrects, les bonnes procédures et suffisamment de personnes pour soulever, déplacer et transporter les bouteilles.
- Lire et suivre les instructions sur les bouteilles de gaz comprimé, l'équipement connexe et le dépliant P-1 de la CGA (Compressed Gas Association) mentionné dans les principales normes de sécurité.

2-3. Dangers supplémentaires en relation avec l'installation, le fonctionnement et la maintenance



Risque D'INCENDIE OU D'EXPLOSION.

- Ne pas placer l'appareil sur, au-dessus ou à proximité de surfaces inflammables.
- Ne pas installer l'appareil à proximité de produits inflammables.
- Ne pas surcharger l'installation électrique – s'assurer que l'alimentation est correctement dimensionnée et protégée avant de mettre l'appareil en service.



LA CHUTE DE L'ÉQUIPEMENT peut provoquer des blessures.

- Utiliser l'anneau de levage uniquement pour soulever l'appareil, NON PAS les chariots, les bouteilles de gaz ou tout autre accessoire.
- Utilisez les procédures correctes et des équipements d'une capacité appropriée pour soulever et supporter l'appareil.
- En utilisant des fourches de levage pour déplacer l'unité, s'assurer que les fourches sont suffisamment longues pour dépasser du côté opposé de l'appareil.
- Tenir l'équipement (câbles et cordons) à distance des véhicules mobiles lors de toute opération en hauteur.
- Suivre les consignes du Manuel des applications pour l'équation de levage NIOSH révisée (Publication N°94-110) lors du levage manuel de pièces ou équipements lourds.

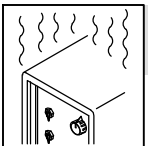

L'EMPLOI EXCESSIF peut SURCHAUFFER L'ÉQUIPEMENT.

- Prévoir une période de refroidissement ; respecter le cycle opératoire nominal.
- Réduire le courant ou le facteur de marche avant de poursuivre le soudage.
- Ne pas obstruer les passages d'air du poste.

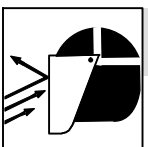

LES ÉTINCELLES PROJÉTÉES peuvent provoquer des blessures.

- Porter un écran facial pour protéger le visage et les yeux.
- Affûter l'électrode au tungstène uniquement à la meuleuse dotée de protecteurs. Cette manœuvre est à exécuter dans un endroit sûr lorsque l'on porte l'équipement homologué de protection du visage, des mains et du corps.
- Les étincelles risquent de causer un incendie – éloigner toute substance inflammable.

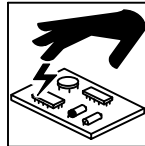

LES CHARGES ÉLECTROSTATIQUES peuvent endommager les circuits imprimés.

- Établir la connexion avec la barrette de terre avant de manipuler des cartes ou des pièces.
- Utiliser des pochettes et des boîtes antistatiques pour stocker, déplacer ou expédier des cartes de circuits imprimés.

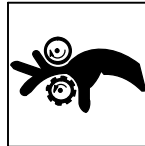

Les PIÈCES MOBILES peuvent causer des blessures.

- Ne pas s'approcher des organes mobiles.
- Ne pas s'approcher des points de coincement tels que des rouleaux de commande.



LES FILS DE SOUDAGE peuvent provoquer des blessures.

- Ne pas appuyer sur la gâchette avant d'en avoir reçu l'instruction.
- Ne pas diriger le pistolet vers soi, d'autres personnes ou toute pièce mécanique en engageant le fil de soudage.

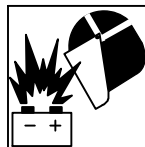

L'EXPLOSION DE LA BATTERIE peut provoquer des blessures.

- Ne pas utiliser l'appareil de soudage pour charger des batteries ou faire démarrer des véhicules à l'aide de câbles de démarrage, sauf si l'appareil dispose d'une fonctionnalité de charge de batterie destinée à cet usage.



Les PIÈCES MOBILES peuvent causer des blessures.

- S'abstenir de toucher des organes mobiles tels que des ventilateurs.
- Maintenir fermés et verrouillés les portes, panneaux, recouvrements et dispositifs de protection.
- Lorsque cela est nécessaire pour des travaux d'entretien et de dépannage, faire retirer les portes, panneaux, recouvrements ou dispositifs de protection uniquement par du personnel qualifié.
- Remettre les portes, panneaux, recouvrements ou dispositifs de protection quand l'entretien est terminé et avant de rebrancher l'alimentation électrique.

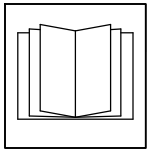

LIRE LES INSTRUCTIONS.

- Lire et appliquer les instructions sur les étiquettes et le Mode d'emploi avant l'installation, l'utilisation ou l'entretien de l'appareil. Lire les informations de sécurité au début du manuel et dans chaque section.

- N'utiliser que les pièces de rechange recommandées par le constructeur.
- Effectuer l'installation, l'entretien et toute intervention selon les manuels d'utilisateurs, les normes nationales, provinciales et de l'industrie, ainsi que les codes municipaux.

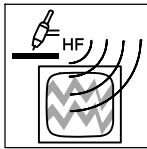

LE RAYONNEMENT HAUTE FRÉQUENCE (H.F.) risque de provoquer des interférences.

- Le rayonnement haute fréquence (H.F.) peut provoquer des interférences avec les équipements de radio-navigation et de communication, les services de sécurité et les ordinateurs.
- Demander seulement à des personnes qualifiées familiarisées avec des équipements électroniques de faire fonctionner l'installation.
- L'utilisateur est tenu de faire corriger rapidement par un électricien qualifié les interférences résultant de l'installation.
- Si le FCC signale des interférences, arrêter immédiatement l'appareil.

- Effectuer régulièrement le contrôle et l'entretien de l'installation.
- Maintenir soigneusement fermés les portes et les panneaux des sources de haute fréquence, maintenir les éclateurs à une distance correcte et utiliser une terre et un blindage pour réduire les interférences éventuelles.

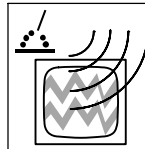

LE SOUDAGE À L'ARC risque de provoquer des interférences.

- L'énergie électromagnétique risque de provoquer des interférences pour l'équipement électronique sensible tel que les ordinateurs et l'équipement commandé par ordinateur tel que les robots.
- Veiller à ce que tout l'équipement de la zone de soudage soit compatible électromagnétiquement.
- Pour réduire la possibilité d'interférence, maintenir les câbles de soudage aussi courts que possible, les grouper, et les poser aussi bas que possible (ex. par terre).
- Veiller à souder à une distance de 100 mètres de tout équipement électronique sensible.
- Veiller à ce que ce poste de soudage soit posé et mis à la terre conformément à ce mode d'emploi.
- En cas d'interférences après avoir pris les mesures précédentes, il incombe à l'utilisateur de prendre des mesures supplémentaires telles que le déplacement du poste, l'utilisation de câbles blindés, l'utilisation de filtres de ligne ou la pose de protecteurs dans la zone de travail.

2-4. Proposition californienne 65 Avertissements

⚠ AVERTISSEMENT : ce produit peut vous exposer à des produits chimiques tels que le plomb, reconnus par l'État de Californie comme cancérigènes et sources de malformations ou d'autres troubles de la reproduction.

Pour plus d'informations, consulter www.P65Warnings.ca.gov.

2-5. Principales normes de sécurité

Safety in Welding, Cutting, and Allied Processes, ANSI Standard Z49.1, is available as a free download from the American Welding Society at <http://www.aws.org> or purchased from Global Engineering Documents (phone: 1-877-413-5184, website: www.global.ih.com).

Safe Practices for the Preparation of Containers and Piping for Welding and Cutting, American Welding Society Standard AWS F4.1, from Global Engineering Documents (phone: 1-877-413-5184, website: www.global.ih.com).

Safe Practices for Welding and Cutting Containers that have Held Combustibles, American Welding Society Standard AWS A6.0, from Global Engineering Documents (phone: 1-877-413-5184, website: www.global.ih.com).

National Electrical Code, NFPA Standard 70, from National Fire Protection Association, Quincy, MA 02169 (phone: 1-800-344-3555, website: www.nfpa.org and www.sparky.org).

Safe Handling of Compressed Gases in Cylinders, CGA Pamphlet P-1, from Compressed Gas Association, 14501 George Carter Way, Suite 103, Chantilly, VA 20151 (phone: 703-788-2700, website: www.cganet.com).

Safety in Welding, Cutting, and Allied Processes, CSA Standard W117.2, from Canadian Standards Association, Standards Sales, 5060 Spec-

trum Way, Suite 100, Mississauga, Ontario, Canada L4W 5N5 (phone: 800-463-6727, website: www.csagroup.org).

Safe Practice For Occupational And Educational Eye And Face Protection, ANSI Standard Z87.1, from American National Standards Institute, 25 West 43rd Street, New York, NY 10036 (phone: 212-642-4900, website: www.ansi.org).

Standard for Fire Prevention During Welding, Cutting, and Other Hot Work, NFPA Standard 51B, from National Fire Protection Association, Quincy, MA 02169 (phone: 1-800-344-3555, website: www.nfpa.org).

OSHA, Occupational Safety and Health Standards for General Industry, Title 29, Code of Federal Regulations (CFR), Part 1910.177 Subpart N, Part 1910 Subpart Q, and Part 1926, Subpart J, from U.S. Government Printing Office, Superintendent of Documents, P.O. Box 371954, Pittsburgh, PA 15250-7954 (phone: 1-866-512-1800) (there are 10 OSHA Regional Offices—phone for Region 5, Chicago, is 312-353-2220, website: www.osha.gov).

Applications Manual for the Revised NIOSH Lifting Equation, The National Institute for Occupational Safety and Health (NIOSH), 1600 Clifton Rd, Atlanta, GA 30329-4027 (phone: 1-800-232-4636, website: www.cdc.gov/NIOSH).

2-6. Informations relatives aux CEM

Le courant électrique qui traverse tout conducteur génère des champs électromagnétiques (CEM) à certains endroits. Le courant issu d'un soudage à l'arc (et de procédés connexes, y compris le soudage par points, le gougeage, le découpage plasma et les opérations de chauffage par induction) crée un champ électromagnétique (CEM) autour du circuit de soudage. Les champs électromagnétiques produits peuvent causer interférence à certains implants médicaux, p. ex. les stimulateurs cardiaques. Des mesures de protection pour les porteurs d'implants médicaux doivent être prises: Limiter par exemple tout accès aux passants ou procéder à une évaluation des risques individuels pour les soudeurs. Tous les soudeurs doivent appliquer les procédures suivantes pour minimiser l'exposition aux CEM provenant du circuit de soudage:

1. Rassembler les câbles en les torsadant ou en les attachant avec du ruban adhésif ou avec une housse.
2. Ne pas se tenir au milieu des câbles de soudage. Disposer les

câbles d'un côté et à distance de l'opérateur.

3. Ne pas courber et ne pas entourer les câbles autour de votre corps.
4. Maintenir la tête et le torse aussi loin que possible du matériel du circuit de soudage.
5. Connecter la pince sur la pièce aussi près que possible de la soudure.
6. Ne pas travailler à proximité d'une source de soudage, ni s'asseoir ou se pencher dessus.
7. Ne pas souder tout en portant la source de soudage ou le dévidoir.







En ce qui concerne les implants médicaux :





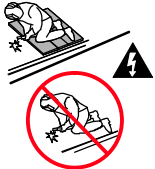
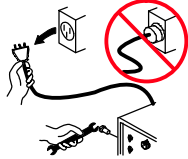

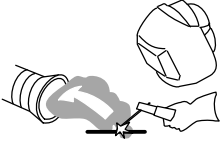
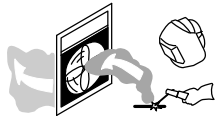
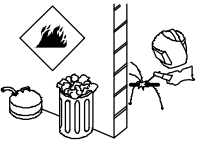
Les porteurs d'implants doivent d'abord consulter leur médecin avant de s'approcher des opérations de soudage à l'arc, de soudage par points, de gougeage, du coupage plasma ou de chauffage par induction. Si le médecin approuve, il est recommandé de suivre les procédures précédentes.

SECTION 3 – DEFINITIONS

3-1. Additional Safety Symbols And Definitions

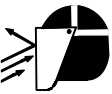

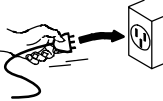
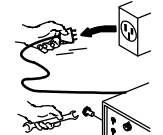

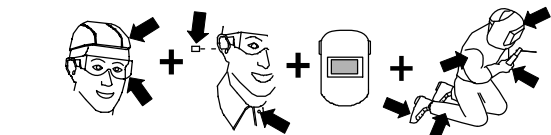
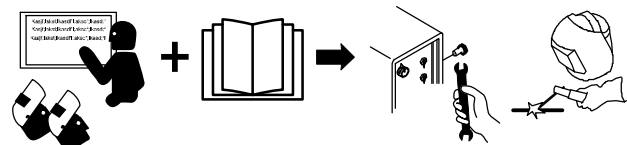

 Some symbols are found only on CE products.







	<p>Warning! Watch Out! There are possible hazards as shown by the symbols.</p> <p style="text-align: right;">Safe1 2012-05</p>
	<p>Wear dry insulating gloves. Do not touch electrode with bare hand. Do not wear wet or damaged gloves.</p> <p style="text-align: right;">Safe2 2017-04</p>
	<p>Protect yourself from electric shock by insulating yourself from work and ground.</p> <p style="text-align: right;">Safe3 2017-04</p>
	<p>Disconnect input plug or power before working on machine.</p> <p style="text-align: right;">Safe5 2017-04</p>
	<p>Keep your head out of the fumes.</p> <p style="text-align: right;">Safe6 2017-04</p>
	<p>Use forced ventilation or local exhaust to remove the fumes.</p> <p style="text-align: right;">Safe8 2012-05</p>
	<p>Use ventilating fan to remove fumes.</p> <p style="text-align: right;">Safe10 2012-05</p>
	<p>Keep flammables away from welding. Do not weld near flammables.</p> <p style="text-align: right;">Safe12 2012-05</p>
	<p>Welding sparks can cause fires. Have a fire extinguisher nearby, and have a watchperson ready to use it.</p> <p style="text-align: right;">Safe14 2012-05</p>





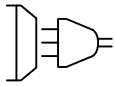

	<p>Do not weld on drums or any closed containers.</p> <p style="text-align: right;">Safe16 2017-04</p>
	<p>Do not remove or paint over (cover) the label.</p> <p style="text-align: right;">Safe20 2017-04</p>
	<p>When power is applied failed parts can explode or cause other parts to explode.</p> <p style="text-align: right;">Safe26 2012-05</p>
	<p>Flying pieces of parts can cause injury. Always wear a face shield when servicing unit.</p> <p style="text-align: right;">Safe27 2012-05</p>
	<p>Always wear long sleeves and button your collar when servicing unit.</p> <p style="text-align: right;">Safe28 2012-05</p>
	<p>After taking proper precautions as shown, connect power to unit.</p> <p style="text-align: right;">Safe29 2012-05</p>
	<p>Disconnect input plug or power before working on machine.</p> <p style="text-align: right;">Safe30 2012-05</p>
	<p>Do not use one handle to lift or support unit.</p> <p style="text-align: right;">Safe31 2017-04</p>
	<p>Do not discard product (where applicable) with general waste. Reuse or recycle Waste Electrical and Electronic Equipment (WEEE) by disposing at a designated collection facility. Contact your local recycling office or your local distributor for further information.</p> <p style="text-align: right;">Safe37 2017-04</p>
	<p>Wear hat and safety glasses. Use ear protection and button shirt collar. Use welding helmet with correct shade of filter. Wear complete body protection.</p> <p style="text-align: right;">Safe38 2012-05</p>
	<p>Become trained and read the instructions before working on the machine or welding.</p> <p style="text-align: right;">Safe40 2012-05</p>

	<p>Hazardous voltage remains on input capacitors after power is turned off. Do not touch fully charged capacitors. Always wait 60 seconds after power is turned off before working on unit, AND check input capacitor voltage, and be sure it is near 0 before touching any parts.</p> <p style="text-align: right;">Safe42 2017-04</p>
	<p>Always lift and support unit using both handles. Keep angle of lifting device less than 60 degrees.</p> <p>Use a proper cart to move unit.</p> <p style="text-align: right;">Safe44 2012-05</p>
	<p>Plugged filter or hoses can cause overheating to the power source and torch.</p> <p style="text-align: right;">Safe50 2012-05</p>
	<p>Every 100 hours, check and clean filter and check condition of hoses.</p> <p style="text-align: right;">Safe51 2012-05</p>
	<p>Use coolant suggested by the manufacturer.</p> <p style="text-align: right;">Safe52 2012-05</p>
	<p>Welding current creates an electric and magnetic field (EMF) around the welding circuit and welding equipment.</p> <p style="text-align: right;">Safe72 2012-06</p>
	<p>Recycle.</p> <p style="text-align: right;">Safe103 2012-09</p>
	<p>Environmental Protection Use Period (China)</p> <p style="text-align: right;">Safe123 2016-06</p>

3-2. Miscellaneous Symbols And Definitions

A	Amperes
	Gas Tungsten Arc Welding (GTAW)
	Shielded Metal Arc Welding (SMAW)
V	Volts
	Voltage Input
	3 Phase Static Frequency Converter-Transformer-Rectifier
	Voltage Output
	Remote
	Protective Earth (Ground)
S	Seconds
I	On
O	Off
+	Positive
-	Negative

	Alternating Current
	Water (Coolant) Input
	Water (Coolant) Output
	Cooling
	Gas Input
	Gas Output
I₂	Rated Welding Current
X	Duty Cycle
	Direct Current
	Line Connection
U₂	Conventional Load Voltage
U₁	Primary Voltage
IP	Degree Of Protection
I_{1max}	Rated Maximum Supply Current

I_{1eff}	Maximum Effective Supply Current
U₀	Rated No Load Voltage (OCV)
P₁	Rated Cooling Power (Coolers)
p_{max}	Rated Maximum Pressure (Coolers)
	Pulse Background Amperage
	Initial Amperage
	Increase/Decrease Of Quantity
%	Percent
Hz	Hertz
	Pulse Frequency
	Process
	Pulser
	Output
S	Suitable For Areas Of Increased Shock Hazard

SECTION 4 – SPECIFICATIONS

4-1. Serial Number And Rating Label Location

The serial number and rating information for the power source is located on the rear of the machine. Use the rating labels to determine input power requirements and/or rated output. For future reference, write serial number in space provided on back cover of this manual.

4-2. Software Licensing Agreement

The End User License Agreement and any third-party notices and terms and conditions pertaining to third-party software can be found at <https://www.millerwelds.com/eula> and are incorporated by reference herein.

4-3. Welding Power Source Specifications

☞ This equipment will deliver rated output at an ambient air temperature up to 104 °F (40 °C).

☞ Do not use information in unit specifications table to determine electrical service requirements. See Sections 5-6, 5-7 and 5-8 for information on connecting input power.

Welding Amperage Range	Max Open Circuit Voltage (Uo)	Low Open-Circuit Voltage (Uo)	Rated Peak Striking Voltage (Up)
5-300*	60	8-15***	14KV**

*Welding range for Stick process is 5-230 amperes. For TIG, the amperage range is tungsten diameter dependent (see Sections 6-5) depending on model.
 ** Arc starting device is designed for manual guided operations.
 *** Low open-circuit voltage while in TIG Lift Arc™, or while in Stick with low open-circuit voltage selected.

Process	Output Ratings			Phase	Current Draw (A) At Rate Input Voltages (V)			Input Power	
	Current (A)	Voltage (V)	Duty Cycle		208V	240V	480V	kW	kVA
STICK	230	28.4	30%	1	44	37	18	8.8	9
				3	25	22	11	8.6	8.9
	160	26.4	60%	1	27	23	11	5.5	5.7
				3	16	11	5	5.5	5.7
	125	25	100%	1	20	18	9	4.1	4.2
				3	12	10	5	4.2	4.3
TIG*	300	22	30%	3	47	41	19	9.4	9.7
				3	27	23	11	9.2	9.7
	210	18.4	60%	1	27	24	12	5.5	5.7
				3	16	14	7	5.5	5.9
	175	17	100%	3	13	11	6	4.3	4.8
				3	13	11	6	4.3	4.8
					Power Draw (W)				
Idle OCV	0	60	–	1	90	89	116	–	–
Idle OCV	0	60	–	3	94	94	131	–	–
Idle w/ Output Off	–	–	–	1	29	30	63	–	–
				3	31	34	64	–	–
Idle Cooler On	–	–	–	1	189	211	250	–	–
				3	197	221	278	–	–

*Includes cooler power draw.

4-4. Cooler Specifications

The correction factor on the cooling power at an ambient temperature of 104 °F (40 °C) is 0.625.

Recirculating Coolant System For Water-Cooled GTAW Torches And GMAW Guns	
Use With Guns/Torches Rated Up To 600 Amperes	
Coolant Tank Capacity	3 gal (11.4 L)
Rated Cooling Power	1.42 kW at 1.1 qt/min at 77°F (4,840 BTU/hr at 1 L/min at 25°C)

4-5. Coolant Specifications



⚠ Do not use conductive coolant.

Application	Coolant
GTAW Or Where High Frequency Current Is Used	Low Conductivity Coolant 043810* Distilled Or Deionized Water Okay Above 32°F (0°C)

*Coolants 043810 and 043809 protect to -37°F (-38°C) and resist algae growth.

NOTICE – Use of any coolant other than those listed in the table voids the warranty on any parts that come in contact with the coolant (pump, radiator, etc.).

4-6. Duty Cycle And Overheating

Duty Cycle is percentage of 10 minutes that unit can weld at rated load without overheating. If unit overheats, output stops, a Help message is displayed (see Section 8-2), and cooling fan runs. Wait fifteen minutes for unit to cool. Reduce amperage or voltage, or duty cycle before welding.

NOTICE – Exceeding duty cycle can damage machine or torch and void warranty.

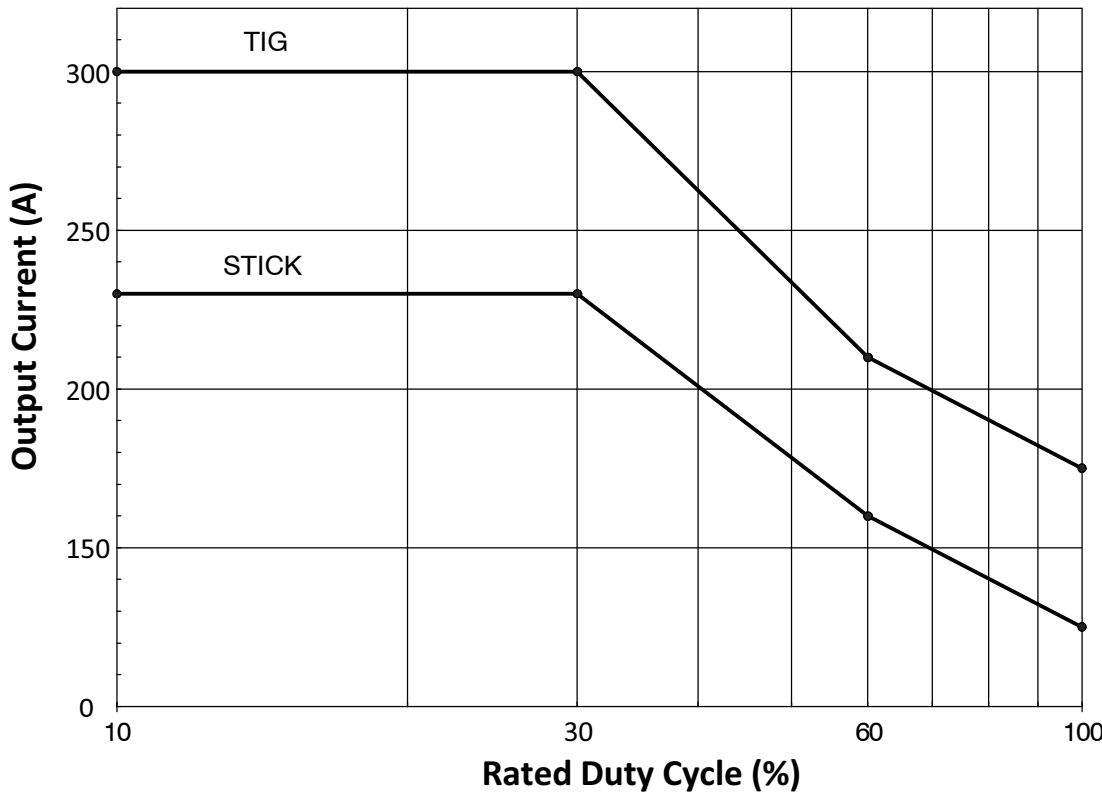

Rated Duty Cycle (%)	TIG Output Current (A)	STICK Output Current (A)
10	300	230
30	300	230
60	210	160
100	175	125

Overheating

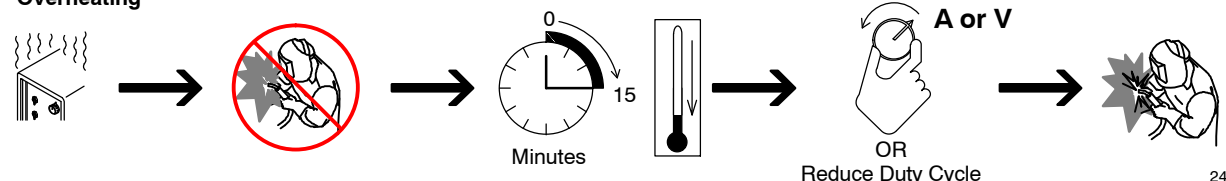

Minutes A or V OR Reduce Duty Cycle

SECTION 5 – INSTALLATION

5-1. Selecting A Location

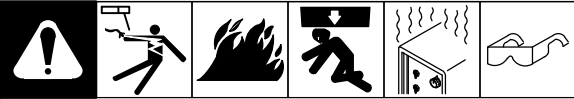

Movement

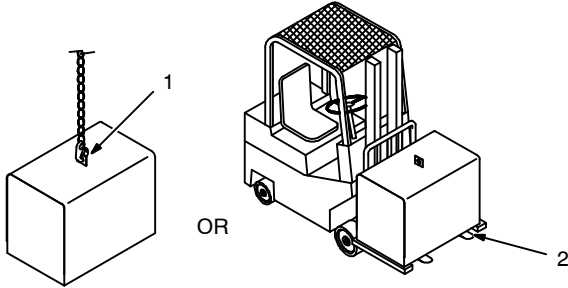

⚠ Do not move or operate unit where it could tip.

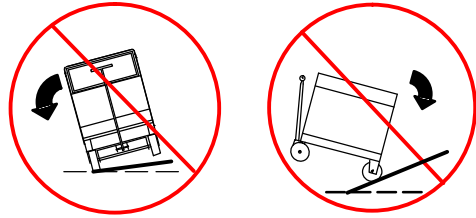

Location And Airflow

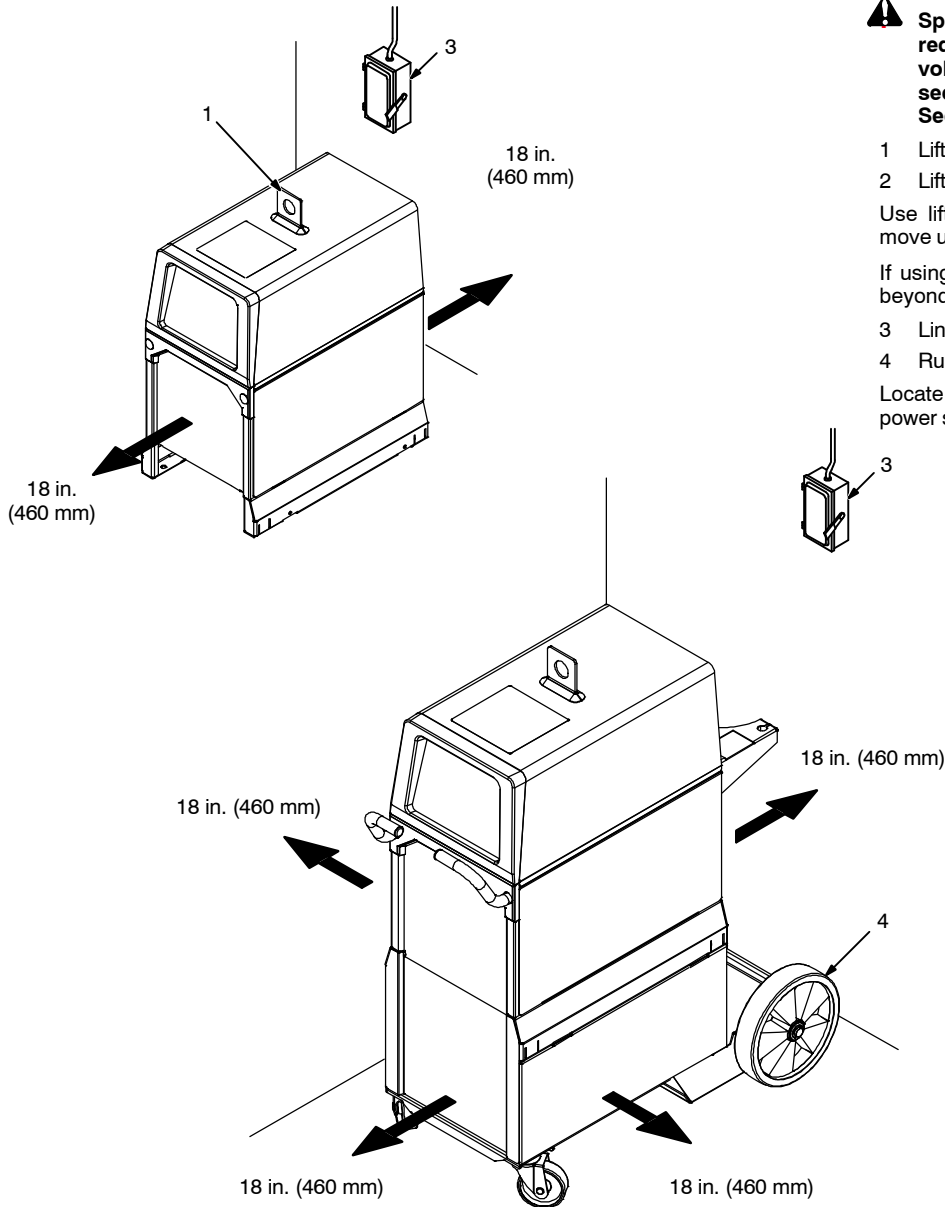

⚠ Special installation may be required where gasoline or volatile liquids are present – see NEC Article 511 or CEC Section 20.

- 1 Lifting Eye
- 2 Lifting Forks

Use lifting eye or lifting forks to move unit.

If using lifting forks, extend forks beyond opposite side of unit.

- 3 Line Disconnect Device
- 4 Running Gear

Locate unit near correct input power supply.

5-2. Dimensions, Weights, And Mounting Options

A. Welding Power Source

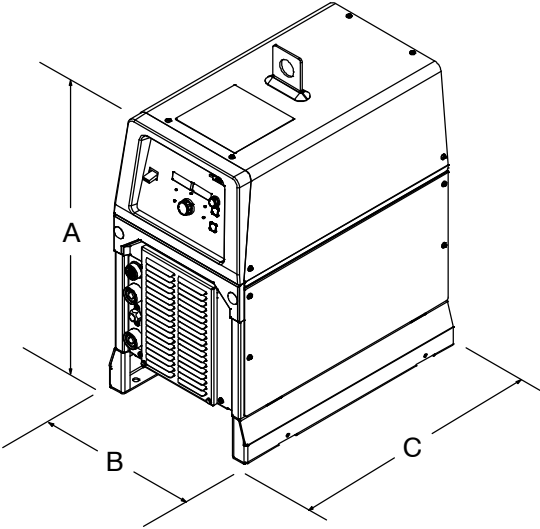
 <p style="text-align: right;">Ref. 805617-A</p>	Dimensions	
	A	29-3/8 in. (746 mm)
	B	15 in. (381 mm)
	C	24-5/8 in. (625 mm)
Weight		101 lb (45.8 kg)

B. Welding Power Source With Cart And Cooler

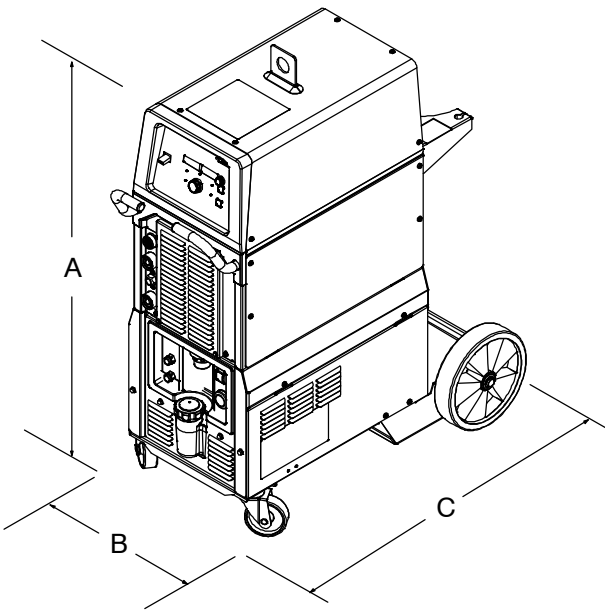
 <p style="text-align: right;">Ref. 805617-A</p>	Dimensions	
	A	43-7/8 in. (1114 mm)
	B	20-1/2 in. (521 mm)
	C	36 1/4 in. (921 mm)
Weight Empty		178 lb (80.1 kg)

C. Mounting Options

<p style="text-align: right;">805620-A</p>	Dimensions	
	A	19-1/2 in. (495 mm)
	B	2 in. (51 mm)
	C	4 x .500 in. Dia. (13 mm) Base
	D	1 in. (25 mm)
	E	13 in. (330 mm)

5-3. Selecting Cable Sizes*

NOTICE – The Total Cable Length in Weld Circuit (see table below) is the combined length of both weld cables. For example, if the power source is 100 ft (30 m) from the workpiece, the total cable length in the weld circuit is 200 ft (2 cables x 100 ft). Use the 200 ft (60 m) column to determine cable size.

Welding Amperes***	Weld Cable Size** and Total Cable (Copper) Length in Weld Circuit Not Exceeding			
	100 ft (30 m) or Less****		150 ft (45 m)	200 ft (60 m)
	10 – 60% Duty Cycle AWG (mm ²)	60 – 100% Duty Cycle AWG (mm ²)	10 – 100% Duty Cycle AWG (mm ²)	
100	4 (20)	4 (20)	4 (20)	3 (30)
150	3 (30)	3 (30)	2 (35)	1 (50)
200	3 (30)	2 (35)	1 (50)	1/0 (60)
250	2 (35)	1 (50)	1/0 (60)	2/0 (70)
300	1 (50)	1/0 (60)	2/0 (70)	3/0 (95)
350	1/0 (60)	2/0 (70)	3/0 (95)	4/0 (120)
400	1/0 (60)	2/0 (70)	3/0 (95)	4/0 (120)
500	2/0 (70)	3/0 (95)	4/0 (120)	2x2/0 (2x70)

* This chart is a general guideline and may not suit all applications. If cable overheats, use next size larger cable.

**Weld cable size (AWG) is based on either a 4 volts or less drop or a current density of at least 300 circular mils per ampere. () = mm² for metric use.

***For distances longer than those shown in this guide, see AWS Fact Sheet No. 39, Welding Cables, available from the American Welding Society at <http://www.aws.org>.

***Select weld cable size for pulsing application at peak amperage value.

****For distances longer than 100 ft (30 m) and up to 200 ft (60 m), use direct current (DC) output only. For distances longer than those shown in this guide, see AWS Fact Sheet No. 39, Welding Cables, available from the American Welding Society at <http://www.aws.org>.

Ref. S-0007-M 2017-08 (TIG)

5-4. Connecting Weld Cables, Remote Control, And Shielding Gas



⚠ Turn off power before connecting to weld output terminals.

⚠ Do not use worn, damaged, undersized, or repaired cables.

Connections

1 Remote Control Receptacle
(See Section 5-9)

2 Electrode Weld Output Terminal
For stick (SMAW), connect electrode holder to this terminal.

3 Gas Out Connection
Requires an 11/16 in. wrench.

4 Work Weld Output Terminal
Connect work clamp to this terminal.

For TIG (GTAW), connect torch to this terminal.

5 Gas In Connection

Fitting has 5/8-18 in. right hand threads, and usually requires an 11/16 in. wrench. Maximum psi is 125 kPa.

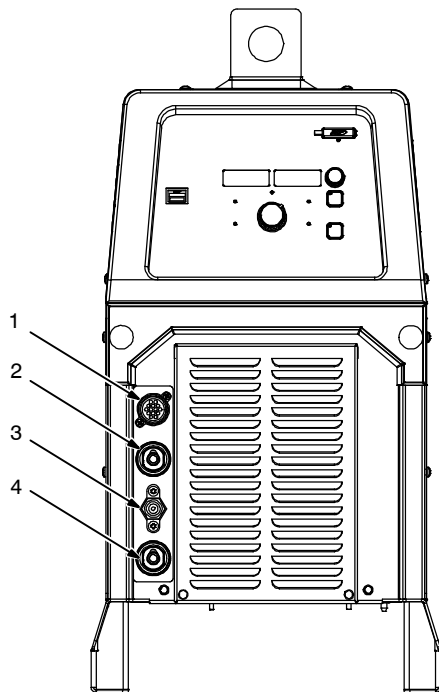

Syncrowave Front Panel

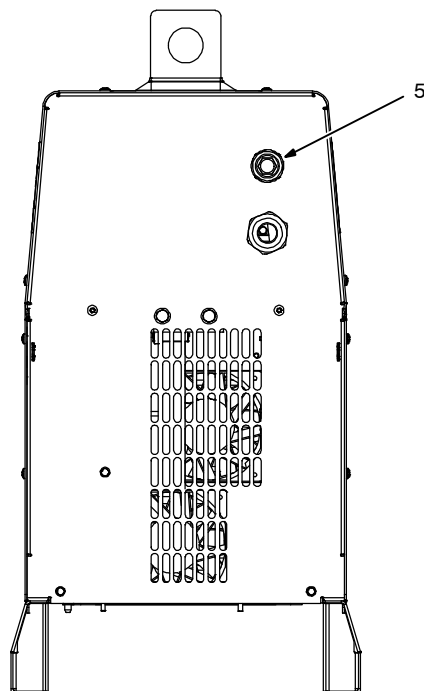

Rear Panel

Tools Needed:

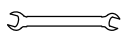

11/16 in.

Ref. 805618-A

5-5. Cooler Connections



Cart and cooler are optional equipment.

1 Electrode Weld Output Terminal
Connect TIG torch to this terminal.

2 Gas Out Connection
Connect TIG torch gas hose to gas out fitting.

3 Work Weld Output Terminal
Connect work lead to this terminal.

4 Water-Out (To Torch) Connection
Connect torch water supply (blue) hose to the coolers water-out connection.

5 Water-In (From Torch) Connection
Connect torch water return (red) hose to the coolers water-in connection.

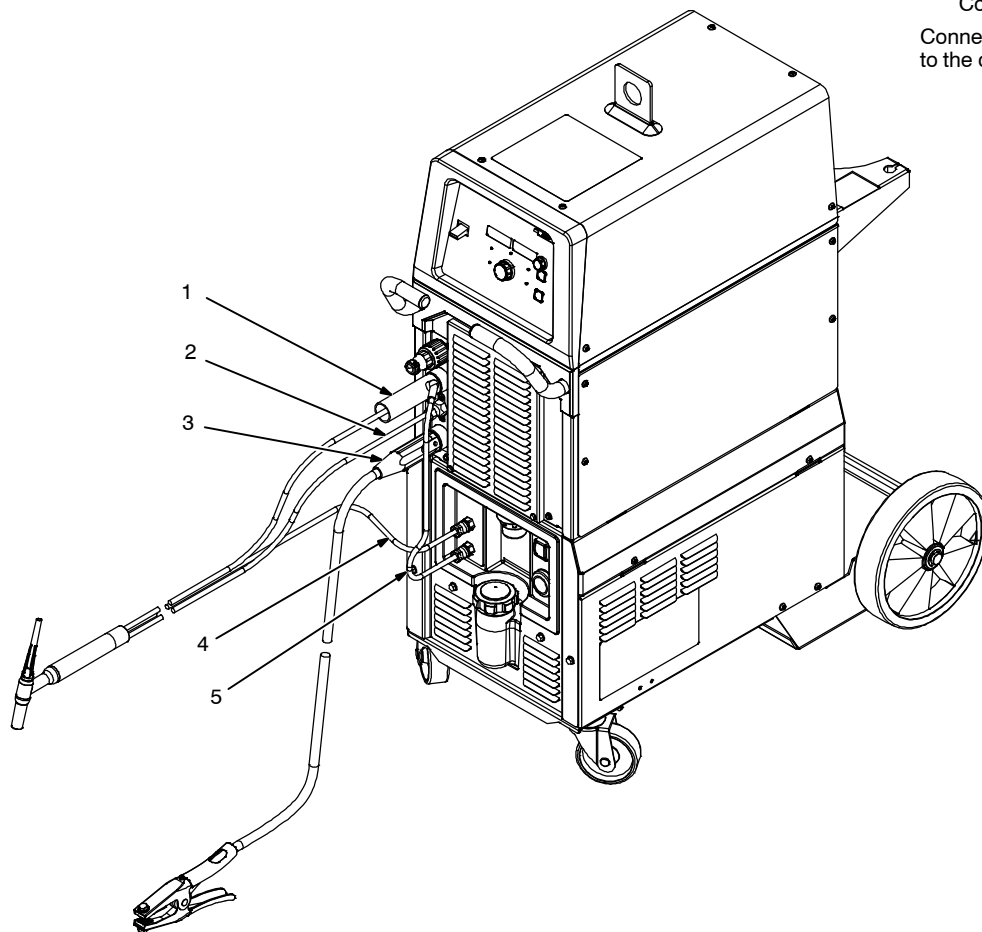

Tools Needed:

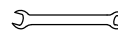

11/16 in.

Application	GTAW Or Where HF* Is Used
 1-1/4 Gal Coolant	Low Conductivity Coolant No. 043 810**; Distilled Or Deionized Water OK Above 32° F (0° C)

*HF: High Frequency Current

**Coolant 043 810, a 50/50 solution, protect to -37° F (-38° C) and resist algae growth.

NOTICE - Use of any coolant other than those listed in the table voids the warranty on any parts that come in contact with the coolant (pump, radiator, etc.).

5-7. Connecting Three-Phase Input Power

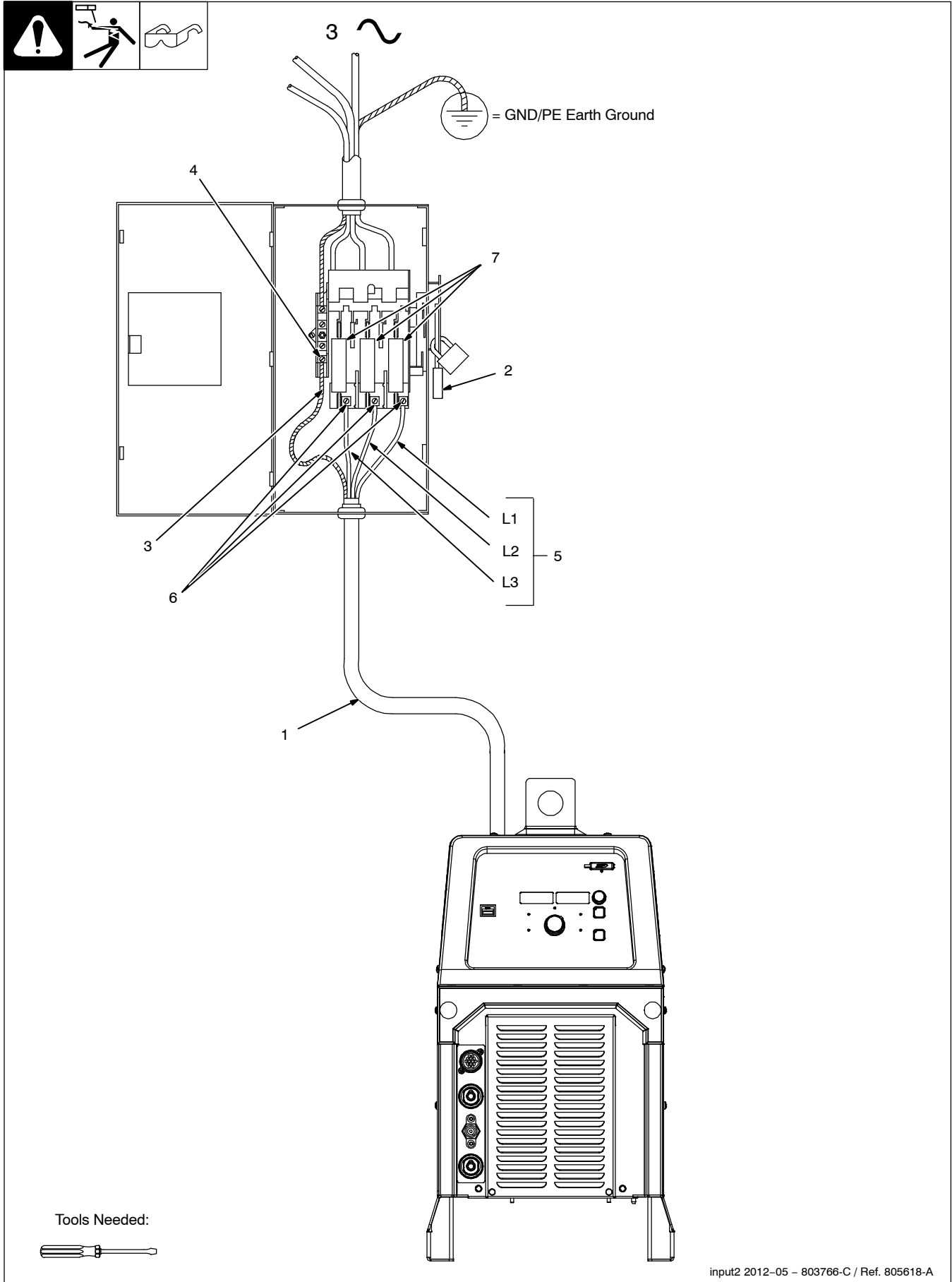

input2 2012-05 - 803766-C / Ref. 805618-A

5-8. Connecting Single-Phase Input Power

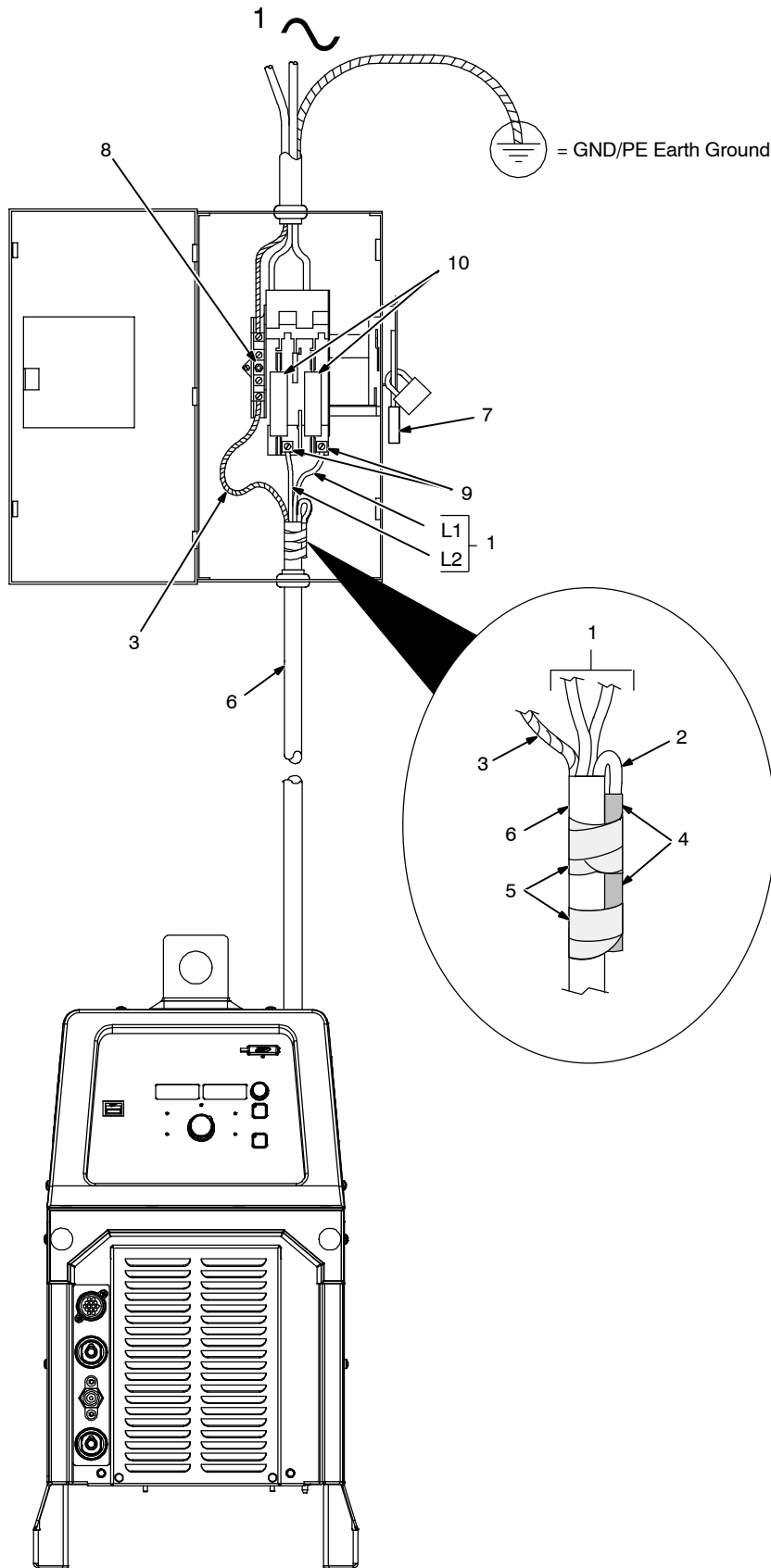

⚠ Installation must meet all National and Local Codes – have only qualified persons make this installation.

⚠ Disconnect and lockout/tagout input power before connecting input conductors from unit. Follow established procedures regarding the installation and removal of lockout/tagout devices.

⚠ Always connect green or green/yellow conductor to supply grounding terminal first, and never to a line terminal.

See rating label on unit and check input voltage available at site.

- 1 Black And White Input Conductor (L1 And L2)
- 2 Red Input Conductor
- 3 Green Or Green/Yellow Grounding Conductor
- 4 Insulation Sleeving
- 5 Electrical Tape

Insulate and isolate red conductor as shown.

- 6 Input Power Cord.
- 7 Disconnect Device (switch shown in the OFF position)
- 8 Disconnect Device Grounding Terminal
- 9 Disconnect Device Line Terminals

Connect green or green/yellow grounding conductor to disconnect device grounding terminal first.

Connect input conductors L1 and L2 to disconnect device line terminals.

- 10 Overcurrent Protection

Select type and size of overcurrent protection using Section 5-6 (fused disconnect switch shown).

Close and secure door on disconnect device. Follow established lockout/tagout procedures to put unit in service.

Tools Needed:





5-10. Software Updates

A. Reasons For Downloads Of Software Updates

- To get the latest feature and software improvements with future software updates.
- For all circuit board replacements, a software update is required to ensure proper unit operation.
- A software update is required to ensure proper software expansion operation of all purchased feature expansions.

B. Requirements



 A computer with an SD memory card port, or SD memory card reader is required to download software updates.

The SD logo is a registered trademark of SD-3C LLC.

C. How To Download Software Updates

1. On your web browser, go to <https://www.millerwelds.com/support/software/tig-software>.
2. Select System Installation Instructions (PDF) and follow the instructions.

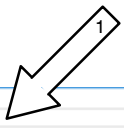

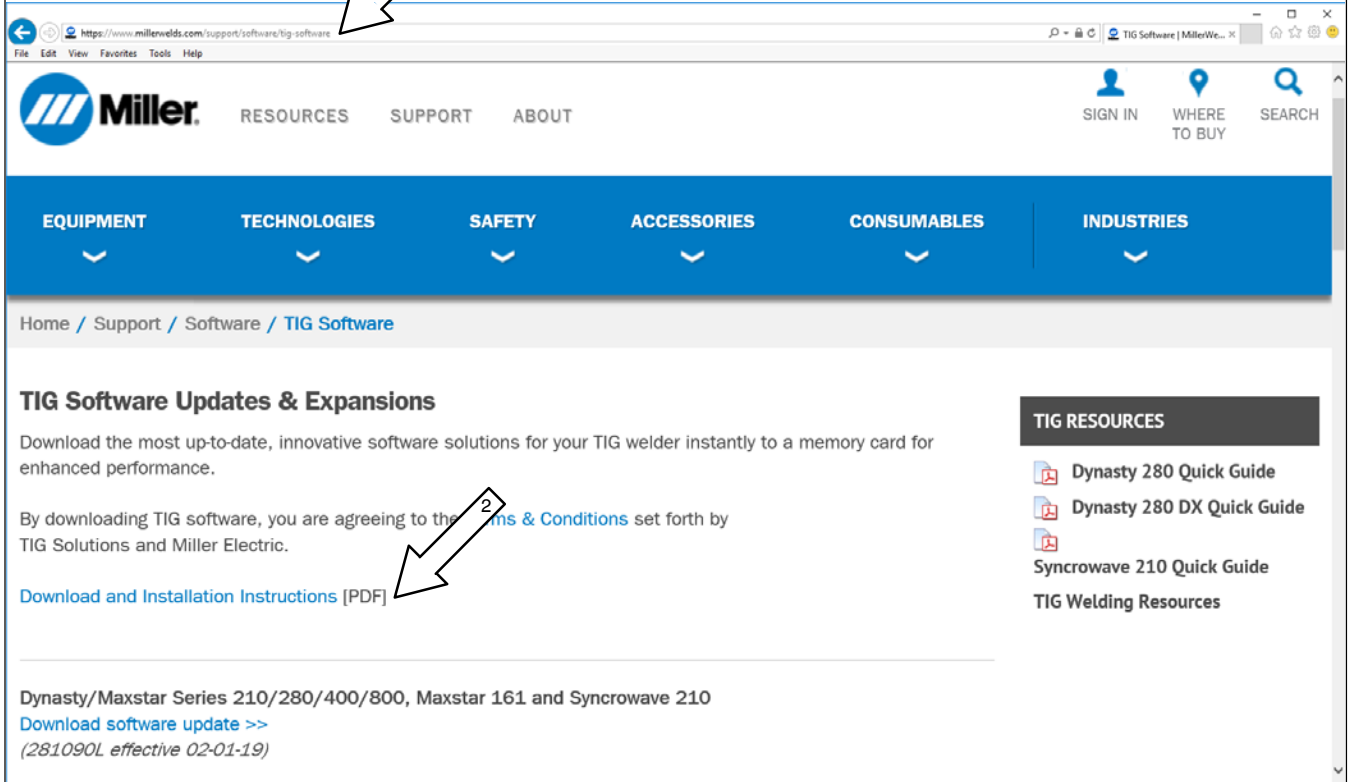

The screenshot shows the Miller website navigation menu with options: EQUIPMENT, TECHNOLOGIES, SAFETY, ACCESSORIES, CONSUMABLES, and INDUSTRIES. The breadcrumb trail is Home / Support / Software / TIG Software. The main heading is "TIG Software Updates & Expansions". Below the heading, it says "Download the most up-to-date, innovative software solutions for your TIG welder instantly to a memory card for enhanced performance." A paragraph follows: "By downloading TIG software, you are agreeing to the [Terms & Conditions](#) set forth by TIG Solutions and Miller Electric." A link "Download and Installation Instructions [PDF]" is highlighted with an arrow labeled 2. On the right, there is a "TIG RESOURCES" section with links to "Dynasty 280 Quick Guide", "Dynasty 280 DX Quick Guide", and "Syncrowave 210 Quick Guide". At the bottom, it lists "Dynasty/Maxstar Series 210/280/400/800, Maxstar 161 and Syncrowave 210" and provides a "Download software update >>" link with the note "(281090L effective 02-01-19)".

SECTION 6 – SYNCROWAVE OPERATION

6-1. Syncrowave Controls

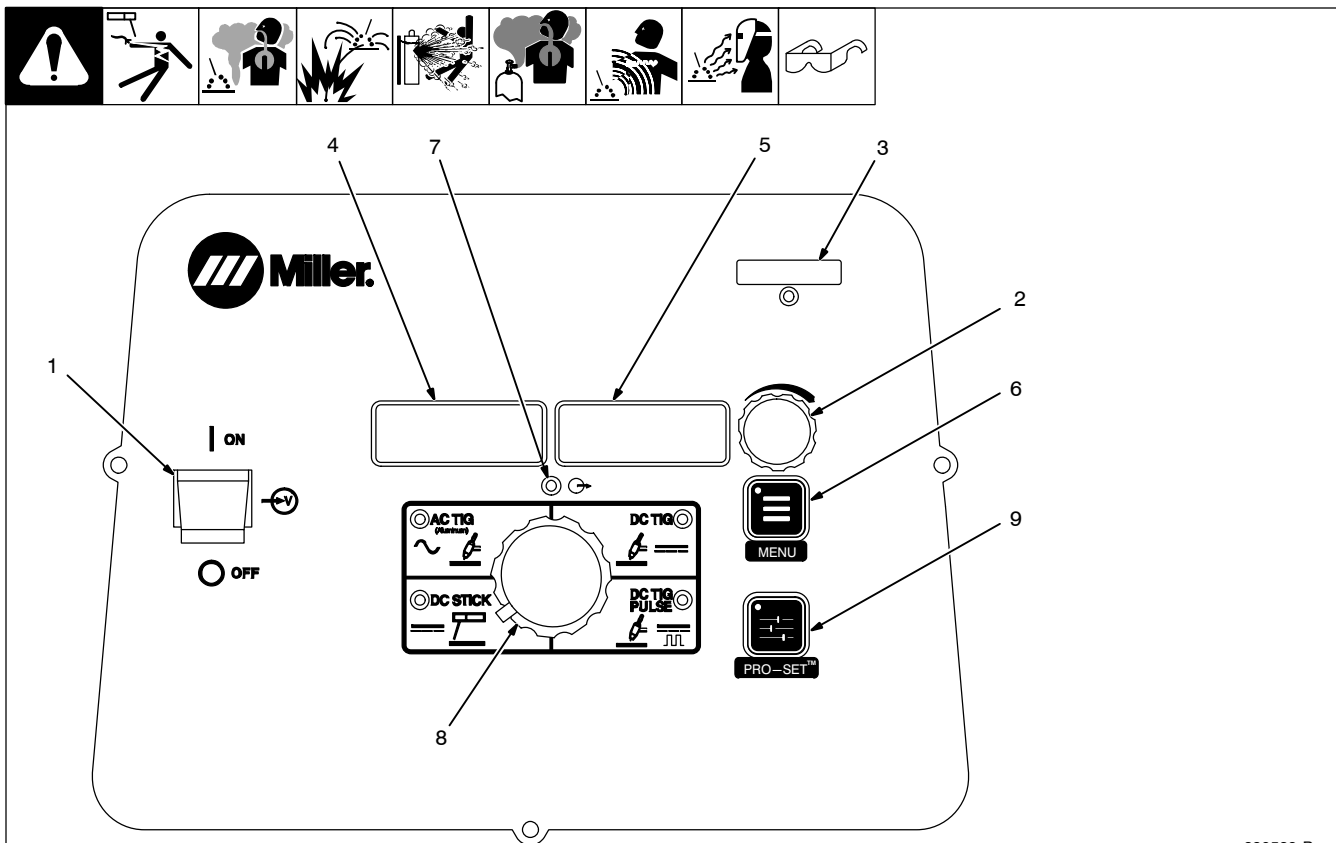

280539-B

1 Main Power Switch

Use switch to turn machine on or off.

2 Amperage Adjustment Control

Use control to change preset amperage value. If a remote control is used, preset amperage value is the maximum amperage output available. This control also functions as a parameter change control while in the menu mode (see Sections 6-2 thru 7-1).

3 Memory Card Port And Indicator

This port is used to add features to the machine and update software to the boards within the machine. Indicator is lit while card is being accessed (see Section 5-10D.).

4 Volt Meter

Displays actual rectified average voltage when voltage is present at the weld output terminals. It is also used to display parameter descriptions while in the menu.

5 Ammeter

Displays actual amperage while welding and preset amperage while idle. It is also used to display parameter selection options while in the menu.

6 Menu Button

Press button to scroll through available parameters for the selected process. Hold button to enter set-up mode (see Sections 6-2 thru 7-1).

7 Output ON Indicator

Blue indicator illuminates when output is on.

8 Process Selector

Use to select one of the following processes:

- AC TIG - Used for welding aluminum.
- DC TIG - (DCEN) Used for welding mild and stainless steel.
- DC Stick - (DCEP) Used for welding steels.
- DC TIG PULSE - (DCEN) Used for welding mild and stainless steel.

9 Pro Set Button

Press button to lock in all parameters to factory setting while LED is lit. Press and Hold for 5 seconds to reset all parameters to factory settings. Meter display counts down.



The memory card port uses an SD memory card. The SD logo is a registered trademark of SD-3C LLC.

6-2. Accessing Process Menu: AC TIG

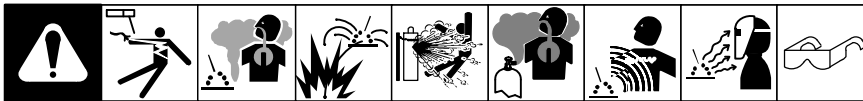

- 1 Menu Button
 - 2 Parameter Display
 - 3 Setting Display
 - 4 Encoder
- Rotate Encoder to adjust parameter setting.

Parameter automatically returns to amperage setting 15 seconds after Encoder is inactive.

Amperage Control:

Controls the welding amperage output. Limits the maximum output of a remote amperage device.

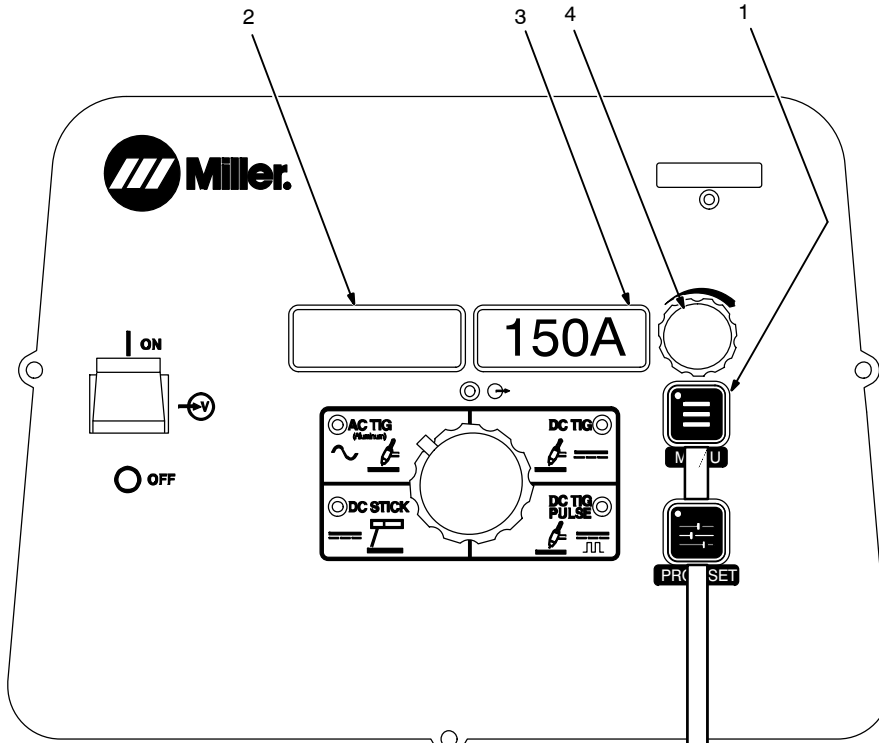

280539-B

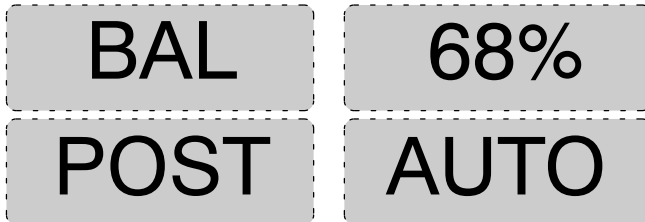

[BAL] Balance Control:* (% EN)

Controls Oxide Cleaning

Increasing setting reduces oxide cleaning. Range is Ball, 60 to 80%. (See tips below)

"Ball" sets the Balance to 30%. This allows the operator to form a ball on the tip of the tungsten. "Ball" is not intended for normal welding operation.

[POST] Post Flow Control:

Controls the length of time gas flows after welding stops. Range is AUTO, OFF - 50T (seconds). AUTO calculates the time based on the maximum amperage of each welding cycle. The minimum time is 8 seconds. Auto = maximum amperage/10.

***PRO-SET** provides PROfessionally developed SETtings for the weld process. To use PRO-SET, press the menu button to display the parameter and adjust the encoder until PRO-SET flashes on the display. PRO-SET flashes one time and reveals the professional setting for the parameter.

TIP: AC Balance controls the cleaning action. If floating black spots appear in the puddle, the balance setting is too high. Turn the balance down until puddle becomes clear.

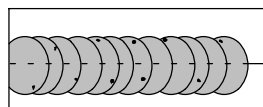
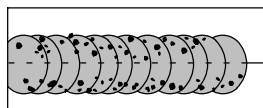

6-3. Accessing Process Menu: DC TIG And DC TIG Pulse

1 Menu Button
Press Menu button to cycle through parameters that can be set.

2 Parameter Display
3 Setting Display
4 Encoder
Rotate Encoder to adjust parameter setting.

Parameter automatically returns to amperage setting 15 seconds after Encoder is inactive.

Amperage Control:
Controls the welding amperage output. Limits the maximum output of a remote amperage device.

[PPS]* Pulse Control (DC TIG Pulse Only):
Reduces heat input to minimize distortion and increase travel speed. Set PPS (pulses per second). The range is 0.1-150 PPS. The Background Amperage and Peak Amperage are not adjustable. Background Amperage equals 25% of Peak amperage. Peak amperage Time equals 40%.

[POST] Post Flow Control:
Controls the length of time gas flows after welding stops. Range is AUTO, OFF-50T (seconds). AUTO calculates the time based on the maximum amperage of each weld cycle. The minimum time is eight seconds. Auto = maximum amperage/10.

*PRO-SET: provides PROfessionally developed SETtings for the welding process. To use PRO-SET, press the menu button to display the parameter and adjust the encoder until PRO-SET flashes on the display. PRO-SET flashes one time and reveals the professional setting for the parameter.

280539-B

6-4. Accessing Process Menu: DC Stick

1 Menu Button
Press Menu button to cycle through parameters that can be set.

2 Parameter Display
3 Setting Display
4 Encoder
Rotate Encoder to adjust parameter setting.

Parameter automatically returns to amperage setting 15 seconds after Encoder is inactive.

Amperage Control:
Controls the welding amperage output. Limits the maximum output of a remote amperage device.

[DIG]* Arc Force Control:
Controls the amount of additional amperage at low voltage (short arc length) conditions. Adjust the force of the arc for different joint configurations and electrodes. Range is OFF-100%. Features PRO-SET values for 6010 [65%] and 7018 [30%] electrodes.

*PRO-SET provides PROfessionally developed SETtings for the weld process. To use PRO-SET, press the menu button to display the parameter and adjust the encoder until PRO-SET flashes on the display. PRO-SET flashes one time and reveals the professional setting for the parameter.

280539-B

6-5. Accessing User Menu: AC/DC TIG And DC TIG Pulse

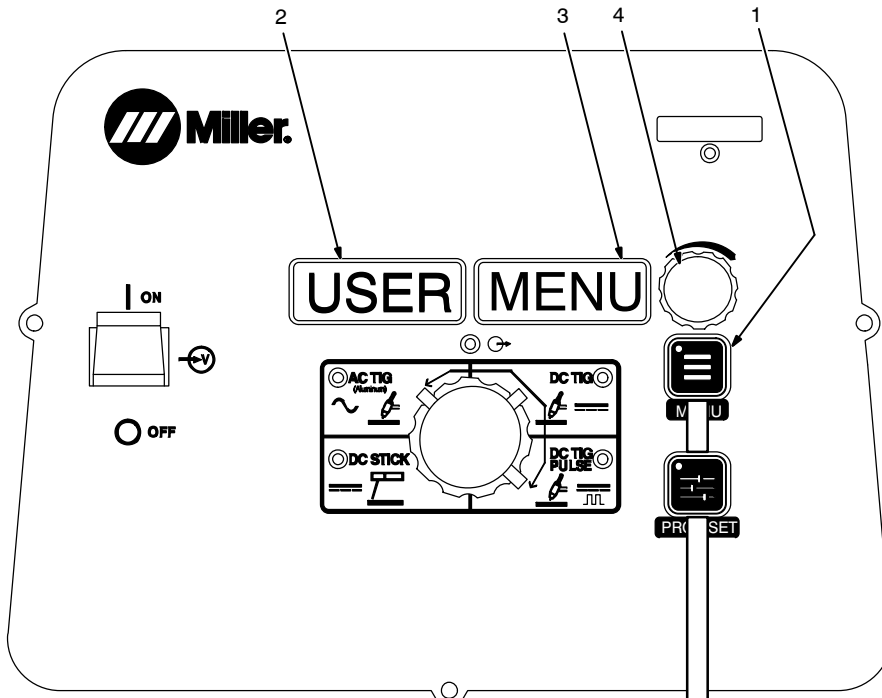
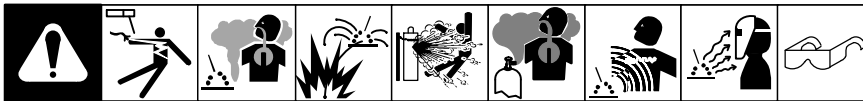

- 1 Menu Button
Press and hold Menu button for approximately two seconds until USER MENU appears to access machine configuration menus. Press Menu button to cycle through parameters that can be set.
 - 2 Parameter Display
 - 3 Setting Display
 - 4 Encoder
Rotate Encoder to adjust parameter setting.
- To exit menu, press and hold Menu button until Menu Off is displayed.

280539-B

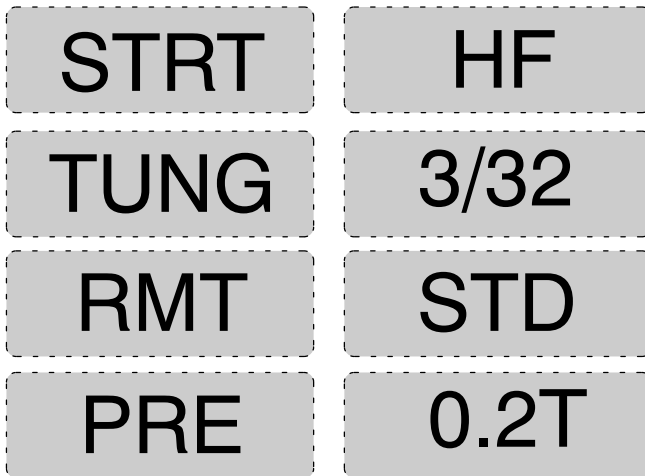

Arc Starting Method Selection:

[STRT] [HF]

High Frequency is a non-contact starting method. (see Section 13-1)

[STRT] [LIFT]

Lift Arc is a contact starting method. (see Section 13-1)

Tungsten Diameter Selection:

Each tungsten size has preset starting parameters specific to that diameter for optimized starting. Range is 0.040 in.–1/8 in. or 1.0 mm–3.2 mm.

Trigger Mode Selection:

[RMT] [STD]

Typically used with a remote foot or hand control. RMT STD requires a maintained contact closure to enable weld output. Amperage can be controlled with a remote potentiometer, or it can be set at the control panel.

[RMT] [HOLD]

Remote control required. Allows the operator to weld without holding the trigger closed. To start the weld, operator presses and releases trigger. To stop the weld, the operator again presses and releases the trigger. In this mode, only the output contactor is controlled by the remote control. Amperage must be set on the control panel.

[OUT] [ON]

Output on. (Lift Only)

⚠ Weld output terminals are energized at all times when displays read [OUT] [ON].

No remote control or trigger required. Amperage can be controlled at the control panel or with a remote potentiometer. Blue output on LED illuminates to indicate output is on.

[PRE] Preflow Time:

Controls length of time gas flows prior to arc start. Range is OFF-25T (seconds).

6-6. Accessing User Menu: DC Stick

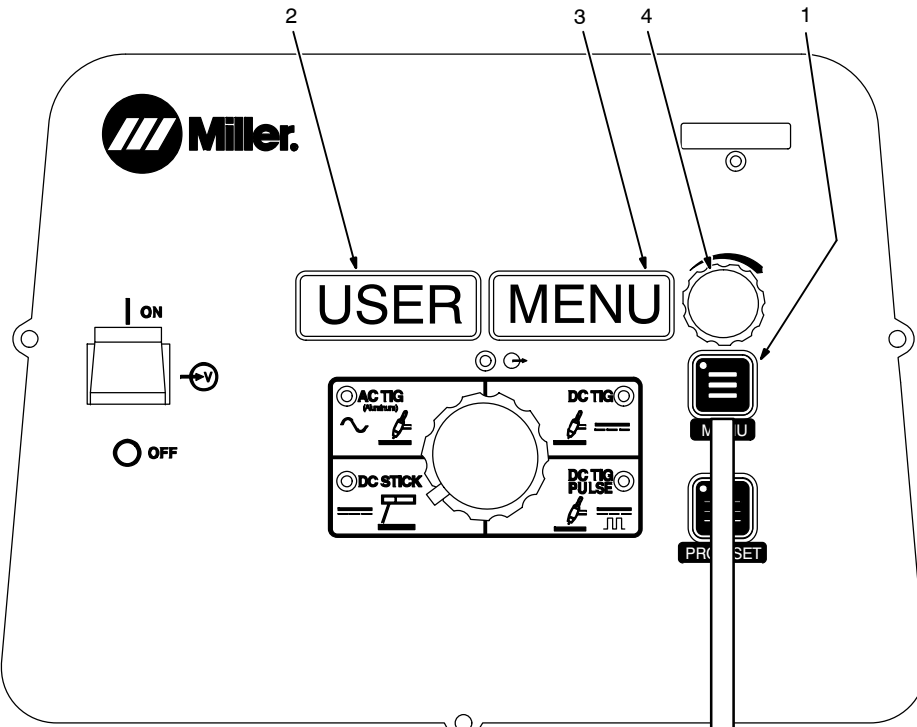
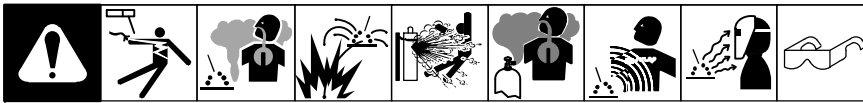

1 Menu Button
Press and hold Menu button for approximately 2 seconds to access machine configuration menus. Use Menu button to cycle through parameters that can be set.

2 Parameter Display

3 Setting Display

4 Encoder

Rotate Encoder to adjust parameter setting.

To exit menu, press and hold Menu button until Menu Off is displayed.



Trigger Mode Selection:

[RMT] [STD]

Typically used with a remote foot or hand control. RMT STD requires a maintained contact closure to enable weld output. Amperage can be controlled with a remote potentiometer, or it can be set at the control panel.

[OUT] [ON]

Warning: Weld output terminals are energized at all times when displays read [OUT] [ON].

No remote control or trigger required. Amperage can be controlled at the control panel or with a remote potentiometer. Blue output on LED illuminates to indicate output is on.

280539-B

SECTION 7 – ADVANCED MENU FUNCTIONS

7-1. Accessing Tech Menu

1 Menu Button
Press and hold Menu button for approximately four seconds to scroll past User Menu to Tech Menu. Use Menu button to cycle through parameters that can be set.

2 Parameter Display
3 Setting Display
4 Encoder
Rotate Encoder to adjust parameter setting.

To exit tech menu, press and hold menu button approximately one second, or turn power off.

Settings in the Tech Menu are global, meaning they may pertain to all or some of the process.

280539-B

ARC	T/CY
ERR	LOG
COOL	AUTO
MACH	RSET
SOFT	WARE
SERL	NUM

[ARC] [T/CY] Arc Timer: Monitors hours, minutes, and cycles of valid arc on. To view, rotate encoder. To reset, rotate encoder until [RESET] [YES] is displayed. Press Menu button to display [RESET] [Done]. Displays turn to [000] [000].

[ERR] [LOG] Error Log: Use to view last eight logged error events. Each event may list multiple Error Codes. See Section 8-3.

[COOL] Cooler Power (if cooler equipped): Selects between [OFF], [ON], and [AUTO]. [OFF] disables the power to the cooler. [ON] enables the power to the cooler whenever power source is turned on. [AUTO] provides power to the cooler when the TIG process is active.

[MACH] [RESET] Machine Reset: Resets all machine values back to factory defaults. To reset, turn encoder to [RESET] [YES]. Then press Menu button. [RESET] [DONE] will be displayed when the reset is complete and factory defaults have been restored.

[SOFT] [WARE] Software Number: Software number and revision will be displayed.

[SERL] [NUM] Serial Number: If serial number displayed does not match serial number of machine, see Section 8-3.

7-2. Summary Of Default And Pro-Set Parameters

	AC TIG		DC TIG		DC PULSE TIG		STICK	
Process Menu	Range	Default (Pro-Set)	Range	Default (Pro-Set)	Range	Default (Pro-Set)	Range	Default (Pro-Set)
Balance	Ball 30%, 60% to 80%	68%	-	-	-	-	-	-
Pulses Per Second	-	-	-	-	.1 to 150 PPS	100 PPS	-	-
Post Flow	Auto, Off, On 1 to 50 Seconds	Auto	Auto, Off, On 1 to 50 Seconds	Auto	Auto, Off, On 1 to 50 Seconds	Auto	-	-
Dig Control	-	-	-	-	-	-	Off to 100%	30%
User Menu								
	Range	Default	Range	Default	Range	Default	Range	Default
Start Method	HF, Lift	HF	HF, Lift	HF	HF, Lift	HF	-	-
Tungsten Size	0.40 to 1/8	3/32	0.40 to 1/8	3/32	0.40 to 1/8	3/32	-	-
Trigger Mode	Hold, On*, Standard	Standard	Hold, On*, Standard	Standard	Hold, On*, Standard	Standard	On, Standard	Standard
Pre Flow	Off, 0.2 to 25 Seconds	0.2 Seconds	Off, 0.2 to 25 Seconds	0.2 Seconds	Off, 0.2 to 25 Seconds	0.2 Seconds	-	-
Tech Menu								
	Range	Default	Range	Default	Range	Default	Range	Default
Arc Timer	-	-	-	-	-	-	-	-
Error Log	-	-	-	-	-	-	-	-
Cooler Power	Auto, On, Off	Auto	Auto, On, Off	Auto	Auto, On, Off	Auto	Auto, On, Off	Auto
Factory Reset	-	-	-	-	-	-	-	-
Software Number	-	-	-	-	-	-	-	-
Serial Number	-	-	-	-	-	-	-	-

* "On" Trigger Mode only available in Lift Arc Start Method.

7-3. Output Control And Trigger Functions

E. Remote (Standard), 2T, Torch Trigger Operation

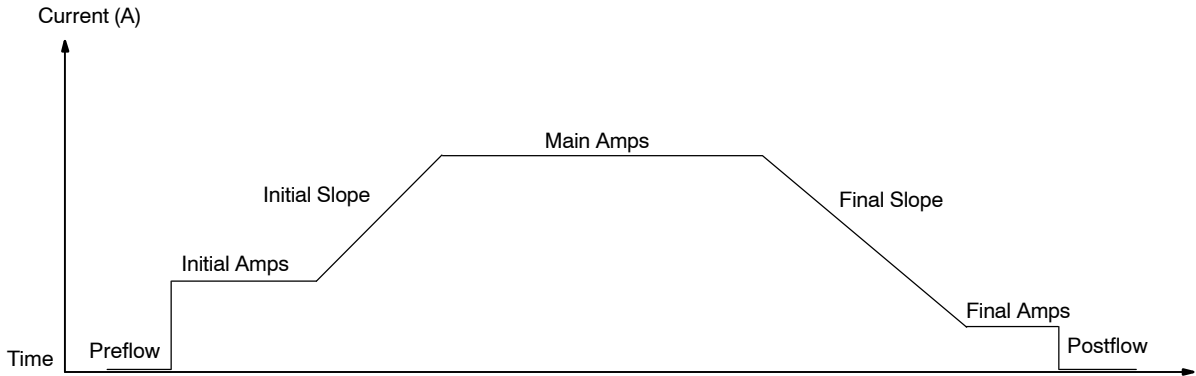
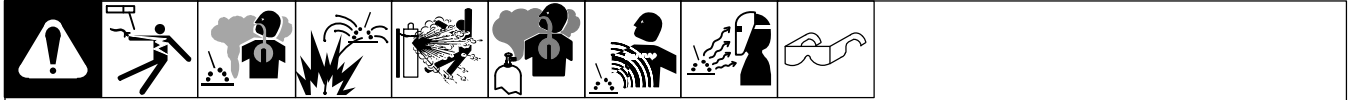

Standard

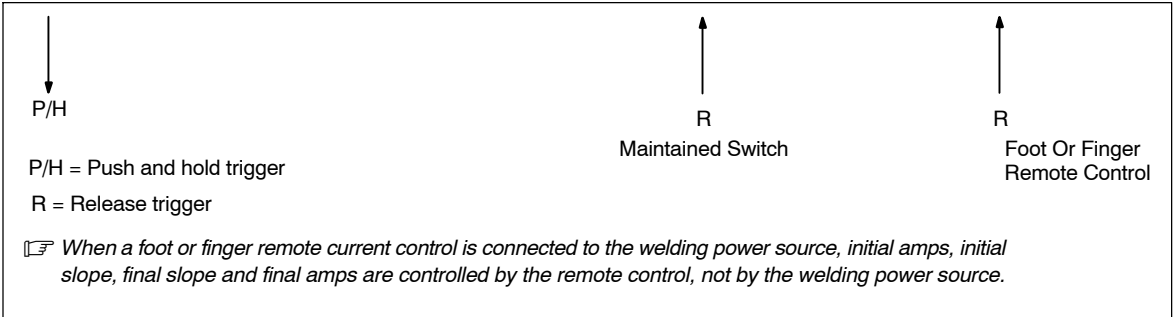



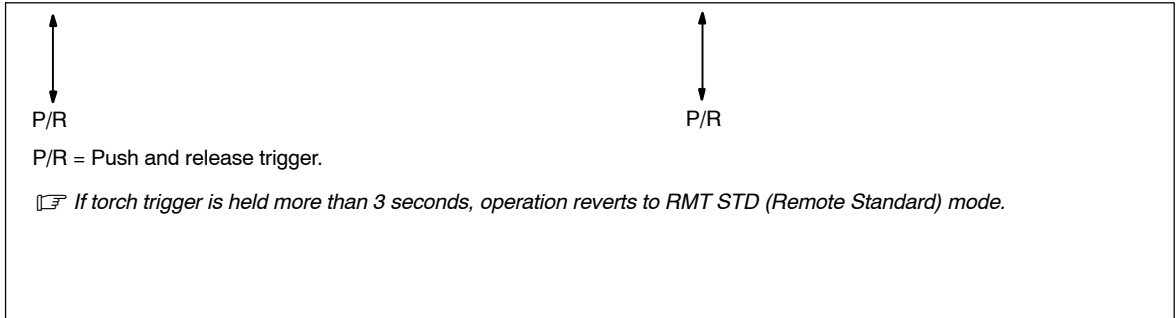

Remote 2T







SECTION 8 – MAINTENANCE AND TROUBLESHOOTING



8-1. Routine Maintenance

				<p>⚠ Disconnect power before maintaining.</p> <p> <i>Maintain more often during severe conditions.</i></p>
---	---	---	---	---

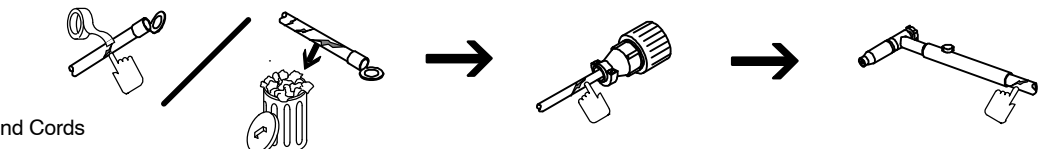
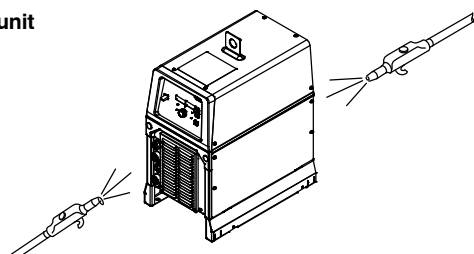
A. Welding Power Source

		✓ = Check * To be done by Factory Authorized Service Agent	◇ = Change	● = Clean	Δ = Repair	☆ = Replace
Every 3 Months						
Every 3 Months						
Every 6 Months	<p>⚠ Do not remove case when blowing out inside of unit</p>  <p>●: During heavy service, clean monthly.</p>					

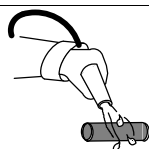
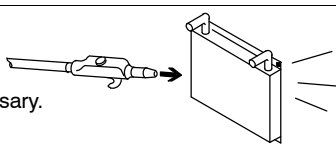
B. Optional Cooler

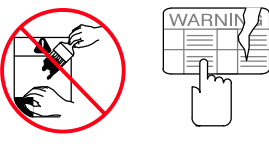
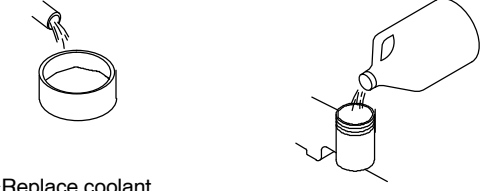
		✓ = Check * To be done by Factory Authorized Service Agent	◇ = Change	● = Clean	Δ = Repair	☆ = Replace
Every 3 Months		<p>● Coolant Strainer, during heavy service, clean more frequently.</p>				
Every 6 Months						
Every 12 Months	 <p>◇ Replace coolant.</p>					

8-2. Voltmeter/Ammeter Display Messages

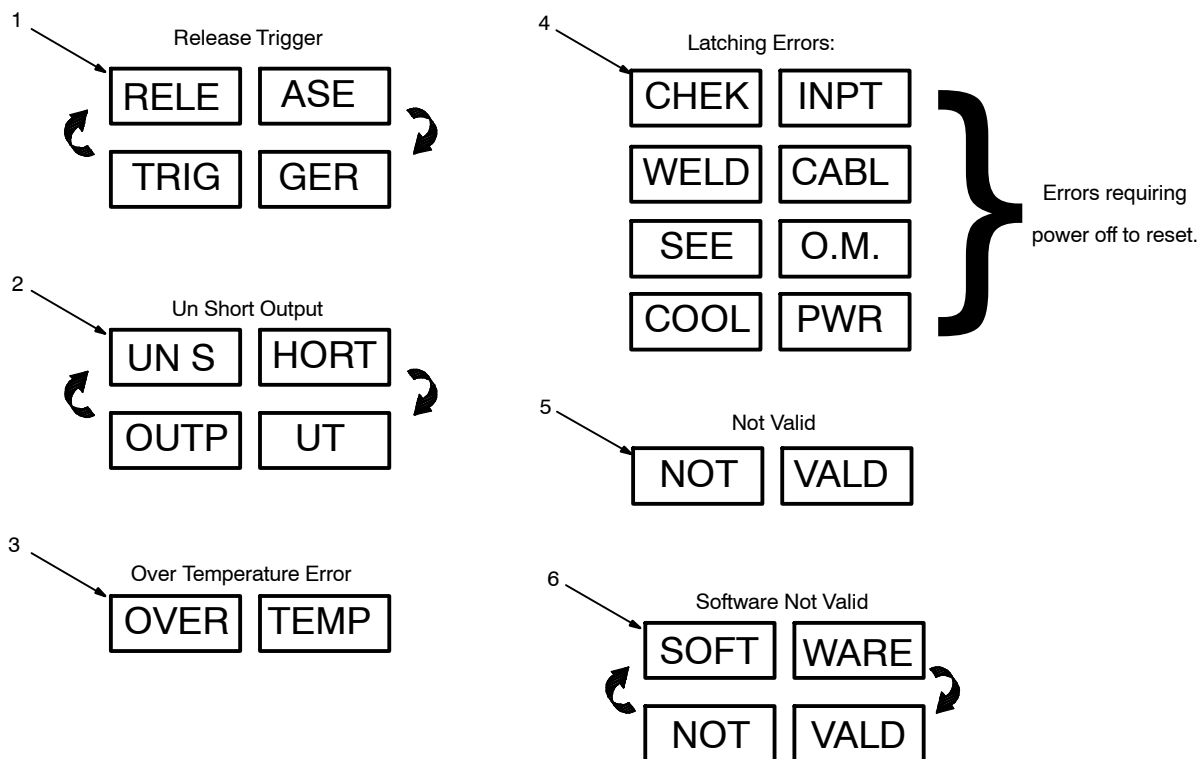

☞ All directions are in reference to the front of the unit. All circuitry referred to is located inside the unit.

1 [RELE] [ASE] / [TRIG] [GER]

Remote 14 receptacle contactor control (Pins A-B) must be opened before proceeding.

2 [UN S] [HORT] / [OUTP] [UT]

Short on weld output connections must be removed before proceeding. See Section 8-3 if display shows after weld output connections have been verified as not having a short.

3 [OVER] [TEMP]

Over temperature condition has occurred. Error will clear after temperatures reach acceptable levels.

4 Power down required to reset errors:

To clear error, turn off power. Wait until fan stops turning to power on again. See Section 8-3 if error does not clear or happens frequently.

[CHEK] [INPT] Check Input

High or low voltage has been sensed. Have a qualified person check input voltage.

[WELD] [CABL] Weld Cable

An error related to the weld cables has been sensed. Straighten out or shorten weld cables. If carbon arc gouging, adjust DIG setting to CARBON ARC. See Section 6-4

[SEE] [O.M.] See Owner's Manual: See Section 8-3.

[COOL] [PWR] Cooler Power

An error related to the power supplied to the cooler, incorrect primary wiring on single phase, or a blown fuse has occurred. When error will not clear or occurs frequently, machine can be used without the cooler. Turn Cooler Power off (see Section 7-1).

5 [NOT] [VALD]

Message is displayed when attempting an incompatible setup.

6 [SOFT] [WARE] [NOT] [VALD]

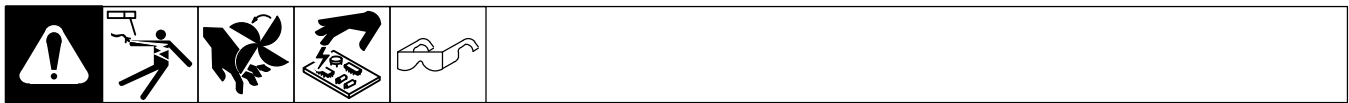

A software compatibility error has been detected. A software update is required (see Section 5-10 Software Updates). See Section 8-3 if display shows after a software update is performed.

8-3. Troubleshooting Table



Trouble	Remedy
No weld output; unit completely inoperative.	Place line disconnect switch in On position (see Section 5-7 or 5-8).
	Check and replace line fuse(s), if necessary, or reset circuit breaker (see Section 5-7 or 5-8).
	Check for proper input power connections (see Section 5-7 or 5-8).
No weld output; meter display On.	If using remote control, be sure correct process is enabled to provide output control at Remote 14 receptacle (see Section 5-9 as applicable).
	Input voltage outside acceptable range of variation (see Section 5-6).
	Check, repair, or replace remote control.
	Unit overheated. Allow unit to cool with fan On (see Section 4-6).
Erratic or improper weld output.	Use proper size and type of weld cable (see Section 5-3).
	Clean and tighten all weld connections (see Section 8-1).
Fan not operating.	Check for and remove anything blocking fan movement.
	Have Factory Authorized Service Agent check fan motor.
Wandering arc.	Use proper size tungsten (see Section 12).
	Use properly prepared tungsten (see Section 12).
	Reduce gas flow rate.
Tungsten electrode oxidizing and not remaining bright after conclusion of weld.	Shield weld zone from drafts.
	Increase postflow time.
	Check and tighten all gas fittings (see Section 8-1A.).
	Water in torch. Refer to torch manual.
Blank Display.	Verify Power to machine.
	A software update may be required (see Section 5-10, Software Updates). Contact factory if display remains blank after a software update is performed.
Error message [ERR] [LOG] is displayed.	Contact a Factory Authorized Service Agent for an explanation of the error code.
Latching Errors see Section 8-2.	Contact a Factory Authorized Service Agent if error does not clear or happens frequently.
Error message [SEE] [O.M.] is displayed.	Contact a Factory Authorized Service Agent.
Tech Menu (See Section 7) [SERL][NUM] is selected, and serial number displayed does not match serial number of machine.	Contact a Factory Authorized Service Agent.
Error message [UN S] [HORT] / [OUTP] [UT] is displayed.	Contact a Factory Authorized Service Agent if display shows after weld output connections have been verified as not having a short.
Error message [SOFT] [WARE] [NOT] [VALD] is displayed.	Contact a Factory Authorized Service Agent if display shows after a software update is performed.

8-4. Blowing Out Inside of Unit



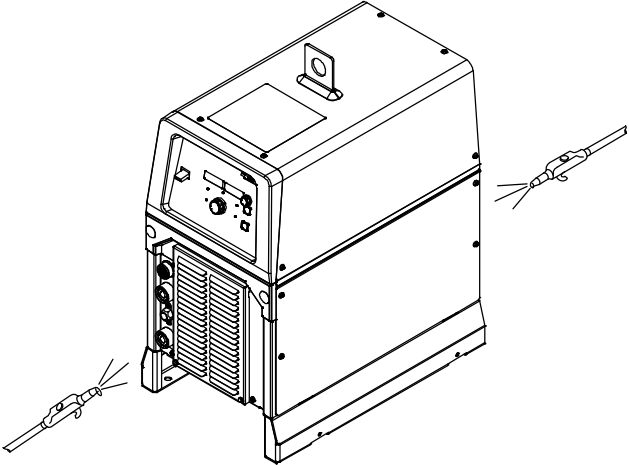



⚠ Do not remove case when blowing out inside of unit.

To blow out unit, direct airflow through front and back louvers as shown.

Ref 805617-A

8-5. Coolant Maintenance

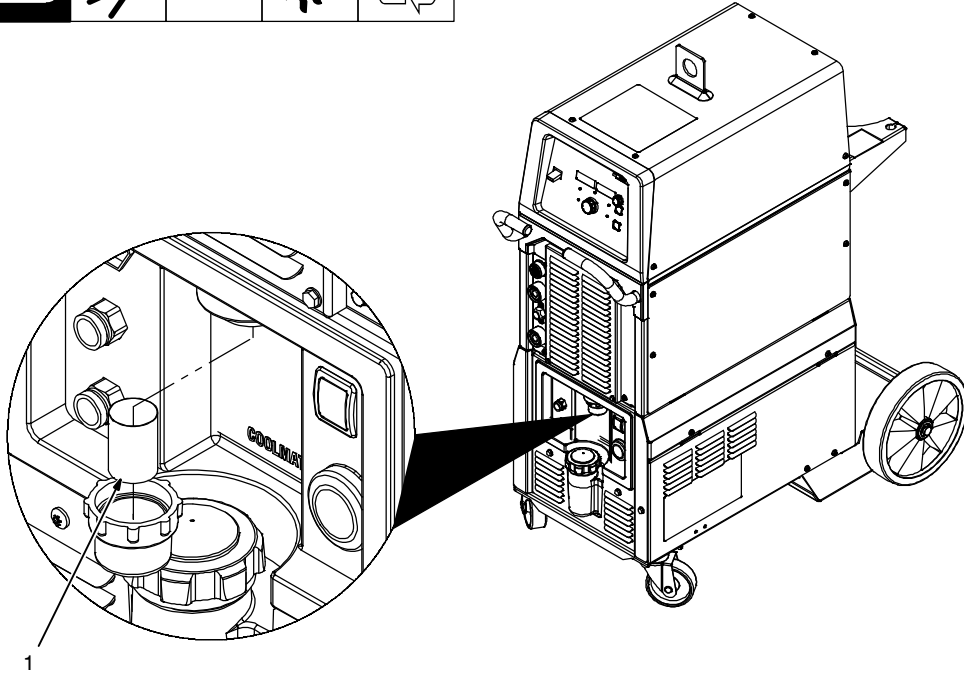

⚠ Disconnect input power before maintaining.

1 Coolant Filter

Unscrew housing to clean filter.

Changing coolant: Drain coolant by tipping unit to the front, or use suction pump. Fill with clean water and run for 10 minutes. Drain and refill with coolant.

☞ If replacing hoses, use hoses compatible with ethylene glycol, such as Buna-N, Neoprene, or Hypalon. Oxy-acetylene hoses are not compatible with any product containing ethylene glycol.

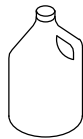
Application	GTAW Or Where HF* Is Used
 Coolant	Low Conductivity Coolant No. 043810**; Distilled Or Deionized Water OK Above 32° F (0° C)

*HF: High Frequency Current

**Coolant 043810, a 50/50 solution, protects to -37° F (-38° C) and resist algae growth.

NOTICE – Use of any coolant other than that listed in the table voids the warranty on any parts that come in contact with the coolant (pump, radiator, etc.).

805621-A

SECTION 10 – ELECTRICAL DIAGRAM

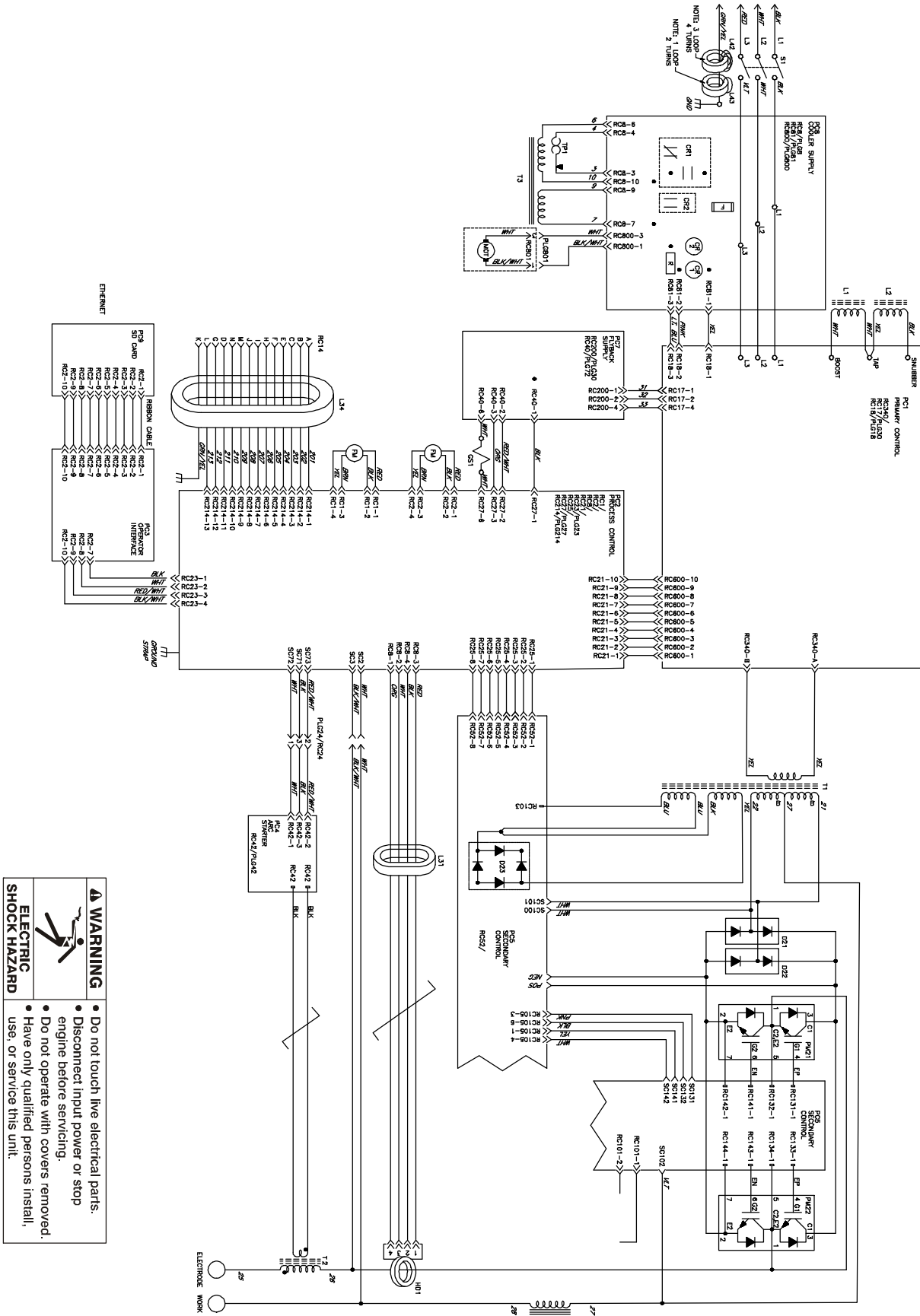

WARNING

ELECTRIC SHOCK HAZARD

- Do not touch live electrical parts.
- Disconnect input power or stop engine before servicing.
- Do not operate with covers removed.
- Have only qualified persons install, use, or service this unit.

Figure 10-1. Circuit Diagram

SECTION 11 – HIGH FREQUENCY

11-1. Welding Processes Requiring High Frequency



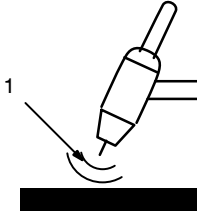

TIG

1 High-Frequency Voltage
TIG – helps arc jump air gap between torch and workpiece and/or stabilize the arc.

high_freq 2018-01

11-2. Installation Showing Possible Sources Of HF Interference



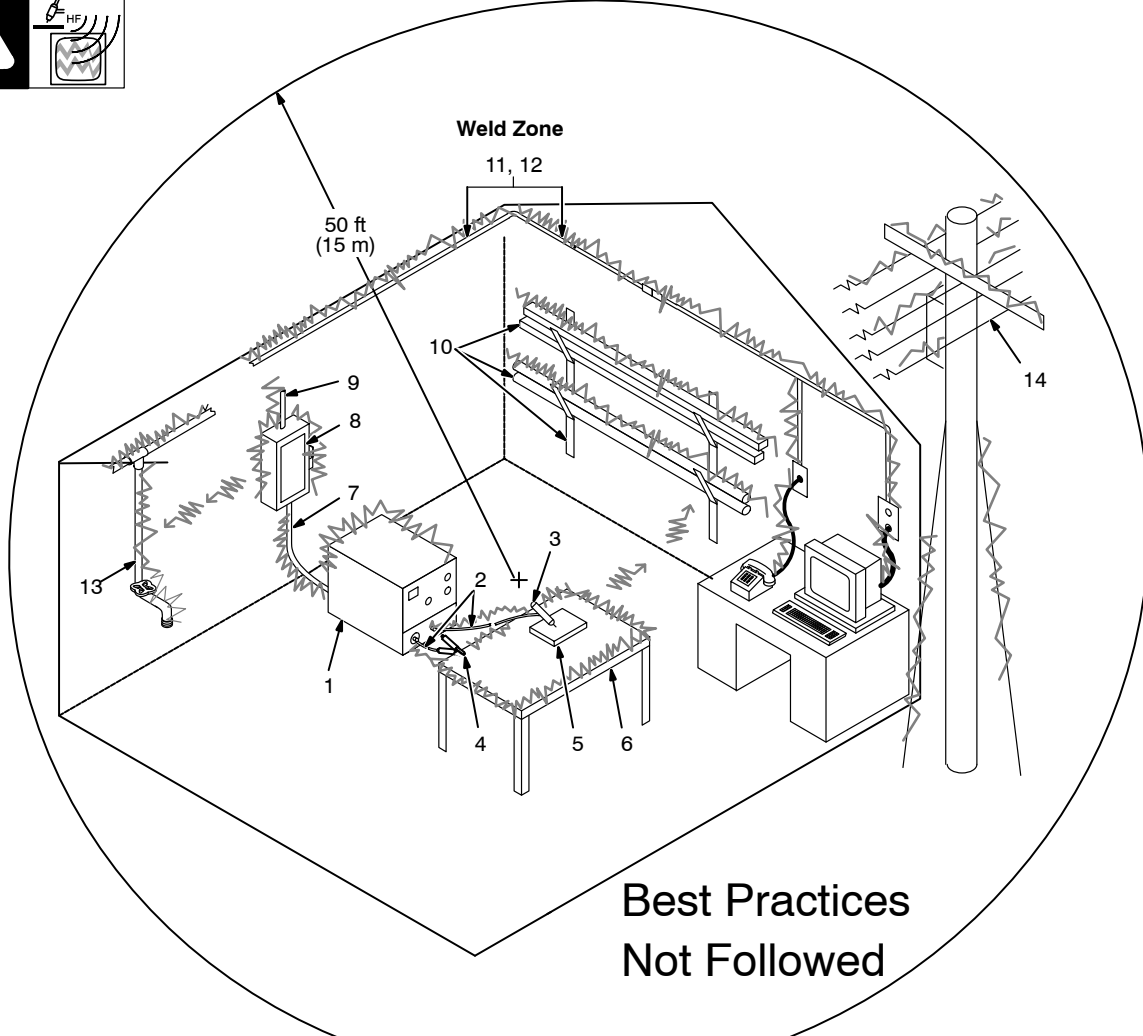

Best Practices
Not Followed

Sources of Direct High-Frequency Radiation	Sources of Conduction of High Frequency	Sources of Reradiation of High Frequency
1 High-Frequency Source (welding power source with built-in HF or separate HF unit)	7 Input Power Cable	10 Ungrounded Metal Objects
2 Weld Cables	8 Line Disconnect Device	11 Lighting
3 Torch	9 Input Supply Wiring	12 Wiring
4 Work Clamp		13 Water Pipes and Fixtures
5 Workpiece		14 External Phone and Power Lines
6 Work Table		

S-0694

11-3. Recommended Installation To Reduce HF Interference

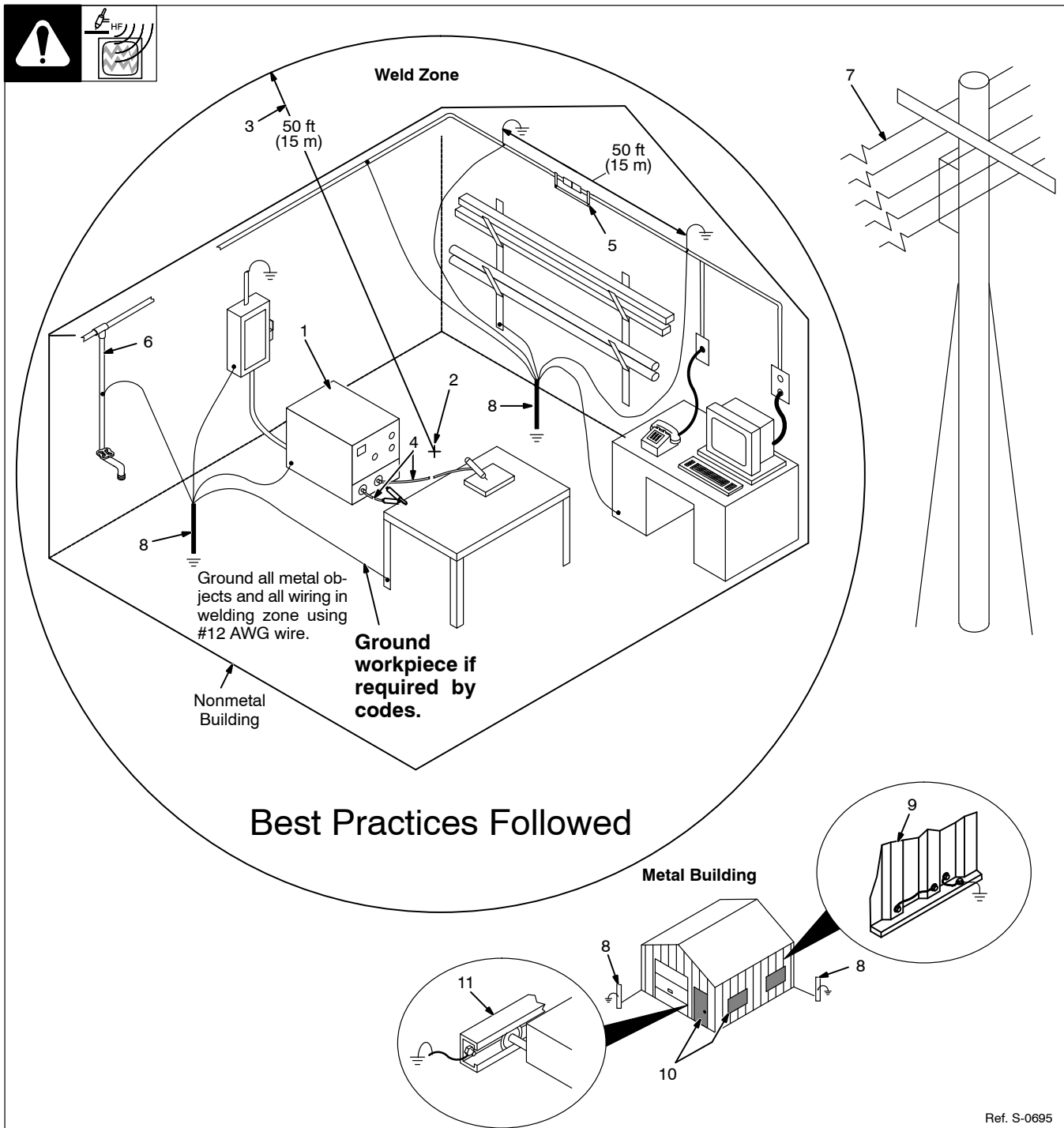

Best Practices Followed

- 1 High-Frequency Source (welding power source with built-in HF or separate HF unit)
Ground metal machine case (clean paint from around hole in case, and use case screw), work output terminal, line disconnect device, input supply, and worktable.
- 2 Center Point of Welding Zone
Midpoint between high-frequency source and welding torch.
- 3 Welding Zone
A circle 50 ft (15 m) from center point in all directions.
- 4 Weld Output Cables
Keep cables short and close together.

- 5 Conduit Joint Bonding and Grounding
Electrically join (bond) all conduit sections using copper straps or braided wire. Ground conduit every 50 ft (15 m).
- 6 Water Pipes and Fixtures
Ground water pipes every 50 ft (15 m).
- 7 External Power or Telephone Lines
Locate high-frequency source at least 50 ft (15 m) away from power and phone lines.
- 8 Grounding Rod
Consult the National Electrical Code for specifications.

- ### Metal Building Requirements
- 9 Metal Building Panel Bonding Methods
Bolt or weld building panels together, install copper straps or braided wire across seams, and ground frame.
 - 10 Windows and Doorways
Cover all windows and doorways with grounded copper screen of not more than 1/4 in (6.4 mm) mesh.
 - 11 Overhead Door Track
Ground the track.

Ref. S-0695

SECTION 12 – SELECTING AND PREPARING A TUNGSTEN FOR DC OR AC WELDING WITH INVERTER MACHINES

gtaw_Inverter_2018-01



Whenever possible and practical, use DC weld output instead of AC weld output.

12-1. Selecting Tungsten Electrode (Wear Clean Gloves To Prevent Contamination Of Tungsten)

A. Select Tungsten Electrode.

 Not all tungsten electrode manufacturers use the same colors to identify tungsten type. Contact the tungsten electrode manufacturer or reference the product packaging to identify the tungsten you are using.

Electrode Diameter	Amperage Range - Gas Type♦ - Polarity	
	(DCEN) – Argon Direct Current Electrode Negative (For Use With Mild Or Stainless Steel)	AC – Argon Unbalanced Wave (For Use With Aluminum)
2% Ceriated, 1.5% Lanthanum, Or 2% Thorium Alloy Tungstens		
.010 in. (.25 mm)	Up to 15	Up to 15
.020 in. (.50 mm)	5-20	5-20
.040 in. (1 mm)	15-80	15-80
1/16 in. (1.6 mm)	70-150	70-150
3/32 in. (2.4 mm)	150-250	140-235
1/8 in. (3.2 mm)	250-400	225-325
5/32 in. (4.0 mm)	400-500	300-400
3/16 in (4.8 mm)	500-750	400-500
1/4 in. (6.4 mm)	750-1000	500-630

♦ Typical argon shielding gas flow rates are 10 to 25 CFH (cubic feet per hour).

Figures listed are a guide and are a composite of recommendations from American Welding Society (AWS).

B. Electrode Composition.

Tungsten Type	Application Notes
2% Cerium (Grey*)	Good all-around tungsten for both AC and DC welding.
1.5–2% Lanthanum (Yellow/Blue)	Excellent low amp starts for AC and DC welding.
2% Thorium (Red)	Commonly used for DC welding, not ideal for AC.
Pure Tungsten (Green)	Not Recommended for inverters! For best results in most applications use a sharpened cerium or lanthanum electrode for AC and DC welding.

* Color may vary depending on manufacturer, please refer to manufacturer's guide for color designation.

SECTION 13 – TIG PROCEDURES

gtaw_Inverter_2011-06

For additional resources on welding, visit <http://www.millerwelds.com/resources/welding-resources/>

13-1. Lift-Arc And HF TIG Start Procedures

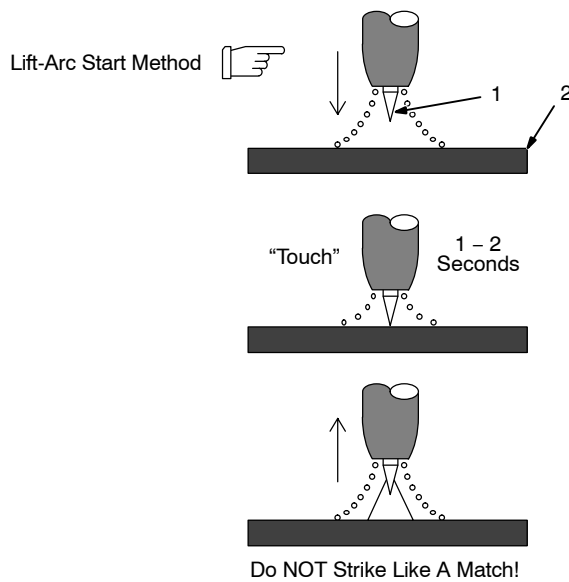
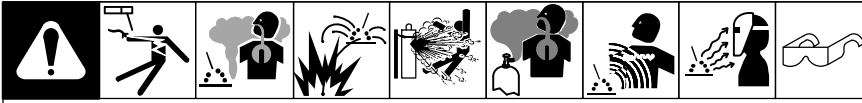

Lift-Arc Start

When Lift-Arc™ button light is On, start arc as follows:

- 1 TIG Electrode
- 2 Workpiece

Touch tungsten electrode to workpiece at weld start point, enable output and shielding gas with torch trigger, foot control, or hand control. **Hold electrode to workpiece for 1-2 seconds**, and slowly lift electrode. Arc is formed when electrode is lifted.

Normal open-circuit voltage is not present before tungsten electrode touches workpiece; only a low sensing voltage is present between electrode and workpiece. The solid-state output contactor does not energize until after electrode is touching workpiece. This allows electrode to touch workpiece without overheating, sticking, or getting contaminated.

Application:

Lift-Arc is used for the DCEN or AC GTAW process when HF Start method is not permitted, or to replace the scratch method.

HF Start

When HF Start button light is On, start arc as follows:

High frequency turns on to help start arc when output is enabled. High frequency turns off when arc is started, and turns on whenever arc is broken to help restart arc.

Application:

HF start is used for the DCEN GTAW process when a non-contact arc starting method is required.

SECTION 14 – STICK WELDING (SMAW) ELECTRODE AND AMPERAGE SELECTION CHART

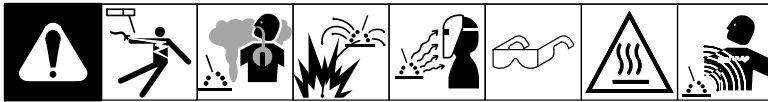

ELECTRODE	DIAMETER	AMPERAGE RANGE									
		50	100	150	200	250	300	350	400	450	
6010 & 6011	3/32	■									
	1/8		■								
	5/32			■							
	3/16				■						
	7/32					■					
6013	1/4					■					
	1/16	■									
	5/64		■								
	3/32			■							
	1/8				■						
	5/32					■					
	3/16						■				
	7/32							■			
	1/4								■		
	3/32									■	
7014	1/8										
	5/32										
	3/16										
	7/32										
	1/4										
7018	3/32										
	1/8										
	5/32										
	3/16										
	7/32										
7024	1/4										
	3/32										
	1/8										
	5/32										
	3/16										
Ni-CI	7/32										
	1/4										
	3/32										
	1/8										
	5/32										
308L	3/16										
	7/32										
	1/4										

ELECTRODE	DC*	AC	POSITION	PENETRATION	USAGE
6010	EP		ALL	DEEP	MIN. PREP, ROUGH HIGH SPATTER
6011	EP	✓	ALL	DEEP	
6013	EP,EN	✓	ALL	LOW	GENERAL
7014	EP,EN	✓	ALL	MED	SMOOTH, EASY, FAST
7018	EP	✓	ALL	MED	LOW HYDROGEN, STRONG
7024	EP,EN	✓	FLAT HORIZ*	LOW	SMOOTH, EASY, FASTER
NI-CL	EP	✓	ALL	LOW	CAST IRON
308L	EP	✓	ALL	LOW	STAINLESS

*EP = ELECTRODE POSITIVE (REVERSE POLARITY)
EN = ELECTRODE NEGATIVE (STRAIGHT POLARITY)

Ref. S-087985-A

TRUE BLUE[®]

WARRANTY

Effective January 1, 2019

(Equipment with a serial number preface of MK or newer)

This limited warranty supersedes all previous Miller warranties and is exclusive with no other guarantees or warranties expressed or implied.

LIMITED WARRANTY – Subject to the terms and conditions below, Miller Electric Mfg. LLC, Appleton, Wisconsin, warrants to authorized distributors that new Miller equipment sold after the effective date of this limited warranty is free of defects in material and workmanship at the time it is shipped by Miller. THIS WARRANTY IS EXPRESSLY IN LIEU OF ALL OTHER WARRANTIES, EXPRESS OR IMPLIED, INCLUDING THE WARRANTIES OF MERCHANTABILITY AND FITNESS.

Within the warranty periods listed below, Miller will repair or replace any warranted parts or components that fail due to such defects in material or workmanship. Miller must be notified in writing within thirty (30) days of such defect or failure, at which time Miller will provide instructions on the warranty claim procedures to be followed. Notifications submitted as online warranty claims must provide detailed descriptions of the fault and troubleshooting steps taken to diagnose failed parts. Warranty claims that lack the required information as defined in the Miller Service Operation Guide (SOG) may be denied by Miller.

Miller shall honor warranty claims on warranted equipment listed below in the event of a defect within the warranty coverage time periods listed below. Warranty time periods start on the delivery date of the equipment to the end-user purchaser, or 12 months after the equipment is shipped to a North American distributor, or 18 months after the equipment is shipped to an international distributor, whichever occurs first.

1. 5 Years Parts — 3 Years Labor
 - * Original Main Power Rectifiers Only to Include SCRs, Diodes, and Discrete Rectifier Modules
2. 3 Years — Parts and Labor Unless Specified
 - * Auto-Darkening Helmet Lenses (No Labor) (See Classic Series Exception Below)
 - * Engine Driven Welder/Generators
(NOTE: Engines are Warranted Separately by the Engine Manufacturer.)
 - * Insight Welding Intelligence Products
 - * Inverter Power Sources
 - * Plasma Arc Cutting Power Sources
 - * Process Controllers
 - * Semi-Automatic and Automatic Wire Feeders
 - * Transformer/Rectifier Power Sources
3. 2 Years — Parts and Labor
 - * Auto-Darkening Helmet Lenses – Classic Series Only (No Labor)
 - * Auto-Darkening Weld Masks (No Labor)
 - * Fume Extractors – Capture 5, Filtair 400 and Industrial Collector Series
4. 1 Year — Parts and Labor Unless Specified
 - * AugmentedArc and LiveArc Welding Systems
 - * Automatic Motion Devices
 - * Bernard BTB Air-Cooled MIG Guns (No Labor)
 - * CoolBelt and CoolBand Blower Unit (No Labor)
 - * Desiccant Air Dryer System
 - * Field Options
(NOTE: Field options are covered for the remaining warranty period of the product they are installed in, or for a minimum of one year — whichever is greater.)
 - * RFCS Foot Controls (Except RFCS-RJ45)
 - * Fume Extractors – Filtair 130, MWX and SWX Series HF Units
 - * ICE/XT Plasma Cutting Torches (No Labor)
 - * Induction Heating Power Sources, Coolers
(NOTE: Digital Recorders are Warranted Separately by the Manufacturer.)
 - * Load Banks
 - * Motor-Driven Guns (except Spoolmate Spoolguns)
 - * PAPR Blower Unit (No Labor)
 - * Positioners and Controllers
 - * Racks (For Housing Multiple Power Sources)
 - * Running Gear/Trailers
 - * Spot Welders

- * Subarc Wire Drive Assemblies
 - * TIG Torches (No Labor)
 - * Tregaskiss Guns (No Labor)
 - * Water Cooling Systems
 - * Wireless Remote Foot/Hand Controls and Receivers
 - * Work Stations/Weld Tables (No Labor)
5. 6 Months — Parts
 - * Batteries
 6. 90 Days — Parts
 - * Accessories (Kits)
 - * Canvas Covers
 - * Induction Heating Coils and Blankets, Cables, and Non-Electronic Controls
 - * M-Guns
 - * MIG Guns, Subarc (SAW) Torches, and External Cladding Heads
 - * Remote Controls and RFCS-RJ45
 - * Replacement Parts (No labor)
 - * Spoolmate Spoolguns

Miller's True Blue[®] Limited Warranty shall not apply to:

1. **Consumable components; such as contact tips, cutting nozzles, contactors, brushes, relays, work station table tops and welding curtains, or parts that fail due to normal wear. (Exception: brushes and relays are covered on all engine-driven products.)**
2. Items furnished by Miller, but manufactured by others, such as engines or trade accessories. These items are covered by the manufacturer's warranty, if any.
3. Equipment that has been modified by any party other than Miller, or equipment that has been improperly installed, improperly operated or misused based upon industry standards, or equipment which has not had reasonable and necessary maintenance, or equipment which has been used for operation outside of the specifications for the equipment.
4. Defects caused by accident, unauthorized repair, or improper testing.

MILLER PRODUCTS ARE INTENDED FOR COMMERCIAL AND INDUSTRIAL USERS TRAINED AND EXPERIENCED IN THE USE AND MAINTENANCE OF WELDING EQUIPMENT.

The exclusive remedies for warranty claims are, at Miller's option, either: (1) repair; or (2) replacement; or, if approved in writing by Miller, (3) the pre-approved cost of repair or replacement at an authorized Miller service station; or (4) payment of or credit for the purchase price (less reasonable depreciation based upon use). Products may not be returned without Miller's written approval. Return shipment shall be at customer's risk and expense.

The above remedies are F.O.B. Appleton, WI, or Miller's authorized service facility. Transportation and freight are the customer's responsibility. TO THE EXTENT PERMITTED BY LAW, THE REMEDIES HEREIN ARE THE SOLE AND EXCLUSIVE REMEDIES REGARDLESS OF THE LEGAL THEORY. IN NO EVENT SHALL MILLER BE LIABLE FOR DIRECT, INDIRECT, SPECIAL, INCIDENTAL OR CONSEQUENTIAL DAMAGES (INCLUDING LOSS OF PROFIT) REGARDLESS OF THE LEGAL THEORY. ANY WARRANTY NOT PROVIDED HEREIN AND ANY IMPLIED WARRANTY, GUARANTY, OR REPRESENTATION, INCLUDING ANY IMPLIED WARRANTY OF MERCHANTABILITY OR FITNESS FOR PARTICULAR PURPOSE, ARE EXCLUDED AND DISCLAIMED BY MILLER.

Some US states do not allow limiting the duration of an implied warranty or the exclusion of certain damages, so the above limitations may not apply to you. This warranty provides specific legal rights, and other rights may be available depending on your state. In Canada, some provinces provide additional warranties or remedies, and to the extent the law prohibits their waiver, the limitations set out above may not apply. This Limited Warranty provides specific legal rights, and other rights may be available, but may vary by province.

Warranty Questions?

Call
1-800-4-A-MILLER
for your local
Miller distributor.

Your distributor also gives you ...

Service

You always get the fast, reliable response you need. Most replacement parts can be in your hands in 24 hours.

Support

Need fast answers to the tough welding questions? Contact your distributor. The expertise of the distributor and Miller is there to help you, every step of the way.





Owner's Record

Please complete and retain with your personal records.

Model Name

Serial/Style Number

Purchase Date

(Date which equipment was delivered to original customer.)

Distributor

Address

City

State

Zip



For Service

Contact a DISTRIBUTOR or SERVICE AGENCY near you.

Always provide Model Name and Serial/Style Number.

Contact your Distributor for:

Welding Supplies and Consumables

Options and Accessories

Personal Safety Equipment

Service and Repair

Replacement Parts

Training (Schools, Videos, Books)

Technical Manuals (Servicing Information and Parts)

Circuit Diagrams

Welding Process Handbooks

To locate a Distributor or Service Agency visit www.millerwelds.com or call 1-800-4-A-Miller

Contact the Delivering Carrier to:

File a claim for loss or damage during shipment.

For assistance in filing or settling claims, contact your distributor and/or equipment manufacturer's Transportation Department.

Miller Electric Mfg. LLC

An Illinois Tool Works Company
1635 West Spencer Street
Appleton, WI 54914 USA

International Headquarters—USA

USA Phone: 920-735-4505 Auto-Attended
USA & Canada FAX: 920-735-4134
International FAX: 920-735-4125

For International Locations Visit
www.MillerWelds.com

