



OM-270223E

2018-01

Processes



TIG (GTAW) Welding



MIG (GMAW) Welding

Description



Coolmate[®] 1.3

CE

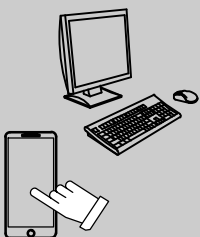
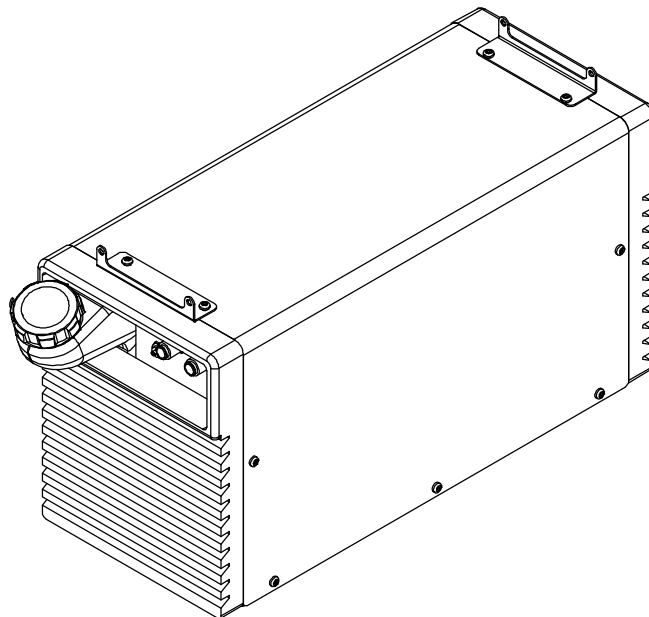

For product information,
Owner's Manual translations,
and more, visit

www.MillerWelds.com

OWNER'S MANUAL

From Miller to You

Thank you and congratulations on choosing Miller. Now you can get the job done and get it done right. We know you don't have time to do it any other way.

That's why when Niels Miller first started building arc welders in 1929, he made sure his products offered long-lasting value and superior quality. Like you, his customers couldn't afford anything less. Miller products had to be more than the best they could be. They had to be the best you could buy.

Today, the people that build and sell Miller products continue the tradition. They're just as committed to providing equipment and service that meets the high standards of quality and value established in 1929.

This Owner's Manual is designed to help you get the most out of your Miller products. Please take time to read the Safety precautions. They will help you protect yourself against potential hazards on the worksite. We've made installation and operation quick and easy. With Miller you can count on years of reliable service with proper maintenance. And if for some reason the unit needs repair, there's a Troubleshooting section that will help you figure out what the problem is. The parts list will then help you to decide which exact part you may need to fix the problem. Warranty and service information for your particular model are also provided.



Miller Electric manufactures a full line of welders and welding related equipment. For information on other quality Miller products, contact your local Miller distributor to receive the latest full line catalog or individual catalog sheets.



Working as hard as you do – every power source from Miller is backed by the most hassle-free warranty in the business.



TABLE OF CONTENTS

SECTION 1 – SAFETY PRECAUTIONS - READ BEFORE USING	1
1-1. Symbol Usage	1
1-2. Cooling Equipment Hazards	1
1-3. Additional Symbols For Installation, Operation, And Maintenance	1
1-4. California Proposition 65 Warnings	2
1-5. Principal Safety Standards	2
SECTION 2 – DEFINITIONS	3
2-1. Additional Safety Symbols And Definitions	3
2-2. Miscellaneous Symbols And Definitions	4
SECTION 3 – SPECIFICATIONS	5
3-1. Serial Number And Rating Label Location	5
3-2. Specifications*	5
3-3. Coolant Specifications	5
3-4. Environmental Specifications	5
SECTION 4 – INSTALLATION	7
4-1. Selecting a Location	7
4-2. Cooler Mounting Options	8
4-3. Connecting 115 VAC Input Power	10
SECTION 5 – OPERATION	10
5-1. Control Panel	10
SECTION 6 – MAINTENANCE & TROUBLESHOOTING	11
6-1. Routine Maintenance	11
6-2. Coolant Maintenance	11
6-3. Flow Direction	12
6-4. Troubleshooting	12
SECTION 7 – ELECTRICAL DIAGRAM	13
SECTION 8 – PARTS LIST	14
WARRANTY	



DECLARATION OF CONFORMITY

for European Community (CE marked) products.

ITW Welding Italy S.r.l Via Privata Iseo 6/E, 20098 San Giuliano M.se, (MI) Italy declares that the product(s) identified in this declaration conform to the essential requirements and provisions of the stated Council Directive(s) and Standard(s).

Product/Apparatus Identification:

Product	Stock Number
COOLMATE 1.3, CE	028042108

Council Directives:

- 2014/35/EU Low Voltage
- 2014/30/EU Electromagnetic Compatibility
- 2011/65/EU Restriction of the use of certain hazardous substances in electrical and electronic equipment

Standards:

- IEC 60974-1:2012 Arc Welding Equipment – Part 1: Welding Power Sources
- IEC 60974-2:2013 Arc Welding Equipment – Part 2: Liquid cooling systems
- IEC 60974-10:2014+A1:2015 Arc Welding Equipment – Part 10: Electromagnetic Compatibility Requirements

EU Signatory:

January 17th, 2018

Massimiliano Lavarini

Date of Declaration

ITW WELDING ITALY PRODUCTION MANAGER

956 172 307

SECTION 1 – SAFETY PRECAUTIONS - READ BEFORE USING

coolers 2018-01

 Protect yourself and others from injury — read, follow, and save these important safety precautions and operating instructions.

1-1. Symbol Usage

 **DANGER!** – Indicates a hazardous situation which, if not avoided, will result in death or serious injury. The possible hazards are shown in the adjoining symbols or explained in the text.

 Indicates a hazardous situation which, if not avoided, could result in death or serious injury. The possible hazards are shown in the adjoining symbols or explained in the text.

NOTICE – Indicates statements not related to personal injury.

 Indicates special instructions.



This group of symbols means Warning! Watch Out! ELECTRIC SHOCK, MOVING PARTS, and HOT PARTS hazards. Consult symbols and related instructions below for necessary actions to avoid the hazards.

1-2. Cooling Equipment Hazards

 The symbols shown below are used throughout this manual to call attention to and identify possible hazards. When you see the symbol, watch out, and follow the related instructions to avoid the hazard. The safety information given below is only a summary of the more complete safety information found in the Safety Standards listed in Section 1-5. Read and follow all Safety Standards.

 Only qualified persons should install, operate, maintain, and repair this equipment. A qualified person is defined as one who, by possession of a recognized degree, certificate, or professional standing, or who by extensive knowledge, training and experience, has successfully demonstrated ability to solve or resolve problems relating to the subject matter, the work, or the project and has received safety training to recognize and avoid the hazards involved.

 During operation, keep everybody, especially children, away.



HOT PARTS can burn.

- Do not touch hot parts bare handed.
- Allow cooling period before working on equipment.
- To handle hot parts, use proper tools and/or wear heavy, insulated welding gloves and clothing to prevent burns.

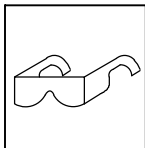

FLYING METAL or DIRT can injure eyes.

- Wear approved safety glasses with side shields even under your welding helmet.



ELECTRIC SHOCK can kill.

Touching live electrical parts can cause fatal shocks or severe burns. The input power circuit and machine internal circuits are also live when power is on. Incorrectly installed or improperly grounded equipment is a hazard.

- Do not touch live electrical parts.
- Disconnect input power or stop engine before installing or servicing this equipment. Lockout/tagout input power according to OSHA 29 CFR 1910.147 (see Safety Standards).
- Properly install, ground, and operate this equipment according to its Owner's Manual and national, state, and local codes.
- Always verify the supply ground – check and be sure that input power cord ground wire is properly connected to ground terminal in disconnect box or that cord plug is connected to a properly grounded receptacle outlet.
- Keep cords dry, free of oil and grease, and protected from hot metal and sparks.
- Frequently inspect input power cord and ground conductor for damage or bare wiring – replace immediately if damaged – bare wiring can kill.
- Turn off all equipment when not in use.
- Use only well-maintained equipment. Repair or replace damaged parts at once. Maintain unit according to manual.
- Keep all panels and covers securely in place.

1-3. Additional Symbols For Installation, Operation, And Maintenance



FALLING EQUIPMENT can injure.

- Use correct procedures and equipment of adequate capacity to lift and support unit.
- If using lift forks to move unit, be sure forks are long enough to extend beyond opposite side of unit.
- Keep equipment (cables and cords) away from moving vehicles when working from an aerial location.
- Follow the guidelines in the Applications Manual for the Revised NIOSH Lifting Equation (Publication No. 94-110) when manually lifting heavy parts or equipment.

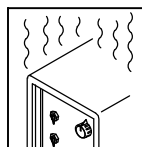

OVERUSE can cause OVERHEATING

- Allow cooling period; follow rated duty cycle.
- Do not block or filter airflow to unit.

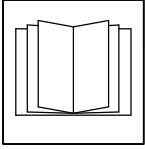

READ INSTRUCTIONS.

- Read and follow all labels and the Owner's Manual carefully before installing, operating, or servicing unit. Read the safety information at the beginning of the manual and in each section.
- Use only genuine replacement parts from the manufacturer.
- Perform installation, maintenance, and service according to the Owner's Manuals, industry standards, and national, state, and local codes.
- Read and understand the Safety Data Sheets (SDSs) and the manufacturer's instructions for adhesives, coatings, cleaners, consumables, coolants, degreasers, fluxes, and metals.



STEAM AND HOT COOLANT can burn.

Hose may rupture if coolant overheats.

- Visually inspect condition of hoses before each use. Do not use damaged hoses.
- Allow cooling period before working on equipment.



HIGH PRESSURE FLUIDS can injure or kill.

- Coolant can be under high pressure.
- Release pressure before working on cooler.
- If ANY fluid is injected into the skin or body seek medical help immediately.



MOVING PARTS can injure.

- Keep away from moving parts such as fans.
- Keep all doors, panels, covers, and guards closed and securely in place.
- Have only qualified persons remove doors, panels, covers, or guards for maintenance and troubleshooting as necessary.
- Reinstall doors, panels, covers, or guards when maintenance is finished and before reconnecting input power.

1-4. California Proposition 65 Warnings

⚠ WARNING: This product can expose you to chemicals including lead, which are known to the state of California to cause cancer and birth defects or other reproductive harm.

For more information, go to www.P65Warnings.ca.gov

1-5. Principal Safety Standards

Safety in Welding, Cutting, and Allied Processes, ANSI Standard Z49.1, is available as a free download from the American Welding Society at <http://www.aws.org> or purchased from Global Engineering Documents (phone: 1-877-413-5184, website: www.global.ihs.com).

Safe Practices for the Preparation of Containers and Piping for Welding and Cutting, American Welding Society Standard AWS F4.1, from Global Engineering Documents (phone: 1-877-413-5184, website: www.global.ihs.com).

Safe Practices for Welding and Cutting Containers that have Held Combustibles, American Welding Society Standard AWS A6.0, from Global Engineering Documents (phone: 1-877-413-5184, website: www.global.ihs.com).

National Electrical Code, NFPA Standard 70, from National Fire Protection Association, Quincy, MA 02169 (phone: 1-800-344-3555, website: www.nfpa.org and www.sparky.org).

Safe Handling of Compressed Gases in Cylinders, CGA Pamphlet P-1, from Compressed Gas Association, 14501 George Carter Way, Suite 103, Chantilly, VA 20151 (phone: 703-788-2700, website: www.cganet.com).

Safety in Welding, Cutting, and Allied Processes, CSA Standard W117.2, from Canadian Standards Association, Standards Sales, 5060 Spectrum Way, Suite 100, Mississauga, Ontario, Canada L4W 5N5 (phone: 800-463-6727, website: www.csagroup.org).

Safe Practice For Occupational And Educational Eye And Face Protection, ANSI Standard Z87.1, from American National Standards Institute, 25 West 43rd Street, New York, NY 10036 (phone: 212-642-4900, website: www.ansi.org).







Standard for Fire Prevention During Welding, Cutting, and Other Hot Work, NFPA Standard 51B, from National Fire Protection Association, Quincy, MA 02269 (phone: 1-800-344-3555, website: www.nfpa.org). OSHA, Occupational Safety and Health Standards for General Industry, Title 29, Code of Federal Regulations (CFR), Part 1910.177 Subpart N, Part 1910 Subpart Q, and Part 1926, Subpart J, from U.S. Government Printing Office, Superintendent of Documents, P.O. Box 371954, Pittsburgh, PA 15250-7954 (phone: 1-866-512-1800) (there are 10 OSHA Regional Offices—phone for Region 5, Chicago, is 312-353-2220, website: www.osha.gov).

Applications Manual for the Revised NIOSH Lifting Equation, The National Institute for Occupational Safety and Health (NIOSH), 1600 Clifton Rd, Atlanta, GA 30329-4027 (phone: 1-800-232-4636, website: www.cdc.gov/NIOSH).

SECTION 2 – DEFINITIONS

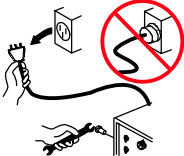
2-1. Additional Safety Symbols And Definitions

 Some symbols are found only on CE products.

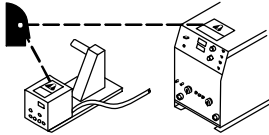
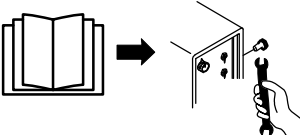
	<p>Warning! Watch Out! There are possible hazards as shown by the symbols.</p> <p style="text-align: right;">Safe1 2012-05</p>
	<p>Do not discard product (where applicable) with general waste. Reuse or recycle Waste Electrical and Electronic Equipment (WEEE) by disposing at a designated collection facility. Contact your local recycling office or your local distributor for further information.</p> <p style="text-align: right;">Safe37 2017-04</p>
	<p>Disconnect input plug or power before working on machine.</p> <p style="text-align: right;">Safe5 2017-04</p>
	<p>Do not remove or paint over (cover) the label.</p> <p style="text-align: right;">Safe20 2017-04</p>
	<p>Recycle.</p> <p style="text-align: right;">Safe103 2012-09</p>
	<p>Use coolant suggested by the manufacturer.</p> <p style="text-align: right;">Safe52 2012-05</p>
	<p>Please drain fluid according to instructions.</p> <p style="text-align: right;">2012-05</p>
	<p>Read the labels on the welding power source, wire feeder, or other major equipment for welding safety information.</p> <p style="text-align: right;">Safe71 2012-06</p>
	<p>Read the Owner's Manual before working on this machine.</p> <p style="text-align: right;">Safe70 2012-06</p>

SECTION 3 – SPECIFICATIONS

3-1. Serial Number And Rating Label Location

The serial number and rating information for this product is located on the back panel. Use rating label to determine input power requirements and/or rated output. For future reference, write serial number in space provided on cover of this manual.

3-2. Specifications*

☞ Do not use information in unit specifications table to determine electrical service requirements. See Sections 4-3 for information on connecting input power.

☞ This equipment will deliver rated output at an ambient air temperature up to 104 °F (40 °C).

Model	Coolant Tank Capacity	Maximum Cooling Capacity	Input Power	Dimensions	Weight
Coolmate 1.3 CE	5 L	1470 Watts (5020 BTU/hr) 1.0 L/min (1.1 qt/min)	Single Phase 115 VAC 50/60 Hz 2.5 Amperes	Length: 620 mm Height: 320 mm Width: 227 mm	20 kg

*IEC Cooling Capacity States That The Water Inlet Temperature Can Not Exceed 40° C Above Ambient Temperature At A 1l/ Min Flow Rate.
 **Plug Is Customer Supplied.
 Recirculating Coolant System For Water-Cooled GTAW Torches And GMAW Guns.
 Use With Guns/Torches Rated Up To 280 Amperes

3-3. Coolant Specifications

 Do not use conductive coolant.

Application	Coolant
GTAW Or Where High Frequency Current Is Used	Coolant 050024004 Low Conductivity Coolant 043810* Distilled Or Deionized Water Okay Above 32°F (0°C)
GMAW Or Where High Frequency Current Is Not Used	Coolant 050024004 Low Conductivity Coolant 043810* Aluminum Protecting Coolant 043809* Distilled Or Deionized Water Okay Above 32°F (0°C)
Where Coolant Contacts Aluminum Parts	Aluminum Protecting Coolant 043809*

*Coolants 043810 and 043809 protect to -37°F (-38°C) and resist algae growth.
NOTICE – Use of any coolant other than those listed in the table voids the warranty on any parts that come in contact with the coolant (pump, radiator, etc.).

3-4. Environmental Specifications

A. IP Rating

IP Rating
IP23 This equipment is designed for outdoor use.

IP23 2017-02

B. Information On Electromagnetic Compatibility (EMC)

 This Class A equipment is not intended for use in residential locations where the electrical power is provided by the public low-voltage supply system. There can be potential difficulties in ensuring electromagnetic compatibility in those locations, due to conducted as well as radiated disturbances. This equipment complies with IEC 61000-3-11 and IEC 61000-3-12.	ce-emc 4 2014-07
---	------------------

C. Temperature Specifications

Operating Temperature Range	Storage/Transportation Temperature Range
-10 to 40°C (14 to 104 °F)	20 to 25°C (68 to 77 °F)

Temp1_016-08

☞ The correction factor on the cooling power at an ambient temperature of 104 °F (40 °C) is 0.625.

SECTION 4 – INSTALLATION

4-1. Selecting a Location

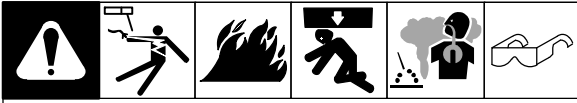

⚠ Do not move or operate unit where it could tip.

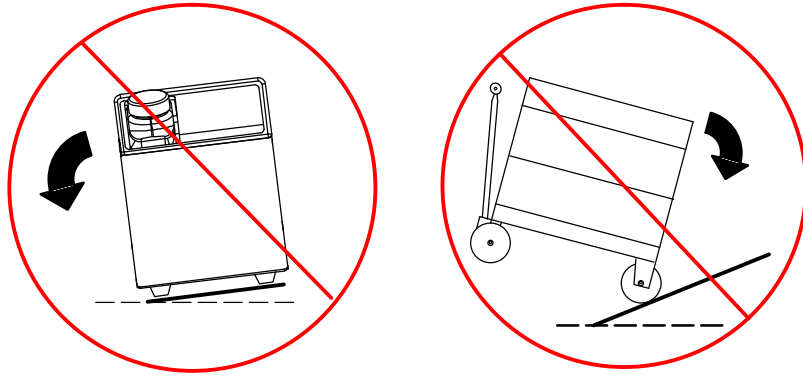

 Position unit so air can circulate.

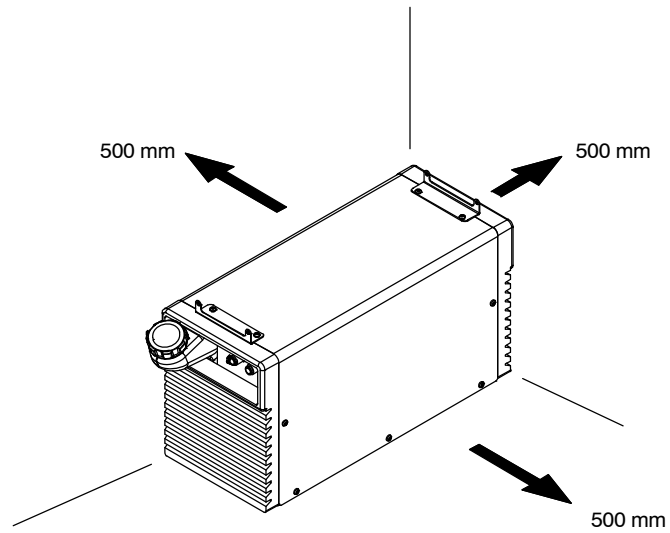

4-2. Cooler Mounting Options



A. Mounting Cooler To A Small Runner Cart

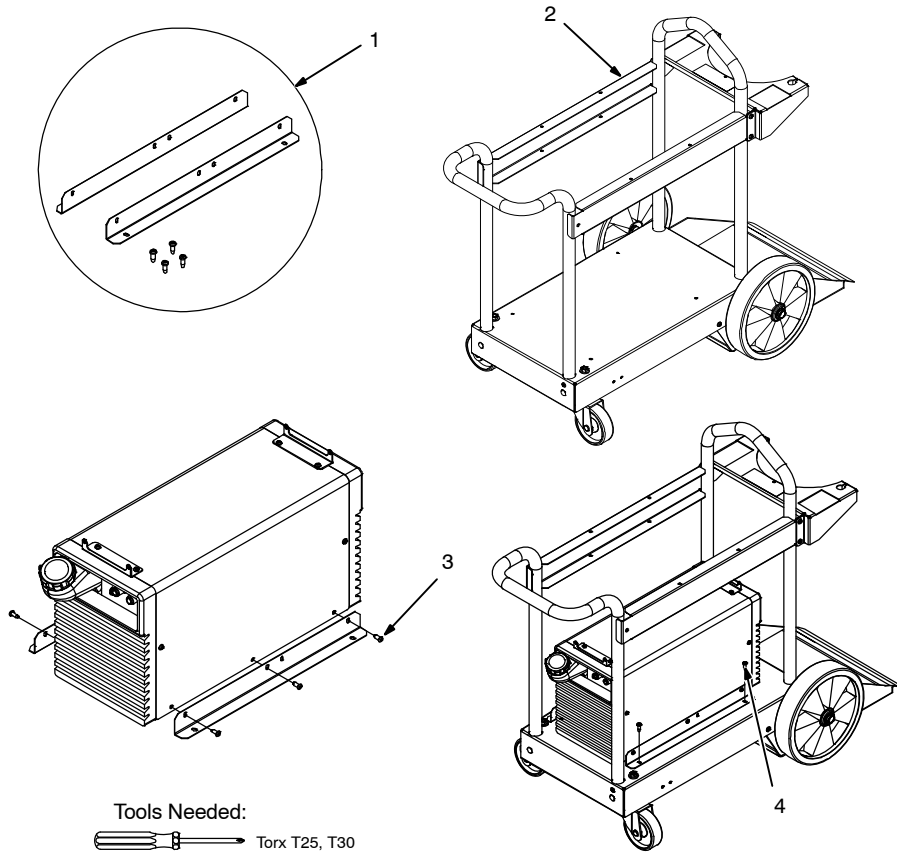

Tools Needed:



A. Mounting Cooler To A Small Runner Cart

- 1 Mounting Bracket Kit
028066299
- 2 Small Runner Cart – Part No.
300988 – Not Supplied
- 3 Wrapper Screws

Remove screws from wrapper and use screws to secure brackets to machine.

- 4 Screws

Use screws supplied with Kit 028066299 to secure machine to cart.

956172191_2-A

B. Mounting Cooler To An MH Trolley

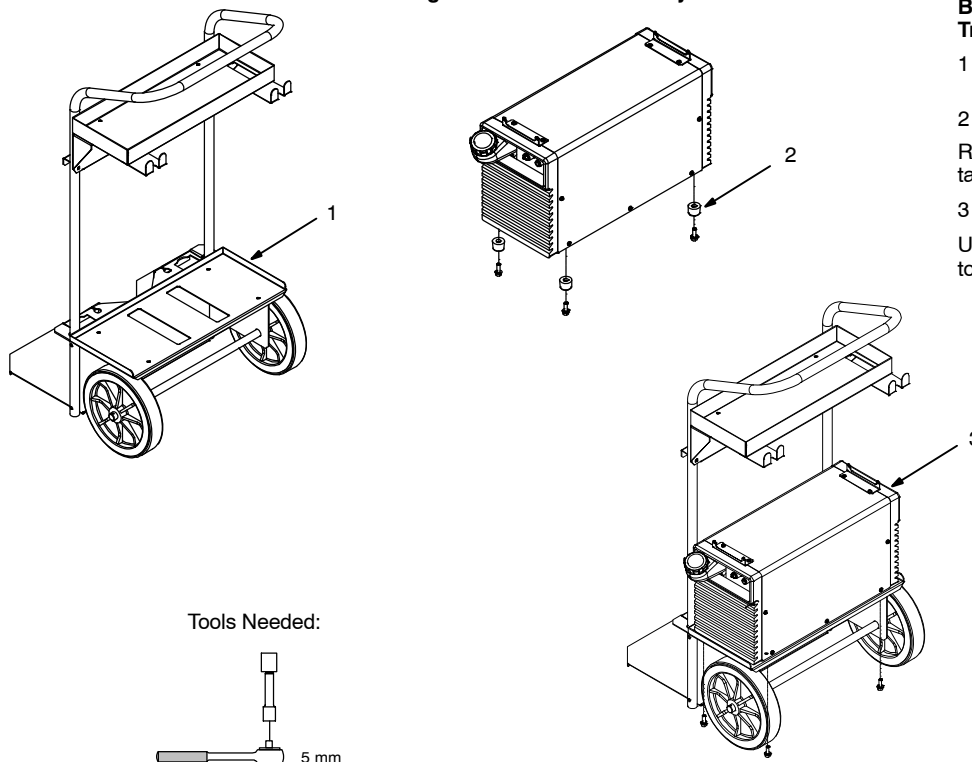

Tools Needed:

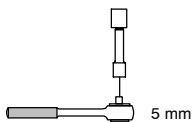

B. Mounting Cooler To An MH Trolley

- 1 MH Trolley – Part No. 01835026
– Not Supplied

- 2 Fixing Foot – Supplied w/Cart

Remove rubber feet from cooler, retain hardware.

- 3 Securing Cooler To Trolley

Use existing screws to secure cooler to trolley.

956172191_3-A

C. Mounting Cooler To A Maxstar® 280/Dynasty® 280

C. Mounting Cooler To A Maxstar 280 Or Dynasty 280

1 Maxstar 280 Or Dynasty 280
– (Not Supplied)

2 Mounting Hardware

Remove screws from bottom of power source front and rear panels as shown.

Place power source on cooler between the mounting brackets and secure with the just removed hardware.

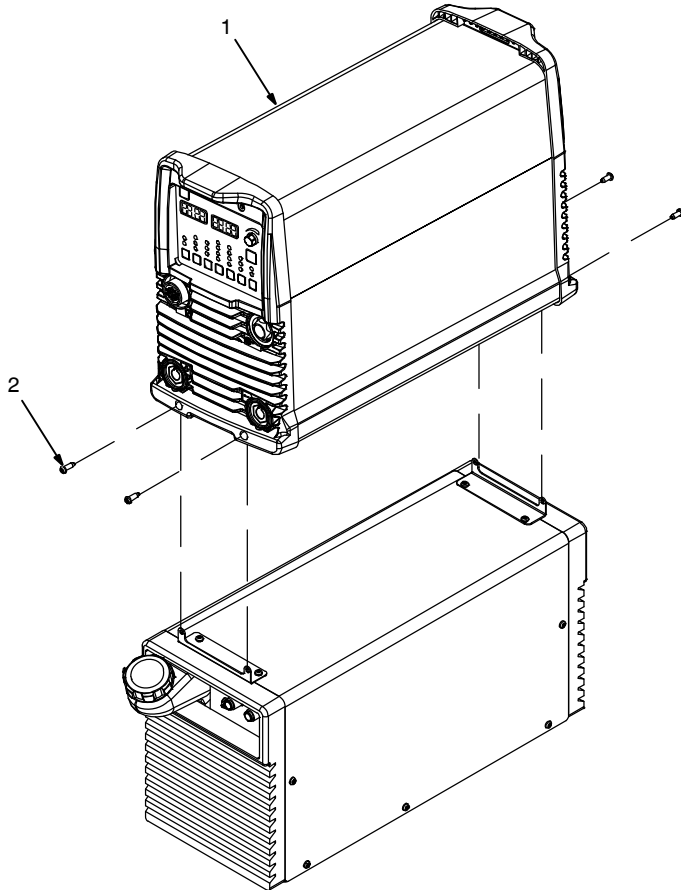

Tools Needed:



Torx T25

956172191_4-A

4-3. Connecting 115 VAC Input Power

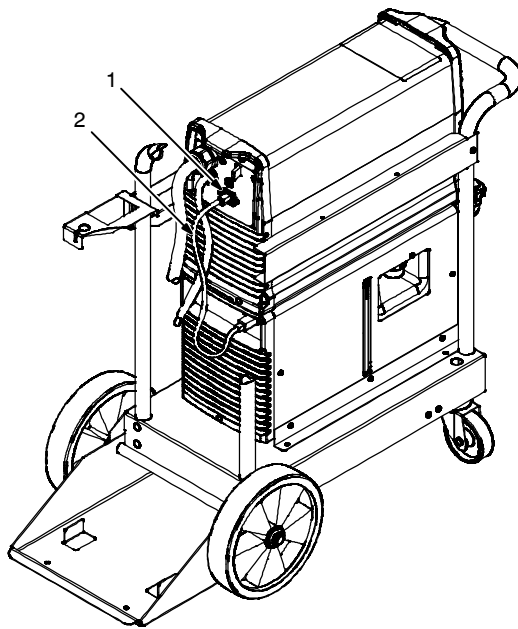

- 1 Coolmate 1.3 power Receptacle
 - 2 Cooler Power Cord
- Provides 115 VAC to power cooler.

NOTICE – The Coolmate 1.3 is designed only for use with Dynasty® 280 and Maxstar® 280 Models.

SECTION 5 – OPERATION

5-1. Control Panel

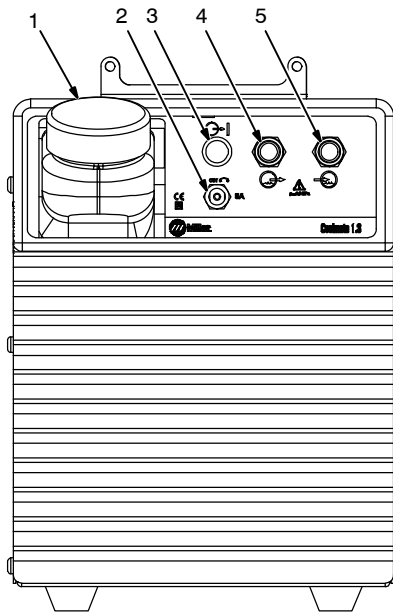

Front

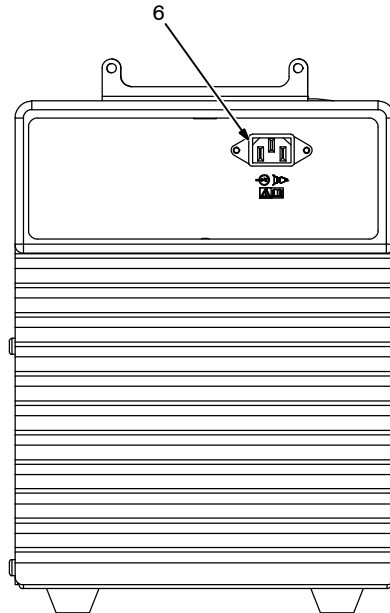











Back

- 1 Tank Filler Neck
- 2 Supplementary Protector (CB1)
- 3 Power On/Off Light
- 4 Quick Connect; Water Out
- 5 Quick Connect; Water In
- 6 Panel Plug





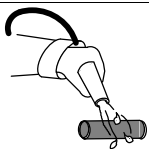
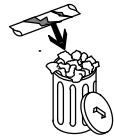
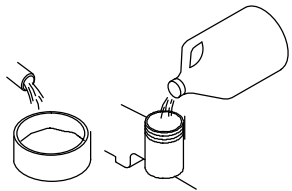

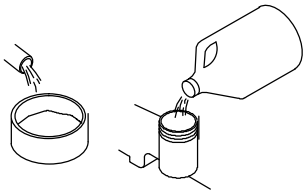

956172191_6-A

SECTION 6 – MAINTENANCE & TROUBLESHOOTING

6-1. Routine Maintenance

     		 Disconnect power before maintaining.
	✓ = Check ◇ = Change ● = Clean ☆ = Replace * To be done by Factory Authorized Service Agent	Reference
Every 3 Months	 <p>NOTICE – Clean coolant filter. Severe conditions may require more frequent cleaning (continuous use, high/low temperatures, dirty environment, etc.). Failure to properly clean coolant filter voids pump warranty.</p>	
● Coolant Filter	 <p>☆Cracked Parts</p>  <p>◇Change Coolant (If Using Water)</p>  <p>☆Replace Unreadable Labels</p>	
Every 12 Months	 <p>◇Change Coolant</p>	

6-2. Coolant Maintenance

     		 Disconnect cooler plug from welding power source receptacle before maintaining.
 Dispose of used coolant according to national, state, and local codes. Do not pour down drain.		
<p>1 Cooler Side Panel 2 Coolant Level Indicator 3 Coolant Filter</p>		
<p>Unscrew housing to clean filter and housing.</p>		
<p>Changing Coolant</p> <p>Drain coolant by tipping unit forward. Fill with clean water and run for 10 minutes. Drain and refill.</p>		
<p>NOTICE – If replacing hoses, use hoses compatible with ethylene glycol, such as Buna-n, Neoprene, or Hypalon. Oxy-acetylene hoses are not compatible with any product containing ethylene glycol.</p>		

956172191_7-A

6-3. Flow Direction

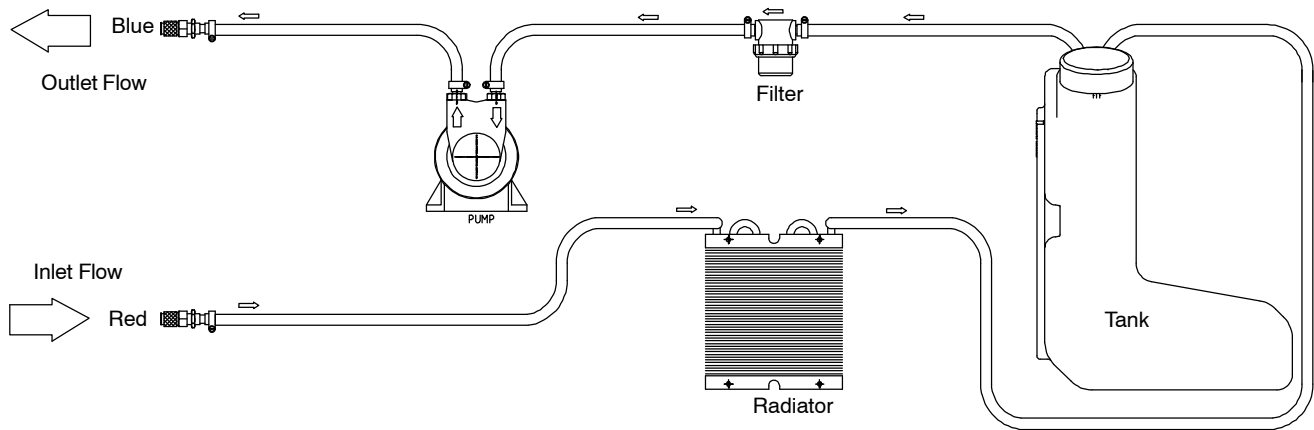
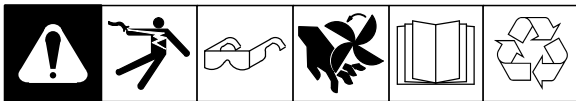

956172140-A

6-4. Troubleshooting

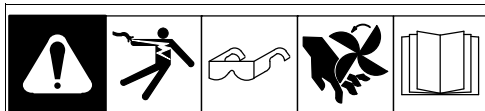

Trouble	Remedy
Coolant system does not work.	Be sure cooler input power and communication cables from power source are connected to cooler receptacles.
	Check input power line fuses or circuit breaker, and replace or reset if necessary.
	Have Factory Authorized Service Agent check motor.
Decreased or no coolant flow.	Add coolant.
	Check for clogged hoses or coolant filter. Clean filter or clean / replace hoses if necessary.
	Disconnect pump, and check for sheared coupling. Replace coupling if necessary.

SECTION 7 - ELECTRICAL DIAGRAM

	⚠ WARNING • Do not touch live electrical parts. • Disconnect input power or stop engine before servicing. • Do not operate with covers removed. • Have only qualified persons install, use, or service this unit.
	ELECTRIC SHOCK HAZARD

PLG1

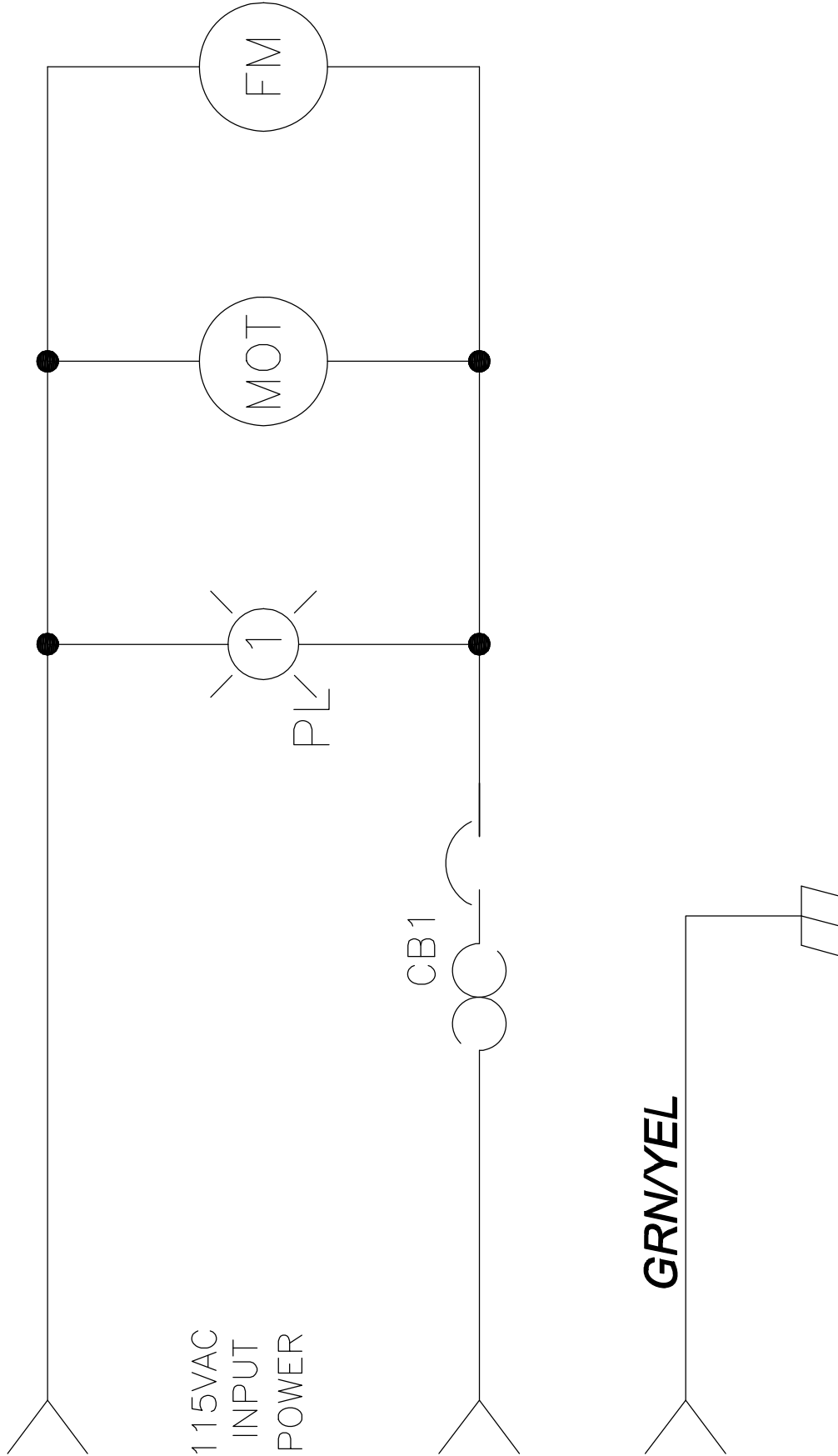

SECTION 8 – PARTS LIST

 Hardware is common and not available unless listed.

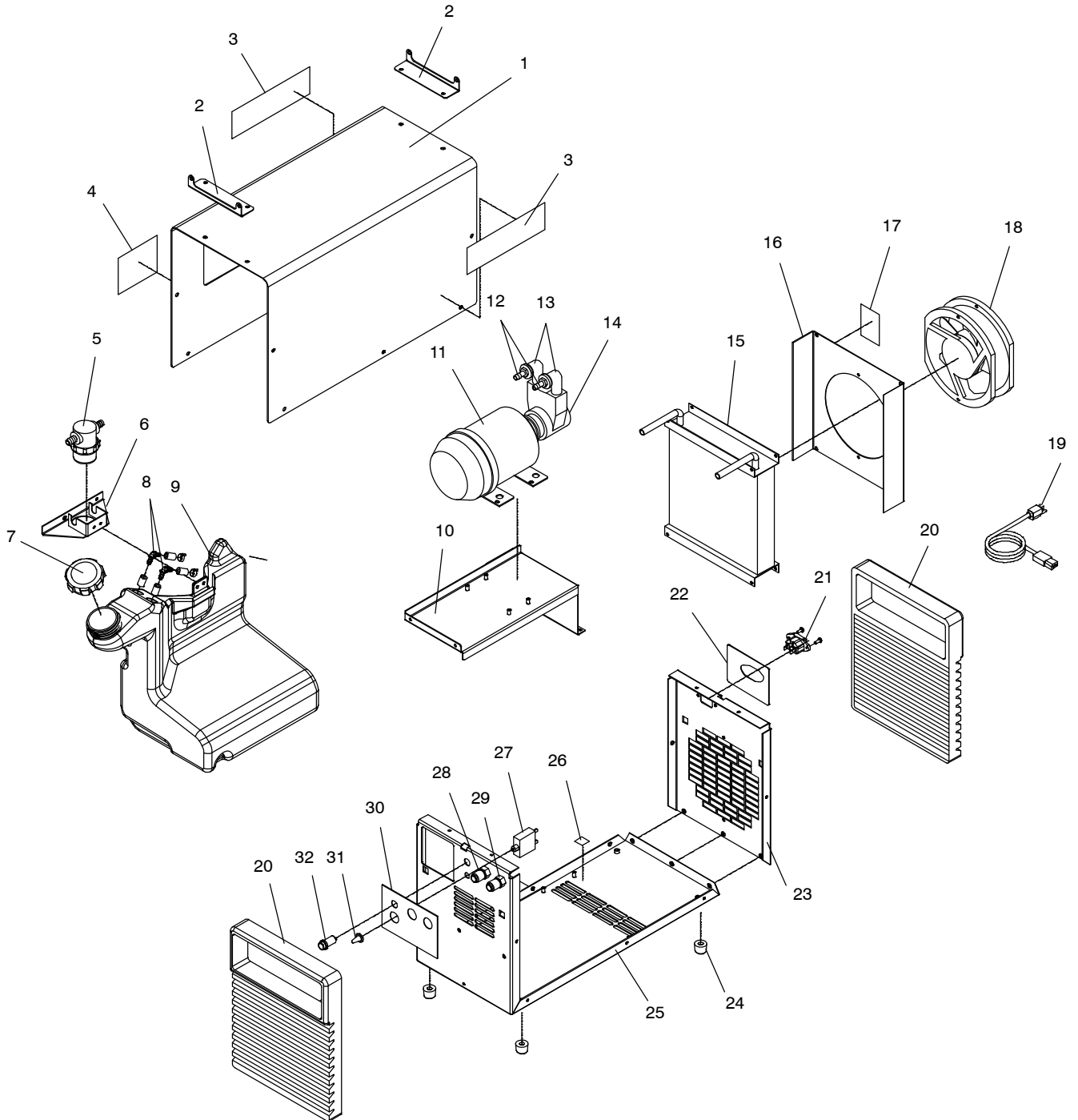

95617219185-A

Figure 8-1. Main Assembly, Coolmate 1.3 CE

Item No.	Dia. Mkgs.	Part No.	Description
----------	------------	----------	-------------

Figure 8-1. Main Assembly, Coolmate 1.3 CE

... 1	...	+116121128	.. Wrapper	1
... 2	...	156005187	.. Bracket, Mtg Welding Power Supply	2
... 3	...	180663	.. Label, Warning Primary Connections	2
... 4	...	207290	.. Label, Advisory Service	1
... 5	...	166564	.. Filter, In-Line Low Profile 100 Screen 3/8 Hose Bar	1
... 6	...	235419	.. Bracket, Filter	1
... 7	...	166608	.. Cap, Tank Screw	1
... 8	...	231311	.. Hose, Nyl Barbed Elbow 3/8 x 3/8 90 Deg	2
... 9	...	251119	.. Tank, Water 5 L	1
... 10	...	156005186	.. Mtg Bracket, Motor & Transformer	1
... 11	... MOT	057010059	.. Motor, 170 W, 115 VAC	1
... 12	...	556049386	.. Connector, Male 3/8 D.10	2
... 13	...	556049419	.. Elbow Pipe, Male/Female 3/8	2
... 14	...	V57011071	.. Pump Assy	1
... 15	...	056082104	.. Radiator Assy	1
... 16	...	+156005188	.. Fan Support	1
... 17	...	956142629	.. Label, Warning Moving Parts	1
... 18	... FM	213072	.. Fan Assy, Radiator Cooling 115 V	1
... 19	...	255814	.. Cable, Power	1
... 20	...	251125	.. Bezel, Front/Rear	2
... 21	... PLG1	254162	.. RCPT, Str Grd 2P3W 15A 250V (Black) IEC 320 C14	1
... 22	...	316029732	.. Nameplate, Rear	1
... 23	...	116118182	.. Panel, Rear	1
... 24	...	656110013	.. Foot, Rubber Mount	4
... 25	...	116006134	.. Base	1
... 26	...	155436	.. Label, Ground	1
... 27	... CB1	083431	.. Breaker, Circuit 5A	1
... 28	...	556049410	.. Water Connection, Quick Connect, Blue	1
... 29	...	556049409	.. Water Connection, Quick Connect, Red	1
... 30	...	316029731	.. Nameplate, Front	1
... 31	...	156033034	.. Boot, Rubber	1
... 32	... PL1	056072081	.. Light, WHT lens 115 VAC, neon	1

+When ordering a component originally displaying a precautionary label, the label should also be ordered.

To maintain the factory original performance of your equipment, use only Manufacturer's Suggested Replacement Parts. Model and serial number required when ordering parts from your local distributor.

TRUE BLUE® WARRANTY

Effective January 1, 2018
(Equipment with a serial number preface of MJ or newer)

This limited warranty supersedes all previous Miller warranties and is exclusive with no other guarantees or warranties expressed or implied.

LIMITED WARRANTY – Subject to the terms and conditions below, ITW Welding Products Italy warrants to its original retail purchaser that new Miller equipment sold after the effective date of this limited warranty is free of defects in material and workmanship at the time it is shipped by Miller. THIS WARRANTY IS EXPRESSLY IN LIEU OF ALL OTHER WARRANTIES, EXPRESS OR IMPLIED, INCLUDING THE WARRANTIES OF MERCHANTABILITY AND FITNESS.

Within the warranty periods listed below, Miller will repair or replace any warranted parts or components that fail due to such defects in material or workmanship. Miller must be notified in writing within thirty (30) days of such defect or failure, at which time Miller will provide instructions on the warranty claim procedures to be followed. If notification is submitted as an online warranty claim, the claim must include a detailed description of the fault and the troubleshooting steps taken to identify failed components and the cause of their failure.

Miller shall honor warranty claims on warranted equipment listed below in the event of such a failure within the warranty time periods. All warranty time periods start on the date the equipment was delivered to the original retail purchaser or one year after the equipment is shipped to a European distributor or twelve months after the equipment is shipped to an International distributor.

1. 5 Years Parts — 3 Years Labor
 - * Original main power rectifiers only to include SCRs, diodes, and discrete rectifier modules with exclusion of STR, Si, STi, STH and MPi series.
2. 3 Years — Parts and Labor
 - * Engine Driven Welding Generators
(NOTE: Engines are warranted separately by the engine manufacturer.)
 - * Inverter Power Sources (Unless Otherwise Stated)
 - * Process Controllers
 - * Semi-Automatic and Automatic Wire Feeders
 - * Transformer/Rectifier Power Sources
3. 2 Years — Parts
 - * Auto-Darkening Helmet Lenses (No Labor)
 - * Migmatic 175
 - * HF Units
4. 1 Year — Parts and Labor Unless Specified
 - * Automatic Motion Devices
 - * Field Options
(NOTE: Field options are covered under True Blue® for the remaining warranty period of the product they are installed in, or for a minimum of one year — whichever is greater.)
 - * Induction Heating Power Sources, Coolers, and Electronic Controls/Recorders
 - * Motor-Driven Guns (w/exception of Spoolmate Spoolguns)
 - * Positioners and Controllers
 - * Powered Air Purifying Respirator (PAPR) Blower Unit (No Labor)
 - * Racks
 - * Running Gear and Trailers
 - * Subarc Wire Drive Assemblies
 - * Water Cooling Systems
 - * Work Stations/Weld Tables (No Labor)
5. 6 Months — Parts
 - * Batteries

6. 90 Days — Parts
 - * Accessory (Kits)
 - * Canvas Covers
 - * Induction Heating Coils and Blankets
 - * MIG Guns
 - * Remote Controls
 - * Replacement Parts (No Labor)
 - * Spoolmate Spoolguns
 - * Cables and Non-Electronic Controls

Miller's True Blue® Limited Warranty shall not apply to:

1. **Consumable components; such as contact tips, cutting nozzles, contactors, brushes, switches, slip rings, relays or parts that fail due to normal wear.**
2. Items furnished by Miller, but manufactured by others, such as engines or trade accessories. These items are covered by the manufacturer's warranty, if any.
3. Equipment that has been modified by any party other than Miller, or equipment that has been improperly installed, improperly operated or misused based upon industry standards, or equipment which has not had reasonable and necessary maintenance, or equipment which has been used for operation outside of the specifications for the equipment.

MILLER PRODUCTS ARE INTENDED FOR COMMERCIAL AND INDUSTRIAL USERS TRAINED AND EXPERIENCED IN THE USE AND MAINTENANCE OF WELDING EQUIPMENT.

The exclusive remedies for warranty claims are, at Miller's option, either: (1) repair; or (2) replacement; or, if approved in writing by Miller, (3) the pre-approved cost of repair or replacement at an authorized Miller service station; or (4) payment of or credit for the purchase price (less reasonable depreciation based upon use). Products may not be returned without Miller's written approval. Return shipment shall be at customer's risk and expense.

The above remedies are F.O.B., Factory at ITW Welding Products Group Europe or Miller's authorized service facility. Transportation and freight are the customer's responsibility. TO THE EXTENT PERMITTED BY LAW, THE REMEDIES HEREIN ARE THE SOLE AND EXCLUSIVE REMEDIES REGARDLESS OF THE LEGAL THEORY. IN NO EVENT SHALL MILLER BE LIABLE FOR DIRECT, INDIRECT, SPECIAL, INCIDENTAL OR CONSEQUENTIAL DAMAGES (INCLUDING LOSS OF PROFIT) REGARDLESS OF THE LEGAL THEORY. ANY WARRANTY NOT PROVIDED HEREIN AND ANY IMPLIED WARRANTY, GUARANTY, OR REPRESENTATION, INCLUDING ANY IMPLIED WARRANTY OF MERCHANTABILITY OR FITNESS FOR PARTICULAR PURPOSE, ARE EXCLUDED AND DISCLAIMED BY MILLER.





Owner's Record

Please complete and retain with your personal records.

Model Name

Serial/Style Number

Purchase Date

(Date which equipment was delivered to original customer.)

Distributor

Address

Country

Zip/Postal Code



For Service

Contact a *DISTRIBUTOR* or *SERVICE AGENCY* near you.

Always provide Model Name and Serial/Style Number.

Contact your Distributor for:

Welding Supplies and Consumables

Options and Accessories

Service and Repair

Replacement Parts

Owner's Manuals

Contact the Delivering Carrier to:

File a claim for loss or damage during shipment.

For assistance in filing or settling claims, contact your distributor and/or equipment manufacturer's Transportation Department.

ITW Welding Italy S.r.l.

Via Privata Iseo, 6/E

20098 San Giuliano

Milanese, Italy

Phone: 39 (0) 2982901

Fax: 39 (0) 298290-203

email: miller@itw-welding.it

