



OM-265364K

2016-10

**Processes**



Submerged Arc (SAW) Welding  
Electroslag (ESW) Welding

**Description**



Arc Welding Power Source

# SubArc AC/DC Digital, 1000 Amp SubArc AC/DC 1250 Digital Power Sources CE

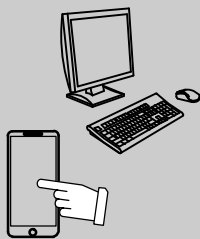
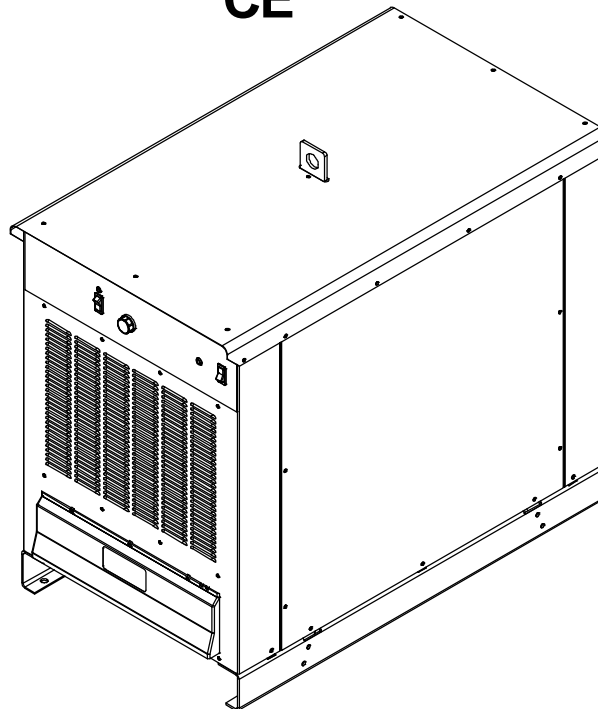

For product information,  
Owner's Manual translations,  
and more, visit

[www.MillerWelds.com](http://www.MillerWelds.com)

## OWNER'S MANUAL

File: Submerged (SAW)



# From Miller to You

---

*Thank you and congratulations* on choosing Miller. Now you can get the job done and get it done right. We know you don't have time to do it any other way.

That's why when Niels Miller first started building arc welders in 1929, he made sure his products offered long-lasting value and superior quality. Like you, his customers couldn't afford anything less. Miller products had to be more than the best they could be. They had to be the best you could buy.

Today, the people that build and sell Miller products continue the tradition. They're just as committed to providing equipment and service that meets the high standards of quality and value established in 1929.

This Owner's Manual is designed to help you get the most out of your Miller products. Please take time to read the Safety precautions. They will help you protect yourself against potential hazards on the worksite.

We've made installation and operation quick and easy. With Miller you can count on years of reliable service with proper maintenance. And if for some reason the unit needs repair, there's a Troubleshooting section that will help you figure out what the problem is. The parts list will then help you to decide the exact part you may need to fix the problem. Warranty and service information for your particular model are also provided.



Miller is the first welding equipment manufacturer in the U.S.A. to be registered to the ISO 9001 Quality System Standard.

Miller Electric manufactures a full line of welders and welding related equipment. For information on other quality Miller products, contact your local Miller distributor to receive the latest full line catalog or individual specification sheets. **To locate your nearest distributor or service agency call 1-800-4-A-Miller, or visit us at [www.MillerWelds.com](http://www.MillerWelds.com) on the web.**



Working as hard as you do – every power source from Miller is backed by the most hassle-free warranty in the business.



# TABLE OF CONTENTS

<b>SECTION 1 – SAFETY PRECAUTIONS - READ BEFORE USING</b> .....	<b>1</b>
1-1. Symbol Usage .....	1
1-2. Arc Welding Hazards .....	1
1-3. Additional Symbols For Installation, Operation, And Maintenance .....	3
1-4. California Proposition 65 Warnings .....	4
1-5. Principal Safety Standards .....	4
1-6. EMF Information .....	4
<b>SECTION 2 – CONSIGNES DE SÉCURITÉ – LIRE AVANT UTILISATION</b> .....	<b>5</b>
2-1. Symboles utilisés .....	5
2-2. Dangers relatifs au soudage à l'arc .....	5
2-3. Dangers supplémentaires en relation avec l'installation, le fonctionnement et la maintenance .....	7
2-4. Proposition californienne 65 Avertissements .....	8
2-5. Principales normes de sécurité .....	8
2-6. Informations relatives aux CEM .....	8
<b>SECTION 3 – DEFINITIONS</b> .....	<b>9</b>
3-1. Additional Safety Symbols And Definitions .....	9
3-2. Miscellaneous Symbols And Definitions .....	11
<b>SECTION 4 – SPECIFICATIONS</b> .....	<b>12</b>
4-1. Serial Number And Rating Label Location .....	12
4-2. Specifications .....	12
4-3. SubArc System Compatibility .....	12
4-4. Environmental Specifications .....	12
4-5. Duty Cycle and Overheating .....	14
4-6. Static Characteristics .....	14
<b>SECTION 5 – INSTALLATION</b> .....	<b>15</b>
5-1. Dimensions And Weight .....	15
5-2. Selecting A Location .....	16
5-3. Typical Equipment Location .....	16
5-4. Electrical Service Guide .....	17
5-5. Connecting Input Power .....	18
5-6. Matching Primary Lines L1, L2, And L3 When Using Multiple AC Units .....	20
5-7. Cable Routing Diagram .....	21
<b>SECTION 6 – SYSTEM CONNECTIONS</b> .....	<b>22</b>
6-1. Terminal Strip TE2 and Remote Receptacle RC1 Information For Power Sources .....	22
6-2. Terminal Strip TE1 .....	24
<b>SECTION 7 – MAKING WELD OUTPUT CONNECTIONS</b> .....	<b>25</b>
7-1. Weld Output Terminals And Selecting Cable Sizes* .....	25
7-2. Weld Output Terminals .....	25
7-3. Connecting Weld Output Cables .....	26
7-4. Work And Electrode Cable Connections For Single DC or AC Arcs .....	26
7-5. Basic Subarc (SAW) Welding .....	27
7-6. Connecting Multiple Units .....	30
<b>SECTION 8 – POWER SOURCE OPERATION</b> .....	<b>31</b>
8-1. Front Panel Controls For CE And Non-CE Models .....	31
<b>SECTION 9 – PLC OPERATION</b> .....	<b>32</b>
9-1. Automation Interface Hardware Configuration (PLC Users Only) .....	32
9-2. Connection To PLC .....	33
9-3. Example Power Source Operation Using A PLC .....	33

# TABLE OF CONTENTS

---

<b>SECTION 10 – MAINTENANCE AND TROUBLESHOOTING</b> .....	<b>37</b>
10-1. SubArc System Help Codes .....	37
10-2. Power Source Routine Maintenance .....	39
10-3. Fuse F1 .....	39
10-4. Access Area Supplementary Protectors .....	40
10-5. Power Source Troubleshooting .....	40
<b>SECTION 11 – ELECTRICAL DIAGRAMS</b> .....	<b>42</b>
<b>WARRANTY</b>	
<b>COMPLETE PARTS LIST – Available at <a href="http://www.MillerWelds.com">www.MillerWelds.com</a></b>	



# DECLARATION OF CONFORMITY

for European Community (CE marked) products.

**MILLER Electric Mfg. Co., 1635 Spencer Street, Appleton, WI 54914 U.S.A. declares that the product(s) identified in this declaration conform to the essential requirements and provisions of the stated Council Directive(s) and Standard(s).**

Product/Apparatus Identification:

Product	Stock Number
SubArc AC/DC Digital, 1000 Amp	907620
SubArc AC/DC 1250 Digital	907621

Council Directives:

- 2014/35/EU Low Voltage
- 2014/30/EU Electromagnetic Compatibility
- 2011/65/EU Restriction of the use of certain hazardous substances in electrical and electronic equipment

Standards:

- IEC 60974-1:2012 Arc welding equipment – Part 1: Welding power sources
- IEC 60974-10:2007 Arc Welding Equipment – Part 10: Electromagnetic compatibility (EMC) requirements

Signatory:

May 19, 2016

---

**David A. Werba**  
MANAGER, PRODUCT DESIGN COMPLIANCE

---

Date of Declaration

# EMF DATA SHEET FOR ARC WELDING POWER SOURCE



## Product/Apparatus Identification

Product	Stock Number
SUBARC AC/DC 1250 DIGITAL	907621
SUBARC AC/DC DIGITAL, 1000 AMP	907620

## Compliance Information Summary

Applicable regulation                      Directive 2014/35/EU

Reference limits                              Directive 2013/35/EU, Recommendation 1999/519/EC

Applicable standards                        IEC 62822-1:2016, IEC 62822-2:2016

Intended use                                   for occupational use                       for use by laymen

Non-thermal effects need to be considered for workplace assessment                       YES                       NO

Thermal effects need to be considered for workplace assessment                       YES                       NO

Data is based on maximum power source capability (valid unless firmware/hardware is changed)

Data is based on worst case setting/program (only valid until setting options/welding programs are changed)

Data is based on multiple settings/programs (only valid until setting options/welding programs are changed)

Occupational exposure is below the Exposure Limit Values (ELVs) for health effects at the standardized configurations                       YES                       NO  
(if NO, specific required minimum distances apply)

Occupational exposure is below the Exposure Limit Values (ELVs) for sensory effects at the standardized configurations                       n.a                       YES                       NO  
(if applicable and NO, specific measures are needed)

Occupational exposure is below the Action Levels (ALs) at the standardized configurations                       n.a                       YES                       NO  
(if applicable and NO, specific signage is needed)

## EMF Data for Non-thermal Effects

Exposure Indices (EIs) and distances to welding circuit (for each operation mode, as applicable)

	Head		Trunk	Limb (hand)	Limb (thigh)
	Sensory Effects	Health Effects			
Standardized distance	10 cm	10 cm	10 cm	3 cm	3 cm
ELV EI @ standardized distance	0.36	0.14	0.23	0.13	0.30
Required minimum distance	2 cm	1 cm	1 cm	1 cm	1 cm

Distance where all occupational ELV Exposure Indices fall below 0.20 (20%)                      22 cm

Distance where all general public ELV Exposure Indices fall below 1.00 (100%)                      250 cm

Tested by:                      Tony Samimi                      Date tested:                      2016-03-04

275588-B

# SECTION 1 – SAFETY PRECAUTIONS - READ BEFORE USING

som 2015-09

 Protect yourself and others from injury — read, follow, and save these important safety precautions and operating instructions.

## 1-1. Symbol Usage



**DANGER!** – Indicates a hazardous situation which, if not avoided, will result in death or serious injury. The possible hazards are shown in the adjoining symbols or explained in the text.



Indicates a hazardous situation which, if not avoided, could result in death or serious injury. The possible hazards are shown in the adjoining symbols or explained in the text.

**NOTICE** – Indicates statements not related to personal injury.

 Indicates special instructions.



This group of symbols means Warning! Watch Out! ELECTRIC SHOCK, MOVING PARTS, and HOT PARTS hazards. Consult symbols and related instructions below for necessary actions to avoid the hazards.

## 1-2. Arc Welding Hazards



The symbols shown below are used throughout this manual to call attention to and identify possible hazards. When you see the symbol, watch out, and follow the related instructions to avoid the hazard. The safety information given below is only a summary of the more complete safety information found in the Safety Standards listed in Section 1-5. Read and follow all Safety Standards.



Only qualified persons should install, operate, maintain, and repair this unit.



During operation, keep everybody, especially children, away.



### ELECTRIC SHOCK can kill.

Touching live electrical parts can cause fatal shocks or severe burns. The electrode and work circuit is electrically live whenever the output is on. The input power circuit and machine internal circuits are also live when power is on. In semiautomatic or automatic wire welding, the wire, wire reel, drive roll housing, and all metal parts touching the welding wire are electrically live. Incorrectly installed or improperly grounded equipment is a hazard.

- Do not touch live electrical parts.

- Wear dry, hole-free insulating gloves and body protection.
- Insulate yourself from work and ground using dry insulating mats or covers big enough to prevent any physical contact with the work or ground.
- Do not use AC output in damp areas, if movement is confined, or if there is a danger of falling.
- Use AC output ONLY if required for the welding process.
- If AC output is required, use remote output control if present on unit.
- Additional safety precautions are required when any of the following electrically hazardous conditions are present: in damp locations or while wearing wet clothing; on metal structures such as floors, gratings, or scaffolds; when in cramped positions such as sitting, kneeling, or lying; or when there is a high risk of unavoidable or accidental contact with the workpiece or ground. For these conditions, use the following equipment in order presented: 1) a semiautomatic DC constant voltage (wire) welder, 2) a DC manual (stick) welder, or 3) an AC welder with reduced open-circuit voltage. In most situations, use of a DC, constant voltage wire welder is recommended. And, do not work alone!
- Disconnect input power or stop engine before installing or servicing this equipment. Lockout/tagout input power according to OSHA 29 CFR 1910.147 (see Safety Standards).
- Properly install, ground, and operate this equipment according to its Owner's Manual and national, state, and local codes.

- Always verify the supply ground – check and be sure that input power cord ground wire is properly connected to ground terminal in disconnect box or that cord plug is connected to a properly grounded receptacle outlet.
- When making input connections, attach proper grounding conductor first – double-check connections.
- Keep cords dry, free of oil and grease, and protected from hot metal and sparks.
- Frequently inspect input power cord and ground conductor for damage or bare wiring – replace immediately if damaged – bare wiring can kill.
- Turn off all equipment when not in use.
- Do not use worn, damaged, undersized, or repaired cables.
- Do not drape cables over your body.
- If earth grounding of the workpiece is required, ground it directly with a separate cable.
- Do not touch electrode if you are in contact with the work, ground, or another electrode from a different machine.
- Do not touch electrode holders connected to two welding machines at the same time since double open-circuit voltage will be present.
- Use only well-maintained equipment. Repair or replace damaged parts at once. Maintain unit according to manual.
- Wear a safety harness if working above floor level.
- Keep all panels and covers securely in place.
- Clamp work cable with good metal-to-metal contact to workpiece or worktable as near the weld as practical.
- Insulate work clamp when not connected to workpiece to prevent contact with any metal object.
- Do not connect more than one electrode or work cable to any single weld output terminal. Disconnect cable for process not in use.
- Use GFCI protection when operating auxiliary equipment in damp or wet locations.

### SIGNIFICANT DC VOLTAGE exists in inverter welding power sources AFTER removal of input power.

- Turn Off inverter, disconnect input power, and discharge input capacitors according to instructions in Maintenance Section before touching any parts.



### HOT PARTS can burn.

- Do not touch hot parts bare handed.
- Allow cooling period before working on equipment.
- To handle hot parts, use proper tools and/or wear heavy, insulated welding gloves and clothing to prevent burns.



### FUMES AND GASES can be hazardous.

Welding produces fumes and gases. Breathing these fumes and gases can be hazardous to your health.

- Keep your head out of the fumes. Do not breathe the fumes.
- If inside, ventilate the area and/or use local forced ventilation at the arc to remove welding fumes and gases. The recommended way to determine adequate ventilation is to sample for the composition and quantity of fumes and gases to which personnel are exposed.
- If ventilation is poor, wear an approved air-supplied respirator.
- Read and understand the Safety Data Sheets (SDSs) and the manufacturer's instructions for adhesives, coatings, cleaners, consumables, coolants, degreasers, fluxes, and metals.
- Work in a confined space only if it is well ventilated, or while wearing an air-supplied respirator. Always have a trained watchperson nearby. Welding fumes and gases can displace air and lower the oxygen level causing injury or death. Be sure the breathing air is safe.
- Do not weld in locations near degreasing, cleaning, or spraying operations. The heat and rays of the arc can react with vapors to form highly toxic and irritating gases.
- Do not weld on coated metals, such as galvanized, lead, or cadmium plated steel, unless the coating is removed from the weld area, the area is well ventilated, and while wearing an air-supplied respirator. The coatings and any metals containing these elements can give off toxic fumes if welded.



### ARC RAYS can burn eyes and skin.

Arc rays from the welding process produce intense visible and invisible (ultraviolet and infrared) rays that can burn eyes and skin. Sparks fly off from the weld.

- Wear an approved welding helmet fitted with a proper shade of filter lenses to protect your face and eyes from arc rays and sparks when welding or watching (see ANSI Z49.1 and Z87.1 listed in Safety Standards).
- Wear approved safety glasses with side shields under your helmet.
- Use protective screens or barriers to protect others from flash, glare and sparks; warn others not to watch the arc.
- Wear body protection made from durable, flame-resistant material (leather, heavy cotton, wool). Body protection includes oil-free clothing such as leather gloves, heavy shirt, cuffless trousers, high shoes, and a cap.



### WELDING can cause fire or explosion.

Welding on closed containers, such as tanks, drums, or pipes, can cause them to blow up. Sparks can fly off from the welding arc. The flying sparks, hot workpiece, and hot equipment can cause fires and burns. Accidental contact of electrode to metal objects can cause sparks, explosion, overheating, or fire. Check and be sure the area is safe before doing any welding.

- Remove all flammables within 35 ft (10.7 m) of the welding arc. If this is not possible, tightly cover them with approved covers.
- Do not weld where flying sparks can strike flammable material.
- Protect yourself and others from flying sparks and hot metal.
- Be alert that welding sparks and hot materials from welding can easily go through small cracks and openings to adjacent areas.
- Watch for fire, and keep a fire extinguisher nearby.
- Be aware that welding on a ceiling, floor, bulkhead, or partition can cause fire on the hidden side.
- Do not weld on containers that have held combustibles, or on closed containers such as tanks, drums, or pipes unless they are properly prepared according to AWS F4.1 and AWS A6.0 (see Safety Standards).
- Do not weld where the atmosphere can contain flammable dust, gas, or liquid vapors (such as gasoline).
- Connect work cable to the work as close to the welding area as practical to prevent welding current from traveling long, possibly unknown paths and causing electric shock, sparks, and fire hazards.
- Do not use welder to thaw frozen pipes.

- Remove stick electrode from holder or cut off welding wire at contact tip when not in use.
- Wear body protection made from durable, flame-resistant material (leather, heavy cotton, wool). Body protection includes oil-free clothing such as leather gloves, heavy shirt, cuffless trousers, high shoes, and a cap.
- Remove any combustibles, such as a butane lighter or matches, from your person before doing any welding.
- After completion of work, inspect area to ensure it is free of sparks, glowing embers, and flames.
- Use only correct fuses or circuit breakers. Do not oversize or bypass them.
- Follow requirements in OSHA 1910.252 (a) (2) (iv) and NFPA 51B for hot work and have a fire watcher and extinguisher nearby.
- Read and understand the Safety Data Sheets (SDSs) and the manufacturer's instructions for adhesives, coatings, cleaners, consumables, coolants, degreasers, fluxes, and metals.

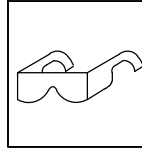

### FLYING METAL or DIRT can injure eyes.

- Welding, chipping, wire brushing, and grinding cause sparks and flying metal. As welds cool, they can throw off slag.
- Wear approved safety glasses with side shields even under your welding helmet.



### BUILDUP OF GAS can injure or kill.

- Shut off compressed gas supply when not in use.
- Always ventilate confined spaces or use approved air-supplied respirator.

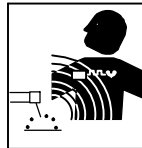

### ELECTRIC AND MAGNETIC FIELDS (EMF) can affect Implanted Medical Devices.

- Wearers of Pacemakers and other Implanted Medical Devices should keep away.
- Implanted Medical Device wearers should consult their doctor and the device manufacturer before going near arc welding, spot welding, gouging, plasma arc cutting, or induction heating operations.

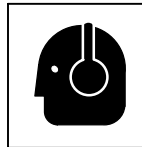

### NOISE can damage hearing.

Noise from some processes or equipment can damage hearing.

- Wear approved ear protection if noise level is high.

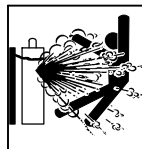

### CYLINDERS can explode if damaged.

Compressed gas cylinders contain gas under high pressure. If damaged, a cylinder can explode. Since gas cylinders are normally part of the welding process, be sure to treat them carefully.

- Protect compressed gas cylinders from excessive heat, mechanical shocks, physical damage, slag, open flames, sparks, and arcs.
- Install cylinders in an upright position by securing to a stationary support or cylinder rack to prevent falling or tipping.
- Keep cylinders away from any welding or other electrical circuits.
- Never drape a welding torch over a gas cylinder.
- Never allow a welding electrode to touch any cylinder.
- Never weld on a pressurized cylinder – explosion will result.
- Use only correct compressed gas cylinders, regulators, hoses, and fittings designed for the specific application; maintain them and associated parts in good condition.
- Turn face away from valve outlet when opening cylinder valve. Do not stand in front of or behind the regulator when opening the valve.
- Keep protective cap in place over valve except when cylinder is in use or connected for use.
- Use the right equipment, correct procedures, and sufficient number of persons to lift and move cylinders.
- Read and follow instructions on compressed gas cylinders, associated equipment, and Compressed Gas Association (CGA) publication P-1 listed in Safety Standards.



## 1-3. Additional Symbols For Installation, Operation, And Maintenance



### FIRE OR EXPLOSION hazard.

- Do not install or place unit on, over, or near combustible surfaces.
- Do not install unit near flammables.
- Do not overload building wiring – be sure power supply system is properly sized, rated, and protected to handle this unit.



### FALLING EQUIPMENT can injure.

- Use lifting eye to lift unit only, NOT running gear, gas cylinders, or any other accessories.
- Use equipment of adequate capacity to lift and support unit.
- If using lift forks to move unit, be sure forks are long enough to extend beyond opposite side of unit.
- Keep equipment (cables and cords) away from moving vehicles when working from an aerial location.
- Follow the guidelines in the Applications Manual for the Revised NIOSH Lifting Equation (Publication No. 94–110) when manually lifting heavy parts or equipment.

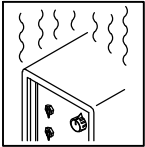

### OVERUSE can cause OVERHEATING

- Allow cooling period; follow rated duty cycle.
- Reduce current or reduce duty cycle before starting to weld again.
- Do not block or filter airflow to unit.

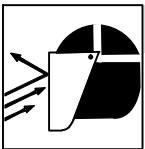

### FLYING SPARKS can injure.

- Wear a face shield to protect eyes and face.
- Shape tungsten electrode only on grinder with proper guards in a safe location wearing proper face, hand, and body protection.
- Sparks can cause fires — keep flammables away.



### STATIC (ESD) can damage PC boards.

- Put on grounded wrist strap BEFORE handling boards or parts.
- Use proper static-proof bags and boxes to store, move, or ship PC boards.



### MOVING PARTS can injure.

- Keep away from moving parts.
- Keep away from pinch points such as drive rolls.



### WELDING WIRE can injure.

- Do not press gun trigger until instructed to do so.
- Do not point gun toward any part of the body, other people, or any metal when threading welding wire.

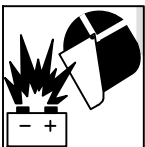

### BATTERY EXPLOSION can injure.

- Do not use welder to charge batteries or jump start vehicles unless it has a battery charging feature designed for this purpose.



### MOVING PARTS can injure.

- Keep away from moving parts such as fans.
- Keep all doors, panels, covers, and guards closed and securely in place.
- Have only qualified persons remove doors, panels, covers, or guards for maintenance and troubleshooting as necessary.
- Reinstall doors, panels, covers, or guards when maintenance is finished and before reconnecting input power.

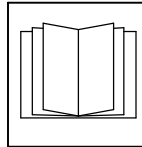

### READ INSTRUCTIONS.

- Read and follow all labels and the Owner's Manual carefully before installing, operating, or servicing unit. Read the safety information at the beginning of the manual and in each section.
- Use only genuine replacement parts from the manufacturer.
- Perform installation, maintenance, and service according to the Owner's Manuals, industry standards, and national, state, and local codes.

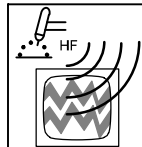

### H.F. RADIATION can cause interference.

- High-frequency (H.F.) can interfere with radio navigation, safety services, computers, and communications equipment.
- Have only qualified persons familiar with electronic equipment perform this installation.
- The user is responsible for having a qualified electrician promptly correct any interference problem resulting from the installation.
- If notified by the FCC about interference, stop using the equipment at once.
- Have the installation regularly checked and maintained.
- Keep high-frequency source doors and panels tightly shut, keep spark gaps at correct setting, and use grounding and shielding to minimize the possibility of interference.

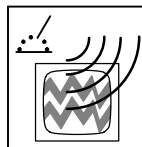

### ARC WELDING can cause interference.

- Electromagnetic energy can interfere with sensitive electronic equipment such as computers and computer-driven equipment such as robots.
- Be sure all equipment in the welding area is electromagnetically compatible.
- To reduce possible interference, keep weld cables as short as possible, close together, and down low, such as on the floor.
- Locate welding operation 100 meters from any sensitive electronic equipment.
- Be sure this welding machine is installed and grounded according to this manual.
- If interference still occurs, the user must take extra measures such as moving the welding machine, using shielded cables, using line filters, or shielding the work area.

## 1-4. California Proposition 65 Warnings

 **Welding or cutting equipment produces fumes or gases which contain chemicals known to the State of California to cause birth defects and, in some cases, cancer. (California Health & Safety Code Section 25249.5 et seq.)**

 **This product contains chemicals, including lead, known to the state of California to cause cancer, birth defects, or other reproductive harm. *Wash hands after use.***

## 1-5. Principal Safety Standards

*Safety in Welding, Cutting, and Allied Processes*, ANSI Standard Z49.1, is available as a free download from the American Welding Society at <http://www.aws.org> or purchased from Global Engineering Documents (phone: 1-877-413-5184, website: [www.global.ihs.com](http://www.global.ihs.com)).

*Safe Practices for the Preparation of Containers and Piping for Welding and Cutting*, American Welding Society Standard AWS F4.1, from Global Engineering Documents (phone: 1-877-413-5184, website: [www.global.ihs.com](http://www.global.ihs.com)).

*Safe Practices for Welding and Cutting Containers that have Held Combustibles*, American Welding Society Standard AWS A6.0, from Global Engineering Documents (phone: 1-877-413-5184, website: [www.global.ihs.com](http://www.global.ihs.com)).

*National Electrical Code*, NFPA Standard 70, from National Fire Protection Association, Quincy, MA 02269 (phone: 1-800-344-3555, website: [www.nfpa.org](http://www.nfpa.org) and [www.sparky.org](http://www.sparky.org)).

*Safe Handling of Compressed Gases in Cylinders*, CGA Pamphlet P-1, from Compressed Gas Association, 14501 George Carter Way, Suite 103, Chantilly, VA 20151 (phone: 703-788-2700, website: [www.cga-net.com](http://www.cga-net.com)).

*Safety in Welding, Cutting, and Allied Processes*, CSA Standard W117.2, from Canadian Standards Association, Standards Sales, 5060 Spectrum Way, Suite 100, Mississauga, Ontario, Canada L4W 5N5 (phone: 800-463-6727, website: [www.csagroup.org](http://www.csagroup.org)).

*Safe Practice For Occupational And Educational Eye And Face Protection*, ANSI Standard Z87.1, from American National Standards Institute, 25 West 43rd Street, New York, NY 10036 (phone: 212-642-4900, website: [www.ansi.org](http://www.ansi.org)).

*Standard for Fire Prevention During Welding, Cutting, and Other Hot Work*, NFPA Standard 51B, from National Fire Protection Association, Quincy, MA 02269 (phone: 1-800-344-3555, website: [www.nfpa.org](http://www.nfpa.org)).

OSHA, Occupational Safety and Health Standards for General Industry, Title 29, Code of Federal Regulations (CFR), Part 1910, Subpart Q, and Part 1926, Subpart J, from U.S. Government Printing Office, Superintendent of Documents, P.O. Box 371954, Pittsburgh, PA 15250-7954 (phone: 1-866-512-1800) (there are 10 OSHA Regional Offices—phone for Region 5, Chicago, is 312-353-2220, website: [www.osha.gov](http://www.osha.gov)).

*Applications Manual for the Revised NIOSH Lifting Equation*, The National Institute for Occupational Safety and Health (NIOSH), 1600 Clifton Rd, Atlanta, GA 30329-4027 (phone: 1-800-232-4636, website: [www.cdc.gov/NIOSH](http://www.cdc.gov/NIOSH)).

## 1-6. EMF Information

Electric current flowing through any conductor causes localized electric and magnetic fields (EMF). The current from arc welding (and allied processes including spot welding, gouging, plasma arc cutting, and induction heating operations) creates an EMF field around the welding circuit. EMF fields can interfere with some medical implants, e.g. pacemakers. Protective measures for persons wearing medical implants have to be taken. For example, restrict access for passers-by or conduct individual risk assessment for welders. All welders should use the following procedures in order to minimize exposure to EMF fields from the welding circuit:

1. Keep cables close together by twisting or taping them, or using a cable cover.
2. Do not place your body between welding cables. Arrange cables to one side and away from the operator.
3. Do not coil or drape cables around your body.

4. Keep head and trunk as far away from the equipment in the welding circuit as possible.
5. Connect work clamp to workpiece as close to the weld as possible.
6. Do not work next to, sit or lean on the welding power source.
7. Do not weld whilst carrying the welding power source or wire feeder.

### About Implanted Medical Devices:

Implanted Medical Device wearers should consult their doctor and the device manufacturer before performing or going near arc welding, spot welding, gouging, plasma arc cutting, or induction heating operations. If cleared by your doctor, then following the above procedures is recommended.

# SECTION 2 – CONSIGNES DE SÉCURITÉ – LIRE AVANT UTILISATION

fre\_som\_2015-09

**⚠** Pour écarter les risques de blessure pour vous-même et pour autrui — lire, appliquer et ranger en lieu sûr ces consignes relatives aux précautions de sécurité et au mode opératoire.

## 2-1. Symboles utilisés



**DANGER!** – Indique une situation dangereuse qui si on l'évite pas peut donner la mort ou des blessures graves. Les dangers possibles sont montrés par les symboles joints ou sont expliqués dans le texte.



Indique une situation dangereuse qui si on l'évite pas peut donner la mort ou des blessures graves. Les dangers possibles sont montrés par les symboles joints ou sont expliqués dans le texte.

**AVIS** – Indique des déclarations pas en relation avec des blessures personnelles.

 Indique des instructions spécifiques.



Ce groupe de symboles veut dire Avertissement! Attention! DANGER DE CHOC ELECTRIQUE, PIECES EN MOUVEMENT, et PIECES CHAUDES. Consulter les symboles et les instructions ci-dessous y afférant pour les actions nécessaires afin d'éviter le danger.

## 2-2. Dangers relatifs au soudage à l'arc



Les symboles représentés ci-dessous sont utilisés dans ce manuel pour attirer l'attention et identifier les dangers possibles. En présence de l'un de ces symboles, prendre garde et suivre les instructions afférentes pour éviter tout risque. Les instructions en matière de sécurité indiquées ci-dessous ne constituent qu'un sommaire des instructions de sécurité plus complètes fournies dans les normes de sécurité énumérées dans la Section 2-5. Lire et observer toutes les normes de sécurité.



Seul un personnel qualifié est autorisé à installer, faire fonctionner, entretenir et réparer cet appareil.



Pendant le fonctionnement, maintenir à distance toutes les personnes, notamment les enfants de l'appareil.



### UNE DÉCHARGE ÉLECTRIQUE peut entraîner la mort.

Le contact d'organes électriques sous tension peut provoquer des accidents mortels ou des brûlures graves. Le circuit de l'électrode et de la pièce est sous tension lorsque le courant est délivré à la sortie. Le circuit d'alimentation et les circuits internes de la machine sont également sous tension lorsque l'alimentation est sur Marche. Dans le mode de soudage avec du fil, le fil, le dérouleur, le bloc de commande du rouleau et toutes les parties métalliques en contact avec le fil sont sous tension électrique. Un équipement installé ou mis à la terre de manière incorrecte ou impropre constitue un danger.

- Ne pas toucher aux pièces électriques sous tension.
- Porter des gants isolants et des vêtements de protection secs et sans trous.
- S'isoler de la pièce à couper et du sol en utilisant des housses ou des tapis assez grands afin d'éviter tout contact physique avec la pièce à couper ou le sol.
- Ne pas se servir de source électrique à courant électrique dans les zones humides, dans les endroits confinés ou là où on risque de tomber.
- Se servir d'une source électrique à courant électrique UNIQUEMENT si le procédé de soudage le demande.
- Si l'utilisation d'une source électrique à courant électrique s'avère nécessaire, se servir de la fonction de télécommande si l'appareil en est équipé.
- D'autres consignes de sécurité sont nécessaires dans les conditions suivantes : risques électriques dans un environnement humide ou si l'on porte des vêtements mouillés ; sur des structures métalliques telles que sols, grilles ou échafaudages ; en position coincée comme assise, à genoux ou couchée ; ou s'il y a un risque élevé de contact inévitable ou accidentel avec la pièce à souder ou le sol. Dans ces conditions, utiliser les équipements suivants, dans l'ordre indiqué : 1) un poste à souder DC à tension constante (à fil), 2) un poste à souder DC manuel (électrode) ou 3) un poste à souder AC à tension à vide réduite. Dans la plupart des situations, l'utilisation d'un poste à souder DC à fil à tension constante est recommandée. En outre, ne pas travailler seul !

- Couper l'alimentation ou arrêter le moteur avant de procéder à l'installation, à la réparation ou à l'entretien de l'appareil. Déverrouiller l'alimentation selon la norme OSHA 29 CFR 1910.147 (voir normes de sécurité).
- Installez, mettez à la terre et utilisez correctement cet équipement conformément à son Manuel d'Utilisation et aux réglementations nationales, gouvernementales et locales.
- Toujours vérifier la terre du cordon d'alimentation. Vérifier et s'assurer que le fil de terre du cordon d'alimentation est bien raccordé à la borne de terre du sectionneur ou que la fiche du cordon est raccordée à une prise correctement mise à la terre.
- En effectuant les raccordements d'entrée, fixer d'abord le conducteur de mise à la terre approprié et contre-vérifier les connexions.
- Les câbles doivent être exempts d'humidité, d'huile et de graisse; protégez-les contre les étincelles et les pièces métalliques chaudes.
- Vérifier fréquemment le cordon d'alimentation et le conducteur de mise à la terre afin de s'assurer qu'il n'est pas altéré ou dénudé –, le remplacer immédiatement s'il l'est –. Un fil dénudé peut entraîner la mort.
- L'équipement doit être hors tension lorsqu'il n'est pas utilisé.
- Ne pas utiliser des câbles usés, endommagés, de grosseur insuffisante ou mal épissés.
- Ne pas enrouler les câbles autour du corps.
- Si la pièce soudée doit être mise à la terre, le faire directement avec un câble distinct.
- Ne pas toucher l'électrode quand on est en contact avec la pièce, la terre ou une électrode provenant d'une autre machine.
- Ne pas toucher des porte électrodes connectés à deux machines en même temps à cause de la présence d'une tension à vide doublée.
- N'utiliser qu'un matériel en bon état. Réparer ou remplacer sur-le-champ les pièces endommagées. Entretien l'appareil conformément à ce manuel.
- Porter un harnais de sécurité si l'on doit travailler au-dessus du sol.
- S'assurer que tous les panneaux et couvercles sont correctement en place.
- Fixer le câble de retour de façon à obtenir un bon contact métal-métal avec la pièce à souder ou la table de travail, le plus près possible de la soudure.
- Isoler la pince de masse quand pas mis à la pièce pour éviter le contact avec tout objet métallique.
- Ne pas raccorder plus d'une électrode ou plus d'un câble de masse à une même borne de sortie de soudage. Débrancher le câble pour le procédé non utilisé.
- Utiliser une protection différentielle lors de l'utilisation d'un équipement auxiliaire dans des endroits humides ou mouillés.

### Il reste une TENSION DC NON NÉGLIGEABLE dans les sources de soudage onduleur UNE FOIS l'alimentation coupée.

- Arrêter les convertisseurs, débrancher le courant électrique et décharger les condensateurs d'alimentation selon les instructions indiquées dans la partie Entretien avant de toucher les pièces.



### LES PIÈCES CHAUDES peuvent provoquer des brûlures.

- Ne pas toucher à mains nues les parties chaudes.
- Prévoir une période de refroidissement avant de travailler à l'équipement.

- Ne pas toucher aux pièces chaudes, utiliser les outils recommandés et porter des gants de soudage et des vêtements épais pour éviter les brûlures.

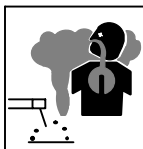

### LES FUMÉES ET LES GAZ peuvent être dangereux.

Le soudage génère des fumées et des gaz. Leur inhalation peut être dangereux pour votre santé.

- Eloigner votre tête des fumées. Ne pas respirer les fumées.
- À l'intérieur, ventiler la zone et/ou utiliser une ventilation forcée au niveau de l'arc pour l'évacuation des fumées et des gaz de soudage. Pour déterminer la bonne ventilation, il est recommandé de procéder à un prélèvement pour la composition et la quantité de fumées et de gaz auxquels est exposé le personnel.
- Si la ventilation est médiocre, porter un respirateur anti-vapeurs approuvé.
- Lire et comprendre les fiches de données de sécurité et les instructions du fabricant concernant les adhésifs, les revêtements, les nettoyants, les consommables, les produits de refroidissement, les dégraissateurs, les flux et les métaux.
- Travailler dans un espace fermé seulement s'il est bien ventilé ou en portant un respirateur à alimentation d'air. Demander toujours à un surveillant dûment formé de se tenir à proximité. Des fumées et des gaz de soudage peuvent déplacer l'air et abaisser le niveau d'oxygène provoquant des blessures ou des accidents mortels. S'assurer que l'air de respiration ne présente aucun danger.
- Ne pas souder dans des endroits situés à proximité d'opérations de dégraissage, de nettoyage ou de pulvérisation. La chaleur et les rayons de l'arc peuvent réagir en présence de vapeurs et former des gaz hautement toxiques et irritants.
- Ne pas souder des métaux munis d'un revêtement, tels que l'acier galvanisé, plaqué en plomb ou au cadmium à moins que le revêtement n'ait été enlevé dans la zone de soudure, que l'endroit soit bien ventilé, et en portant un respirateur à alimentation d'air. Les revêtements et tous les métaux renfermant ces éléments peuvent dégager des fumées toxiques en cas de soudage.



### LES RAYONS DE L'ARC peuvent provoquer des brûlures dans les yeux et sur la peau.

Le rayonnement de l'arc du procédé de soudage génère des rayons visibles et invisibles intenses (ultraviolets et infrarouges) susceptibles de provoquer des brûlures dans les yeux et sur la peau. Des étincelles sont projetées pendant le soudage.

- Porter un casque de soudage approuvé muni de verres filtrants approprié pour protéger visage et yeux pour protéger votre visage et vos yeux pendant le soudage ou pour regarder (voir ANSI Z49.1 et Z87.1 énuméré dans les normes de sécurité).
- Porter des lunettes de sécurité avec écrans latéraux même sous votre casque.
- Avoir recours à des écrans protecteurs ou à des rideaux pour protéger les autres contre les rayonnements les éblouissements et les étincelles ; prévenir toute personne sur les lieux de ne pas regarder l'arc.
- Porter un équipement de protection pour le corps fait d'un matériau résistant et ignifuge (cuir, coton robuste, laine). La protection du corps comporte des vêtements sans huile comme par ex. des gants de cuir, une chemise solide, des pantalons sans revers, des chaussures hautes et une casquette.

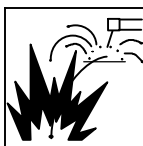

### LE SOUDAGE peut provoquer un incendie ou une explosion.

Le soudage effectué sur des conteneurs fermés tels que des réservoirs, tambours ou des conduites peut provoquer leur éclatement. Des étincelles peuvent être projetées de l'arc de soudure. La projection d'étincelles, des pièces chaudes et des équipements chauds peut provoquer des incendies et des brûlures. Le contact accidentel de l'électrode avec des objets métalliques peut provoquer des étincelles, une explosion, un sur-

chauffement ou un incendie. Avant de commencer le soudage, vérifier et s'assurer que l'endroit ne présente pas de danger.

- Déplacer toutes les substances inflammables à une distance de 10,7 m de l'arc de soudage. En cas d'impossibilité les recouvrir soigneusement avec des protections homologués.
- Ne pas souder dans un endroit où des étincelles peuvent tomber sur des substances inflammables.
- Se protéger et d'autres personnes de la projection d'étincelles et de métal chaud.
- Des étincelles et des matériaux chauds du soudage peuvent facilement passer dans d'autres zones en traversant de petites fissures et des ouvertures.
- Surveiller tout déclenchement d'incendie et tenir un extincteur à proximité.
- Le soudage effectué sur un plafond, plancher, paroi ou séparation peut déclencher un incendie de l'autre côté.
- Ne pas effectuer le soudage sur des conteneurs fermés tels que des réservoirs, tambours, ou conduites, à moins qu'ils n'aient été préparés correctement conformément à AWS F4.1 et AWS A6.0 (voir les Normes de Sécurité).
- Ne pas souder là où l'air ambiant pourrait contenir des poussières, gaz ou émanations inflammables (vapeur d'essence, par exemple).
- Brancher le câble de masse sur la pièce la plus près possible de la zone de soudage pour éviter le transport du courant sur une longue distance par des chemins inconnus éventuels en provoquant des risques d'électrocution, d'étincelles et d'incendie.
- Ne pas utiliser le poste de soudage pour dégeler des conduites gelées.
- En cas de non utilisation, enlever la baguette d'électrode du porte-électrode ou couper le fil à la pointe de contact.
- Porter un équipement de protection pour le corps fait d'un matériau résistant et ignifuge (cuir, coton robuste, laine). La protection du corps comporte des vêtements sans huile comme par ex. des gants de cuir, une chemise solide, des pantalons sans revers, des chaussures hautes et une casquette.
- Avant de souder, retirer toute substance combustible de vos poches telles qu'un allumeur au butane ou des allumettes.
- Une fois le travail achevé, assurez-vous qu'il ne reste aucune trace d'étincelles incandescentes ni de flammes.
- Utiliser exclusivement des fusibles ou coupe-circuits appropriés. Ne pas augmenter leur puissance; ne pas les ponter.
- Suivre les recommandations dans OSHA 1910.252(a)(2)(iv) et NFPA 51B pour les travaux à chaud et avoir de la surveillance et un extincteur à proximité.
- Lire et comprendre les fiches de données de sécurité et les instructions du fabricant concernant les adhésifs, les revêtements, les nettoyants, les consommables, les produits de refroidissement, les dégraissateurs, les flux et les métaux.

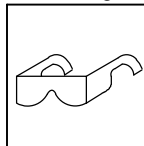

### DES PIÈCES DE METAL ou DES SALETES peuvent provoquer des blessures dans les yeux.

- Le soudage, l'écaillage, le passage de la pièce à la brosse en fil de fer, et le meulage génèrent des étincelles et des particules métalliques volantes. Pendant la période de refroidissement des soudures, elles risquent de projeter du laitier.
- Porter des lunettes de sécurité avec écrans latéraux ou un écran facial.



### LES ACCUMULATIONS DE GAZ risquent de provoquer des blessures ou même la mort.

- Fermer l'alimentation du gaz comprimé en cas de non utilisation.
- Veiller toujours à bien aérer les espaces confinés ou se servir d'un respirateur d'adduction d'air homologué.

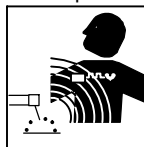

### Les CHAMPS ÉLECTROMAGNÉTIQUES (CEM) peuvent affecter les implants médicaux.

- Les porteurs de stimulateurs cardiaques et autres implants médicaux doivent rester à distance.
- Les porteurs d'implants médicaux doivent consulter leur médecin et le fabricant du dispositif avant de s'approcher de la zone où se déroule du soudage à l'arc, du soudage par points, du gougeage, de la découpe plasma ou une opération de chauffage par induction.

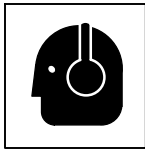

### LE BRUIT peut endommager l'ouïe.

Le bruit des processus et des équipements peut affecter l'ouïe.

- Porter des protections approuvées pour les oreilles si le niveau sonore est trop élevé.

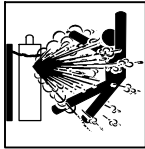

### LES BOUTEILLES peuvent exploser si elles sont endommagées.

Les bouteilles de gaz comprimé contiennent du gaz sous haute pression. Si une bouteille est endommagée, elle peut exploser. Du fait que

les bouteilles de gaz font normalement partie du procédé de soudage, les manipuler avec précaution.

- Protéger les bouteilles de gaz comprimé d'une chaleur excessive, des chocs mécaniques, des dommages physiques, du laitier, des flammes ouvertes, des étincelles et des arcs.
- Placer les bouteilles debout en les fixant dans un support stationnaire ou dans un porte-bouteilles pour les empêcher de tomber ou de se renverser.

## 2-3. Dangers supplémentaires en relation avec l'installation, le fonctionnement et la maintenance



### Risque D'INCENDIE OU D'EXPLOSION.

- Ne pas placer l'appareil sur, au-dessus ou à proximité de surfaces inflammables.
- Ne pas installer l'appareil à proximité de produits inflammables.
- Ne pas surcharger l'installation électrique – s'assurer que l'alimentation est correctement dimensionnée et protégée avant de mettre l'appareil en service.



### LA CHUTE DE L'ÉQUIPEMENT peut provoquer des blessures.

- Utiliser l'anneau de levage uniquement pour soulever l'appareil, NON PAS les chariots, les bouteilles de gaz ou tout autre accessoire.
- Utiliser un équipement de levage de capacité suffisante pour lever l'appareil.
- En utilisant des fourches de levage pour déplacer l'unité, s'assurer que les fourches sont suffisamment longues pour dépasser du côté opposé de l'appareil.
- Tenir l'équipement (câbles et cordons) à distance des véhicules mobiles lors de toute opération en hauteur.
- Suivre les consignes du Manuel des applications pour l'équation de levage NIOSH révisée (Publication N°94-110) lors du levage manuel de pièces ou équipements lourds.

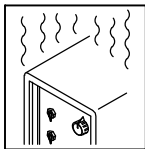

### L'EMPLOI EXCESSIF peut SURCHAUFFER L'ÉQUIPEMENT.

- Prévoir une période de refroidissement ; respecter le cycle opératoire nominal.
- Réduire le courant ou le facteur de marche avant de poursuivre le soudage.
- Ne pas obstruer les passages d'air du poste.

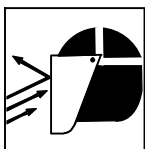

### LES ÉTINCELLES PROJÉTÉES peuvent provoquer des blessures.

- Porter un écran facial pour protéger le visage et les yeux.
- Affûter l'électrode au tungstène uniquement à la meuleuse dotée de protecteurs. Cette manœuvre est à exécuter dans un endroit sûr lorsque l'on porte l'équipement homologué de protection du visage, des mains et du corps.
- Les étincelles risquent de causer un incendie – éloigner toute substance inflammable.

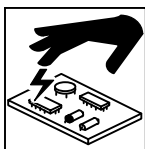

### LES CHARGES ÉLECTROSTATIQUES peuvent endommager les circuits imprimés.

- Établir la connexion avec la barrette de terre avant de manipuler des cartes ou des pièces.

- Tenir les bouteilles éloignées des circuits de soudage ou autres circuits électriques.
- Ne jamais placer une torche de soudage sur une bouteille à gaz.
- Une électrode de soudage ne doit jamais entrer en contact avec une bouteille.
- Ne jamais souder une bouteille pressurisée – risque d'explosion.
- Utiliser seulement des bouteilles de gaz comprimé, régulateurs, tuyaux et raccords convenables pour cette application spécifique; les maintenir ainsi que les éléments associés en bon état.
- Tourner le dos à la sortie de vanne lors de l'ouverture de la vanne de la bouteille. Ne pas se tenir devant ou derrière le régulateur lors de l'ouverture de la vanne.
- Le couvercle du détendeur doit toujours être en place, sauf lorsque la bouteille est utilisée ou qu'elle est reliée pour usage ultérieur.
- Utiliser les équipements corrects, les bonnes procédures et suffisamment de personnes pour soulever et déplacer les bouteilles.
- Lire et suivre les instructions sur les bouteilles de gaz comprimé, l'équipement connexe et le dépliant P-1 de la CGA (Compressed Gas Association) mentionné dans les principales normes de sécurité.

- Utiliser des pochettes et des boîtes antistatiques pour stocker, déplacer ou expédier des cartes de circuits imprimés.

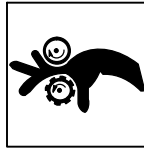

### Les PIÈCES MOBILES peuvent causer des blessures.

- Ne pas s'approcher des organes mobiles.
- Ne pas s'approcher des points de coincement tels que des rouleaux de commande.



### LES FILS DE SOUDAGE peuvent provoquer des blessures.

- Ne pas appuyer sur la gâchette avant d'en avoir reçu l'instruction.
- Ne pas diriger le pistolet vers soi, d'autres

personnes ou toute pièce mécanique en engageant le fil de soudage.

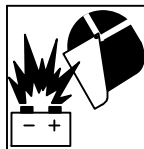

### L'EXPLOSION DE LA BATTERIE peut provoquer des blessures.

- Ne pas utiliser l'appareil de soudage pour charger des batteries ou faire démarrer des véhicules à l'aide de câbles de démarrage, sauf si l'appareil dispose d'une fonctionnalité de charge de batterie destinée à cet usage.



### Les PIÈCES MOBILES peuvent causer des blessures.

- S'abstenir de toucher des organes mobiles tels que des ventilateurs.
- Maintenir fermés et verrouillés les portes,

panneaux, recouvrements et dispositifs de protection.

- Lorsque cela est nécessaire pour des travaux d'entretien et de dépannage, faire retirer les portes, panneaux, recouvrements ou dispositifs de protection uniquement par du personnel qualifié.
- Remettre les portes, panneaux, recouvrements ou dispositifs de protection quand l'entretien est terminé et avant de rebrancher l'alimentation électrique.

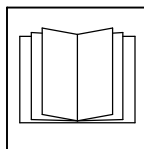

### LIRE LES INSTRUCTIONS.

- Lire et appliquer les instructions sur les étiquettes et le Mode d'emploi avant l'installation, l'utilisation ou l'entretien de l'appareil. Lire les informations de sécurité au début du manuel et dans chaque section.

- N'utiliser que les pièces de rechange recommandées par le constructeur.
- Effectuer l'installation, l'entretien et toute intervention selon les manuels d'utilisateurs, les normes nationales, provinciales et de l'industrie, ainsi que les codes municipaux.



## LE RAYONNEMENT HAUTE FRÉQUENCE (H.F.) risque de provoquer des interférences.

- Le rayonnement haute fréquence (H.F.) peut provoquer des interférences avec les équipements de radio-navigation et de communication, les services de sécurité et les ordinateurs.
- Demander seulement à des personnes qualifiées familiarisées avec des équipements électroniques de faire fonctionner l'installation.
- L'utilisateur est tenu de faire corriger rapidement par un électricien qualifié les interférences résultant de l'installation.
- Si le FCC signale des interférences, arrêter immédiatement l'appareil.
- Effectuer régulièrement le contrôle et l'entretien de l'installation.
- Maintenir soigneusement fermés les portes et les panneaux des sources de haute fréquence, maintenir les éclateurs à une distance correcte et utiliser une terre et un blindage pour réduire les interférences éventuelles.

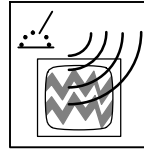

## LE SOUDAGE À L'ARC risque de provoquer des interférences.

- L'énergie électromagnétique risque de provoquer des interférences pour l'équipement électronique sensible tel que les ordinateurs et l'équipement commandé par ordinateur tel que les robots.
- Veiller à ce que tout l'équipement de la zone de soudage soit compatible électromagnétiquement.
- Pour réduire la possibilité d'interférence, maintenir les câbles de soudage aussi courts que possible, les grouper, et les poser aussi bas que possible (ex. par terre).
- Veiller à souder à une distance de 100 mètres de tout équipement électronique sensible.
- Veiller à ce que ce poste de soudage soit posé et mis à la terre conformément à ce mode d'emploi.
- En cas d'interférences après avoir pris les mesures précédentes, il incombe à l'utilisateur de prendre des mesures supplémentaires telles que le déplacement du poste, l'utilisation de câbles blindés, l'utilisation de filtres de ligne ou la pose de protecteurs dans la zone de travail.

## 2-4. Proposition californienne 65 Avertissements

**⚠ Les équipements de soudage et de coupage produisent des fumées et des gaz qui contiennent des produits chimiques dont l'État de Californie reconnaît qu'ils provoquent des malformations congénitales et, dans certains cas, des cancers. (Code de santé et de sécurité de Californie, chapitre 25249.5 et suivants)**

**⚠ Ce produit contient des produits chimiques, notamment du plomb, dont l'État de Californie reconnaît qu'ils provoquent des cancers, des malformations congénitales ou d'autres problèmes de procréation. Se laver les mains après utilisation.**

## 2-5. Principales normes de sécurité

*Safety in Welding, Cutting, and Allied Processes*, ANSI Standard Z49.1, is available as a free download from the American Welding Society at <http://www.aws.org> or purchased from Global Engineering Documents (phone: 1-877-413-5184, website: [www.global.ihs.com](http://www.global.ihs.com)).

*Safe Practices for the Preparation of Containers and Piping for Welding and Cutting*, American Welding Society Standard AWS F4.1, from Global Engineering Documents (phone: 1-877-413-5184, website: [www.global.ihs.com](http://www.global.ihs.com)).

*Safe Practices for Welding and Cutting Containers that have Held Combustibles*, American Welding Society Standard AWS A6.0, from Global Engineering Documents (phone: 1-877-413-5184, website: [www.global.ihs.com](http://www.global.ihs.com)).

*National Electrical Code*, NFPA Standard 70, from National Fire Protection Association, Quincy, MA 02269 (phone: 1-800-344-3555, website: [www.nfpa.org](http://www.nfpa.org) and [www.sparky.org](http://www.sparky.org)).

*Safe Handling of Compressed Gases in Cylinders*, CGA Pamphlet P-1, from Compressed Gas Association, 14501 George Carter Way, Suite 103, Chantilly, VA 20151 (phone: 703-788-2700, website: [www.cganet.com](http://www.cganet.com)).

*Safety in Welding, Cutting, and Allied Processes*, CSA Standard W117.2, from Canadian Standards Association, Standards Sales, 5060

Spectrum Way, Suite 100, Mississauga, Ontario, Canada L4W 5N5 (phone: 800-463-6727, website: [www.csagroup.org](http://www.csagroup.org)).

*Safe Practice For Occupational And Educational Eye And Face Protection*, ANSI Standard Z87.1, from American National Standards Institute, 25 West 43rd Street, New York, NY 10036 (phone: 212-642-4900, website: [www.ansi.org](http://www.ansi.org)).

*Standard for Fire Prevention During Welding, Cutting, and Other Hot Work*, NFPA Standard 51B, from National Fire Protection Association, Quincy, MA 02269 (phone: 1-800-344-3555, website: [www.nfpa.org](http://www.nfpa.org)).

OSHA, Occupational Safety and Health Standards for General Industry, Title 29, Code of Federal Regulations (CFR), Part 1910, Subpart Q, and Part 1926, Subpart J, from U.S. Government Printing Office, Superintendent of Documents, P.O. Box 371954, Pittsburgh, PA 15250-7954 (phone: 1-866-512-1800) (there are 10 OSHA Regional Offices—phone for Region 5, Chicago, is 312-353-2220, website: [www.osha.gov](http://www.osha.gov)).

*Applications Manual for the Revised NIOSH Lifting Equation*, The National Institute for Occupational Safety and Health (NIOSH), 1600 Clifton Rd, Atlanta, GA 30329-4027 (phone: 1-800-232-4636, website: [www.cdc.gov/NIOSH](http://www.cdc.gov/NIOSH)).

## 2-6. Informations relatives aux CEM

Le courant électrique qui traverse tout conducteur génère des champs électromagnétiques (CEM) à certains endroits. Le courant issu d'un soudage à l'arc (et de procédés connexes, y compris le soudage par points, le gougeage, le découpage plasma et les opérations de chauffage par induction) crée un champ électromagnétique (CEM) autour du circuit de soudage. Les champs électromagnétiques produits peuvent causer interférence à certains implants médicaux, p. ex. les stimulateurs cardiaques. Des mesures de protection pour les porteurs d'implants médicaux doivent être prises: Limiter par exemple tout accès aux passants ou procéder à une évaluation des risques individuels pour les soudeurs. Tous les soudeurs doivent appliquer les procédures suivantes pour minimiser l'exposition aux CEM provenant du circuit de soudage:

1. Rassembler les câbles en les torsadant ou en les attachant avec du ruban adhésif ou avec une housse.
2. Ne pas se tenir au milieu des câbles de soudage. Disposer les

câbles d'un côté et à distance de l'opérateur.

3. Ne pas courber et ne pas entourer les câbles autour de votre corps.
4. Maintenir la tête et le torse aussi loin que possible du matériel du circuit de soudage.
5. Connecter la pince sur la pièce aussi près que possible de la soudure.
6. Ne pas travailler à proximité d'une source de soudage, ni s'asseoir ou se pencher dessus.
7. Ne pas souder tout en portant la source de soudage ou le dévidoir.







### En ce qui concerne les implants médicaux :



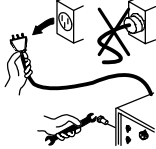
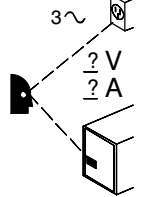
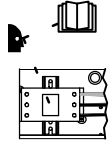

Les porteurs d'implants doivent d'abord consulter leur médecin avant de s'approcher des opérations de soudage à l'arc, de soudage par points, de gougeage, du coupage plasma ou de chauffage par induction. Si le médecin approuve, il est recommandé de suivre les procédures précédentes.

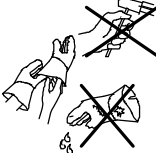
## SECTION 3 – DEFINITIONS

### 3-1. Additional Safety Symbols And Definitions

 Some symbols are found only on CE products.

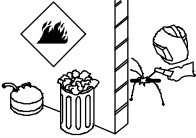
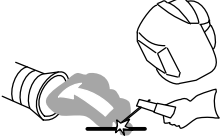
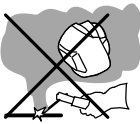

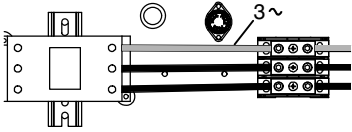
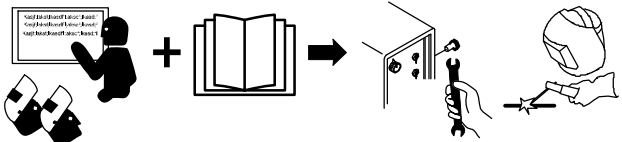
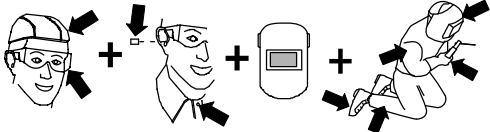
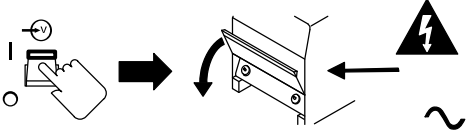
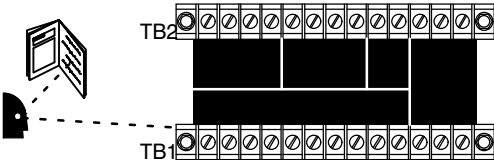





	<p>Warning! Watch Out! There are possible hazards as shown by the symbols.</p> <p style="text-align: right;">Safe1 2012-05</p>
	<p>Do not discard product (where applicable) with general waste. Reuse or recycle Waste Electrical and Electronic Equipment (WEEE) by disposing at a designated collection facility. Contact your local recycling office or your local distributor for further information.</p> <p style="text-align: right;">Safe37 2012-05</p>
	<p>Environmental Protection Use Period (China)</p> <p style="text-align: right;">Safe123 2016-06</p>
	<p>Disconnect input plug or power before working on machine.</p> <p style="text-align: right;">Safe5 2012-05</p>
	<p>Consult rating label for input power requirements.</p> <p style="text-align: right;">Safe34 2012-05</p>
	<p>Become trained and read the instructions before working on machine.</p> <p style="text-align: right;">Safe104 2012-09</p>
	<p>Connect green or green/yellow grounding conductor to ground terminal.</p> <p style="text-align: right;">Safe105 2012-09</p>
	<p>Recycle or dispose of used flux in an environmentally safe way.</p> <p style="text-align: right;">Safe103 2012-09</p>
	<p>Wear dry insulating gloves. Do not touch electrode with bare hand. Do not wear wet or damaged gloves.</p> <p style="text-align: right;">Safe2 2012-05</p>
	<p>Do not remove or paint over (cover) the label.</p> <p style="text-align: right;">Safe20 2012-05</p>



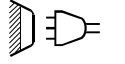

	<p>Do not weld on drums or any closed containers.</p> <p style="text-align: right;">Safe16 2012-05</p>
	<p>Welding sparks can cause fires. Have a fire extinguisher nearby, and have a watchperson ready to use it.</p> <p style="text-align: right;">Safe14 2012-05</p>
	<p>Keep flammables away from welding. Do not weld near flammables.</p> <p style="text-align: right;">Safe12 2012-05</p>
	<p>Use forced ventilation or local exhaust to remove the fumes.</p> <p style="text-align: right;">Safe8 2012-05</p>
	<p>Keep your head out of the fumes.</p> <p style="text-align: right;">Safe6 2012-05</p>
	<p>Protect yourself from electric shock by insulating yourself from work and ground.</p> <p style="text-align: right;">Safe3 2012-05</p>
	<p>Connect input conductors (L1, L2 And L3) to line terminals.</p> <p style="text-align: right;">Safe 106 2012-09</p>
	<p>Become trained and read the instructions before working on the machine or welding.</p> <p style="text-align: right;">Safe40 2012-05</p>
	<p>Wear hat and safety glasses. Use ear protection and button shirt collar. Use welding helmet with correct shade of filter. Wear complete body protection.</p> <p style="text-align: right;">Safe38 2012-05</p>
	<p>Turn power off before connecting to 115 volt receptacle.</p> <p style="text-align: right;">Safe 107 2012-09</p>
	<p>Read Owner's Manual for terminal strip connection information.</p> <p style="text-align: right;">Safe116 2014-02</p>









### 3-2. Miscellaneous Symbols And Definitions

Some symbols are found only on CE products.

<b>A</b>	Amperage
<b>V</b>	Voltage
<b>Hz</b>	Hertz
	Temperature
	Output
	Input
	Circuit Breaker Supplementary Protector
	Line Connection
<b>3</b> 	Three Phase
	Panel/Local
	Remote
<b>U<sub>0</sub></b>	Rated No-Load Voltage (OCV)
<b>U<sub>1</sub></b>	Primary Voltage
<b>U<sub>2</sub></b>	Conventional Load Voltage

<b>I<sub>1</sub></b>	Primary Current
<b>I<sub>2</sub></b>	Rated Welding Current
<b>IP</b>	Degree Of Protection
<b>X</b>	Duty Cycle
<b>I</b>	On
<b>O</b>	Off
	Disturbance
	Alternating Current (AC)
	Submerged Arc Welding (SAW)
	Read Operator's Manual
<b>I<sub>1max</sub></b>	Rated Maximum Supply Current
<b>I<sub>1eff</sub></b>	Maximum Effective Supply Current
	Protective Earth (Ground)

	3-Phase Power Source With AC/DC Output
	Ventilating And Air Circulating Fan
	Increase/ Decrease
<b>—</b>	Negative Weld Output Terminal
<b>+</b>	Positive Weld Output Terminal
	Frame Or Chassis
<b>TE</b>	Terminal Strip
	Caution
	Work Connection
	Electrode Connection
<b>==</b>	Direct Current (DC)
<b>CC</b>	Constant Current
<b>CV</b>	Constant Voltage

## SECTION 4 – SPECIFICATIONS

### 4-1. Serial Number And Rating Label Location

The rating information for the power source is located on the the rear of the machine. Use the rating labels to determine input power requirements and/or rated output. The serial number is located on the rear of the machine, for future reference, write serial number in space provided on back cover of this manual.

### 4-2. Specifications

☞ Do not use information in unit specifications table to determine electrical service requirements. See Sections 5-4 and 5-5 for information on connecting input power.

Model	AC or DC Rated Output**	Amperage/Voltage Range AC/DC	Max. Open-Circuit Voltage	RMS Amps Input at Rated Output, 3-Phase at NEMA Load Voltages and Class 1 Rating			KVA	KW
				380V (50 Hz)	400V (50 Hz)	460V (60 Hz)		
SubArc AC/DC Digital, 1000 Amp	1000 A at 44 V, 100% Duty Cycle	300 – 1250 A in AC Mode	93 Vpk	—	—	122 (3*)	98 (2.37*)	53 (0.95*)
SubArc AC/DC 1250 Digital	1250 A at 44 V, 60% Duty Cycle	20 – 44 V in Subarc Mode		179 (3*)	176 (3*)	—	122 (2.37*)	67 (0.95*)

### 4-3. SubArc System Compatibility

The following accessory models will function with the SubArc AC/DC Digital Series power sources. The interface will automatically detect the power source and wire drive type connected.

**Interfaces:**

- 300936 – SubArc Interface Digital
- 300937 – SubArc Interface Analog

**Wire Drives:**

- 300938 – SubArc Wire Drive 400 Digital Low Voltage
- 300938001 – SubArc Wire Drive 400 Digital Low Voltage For Tractors
- 300939 – SubArc Strip Drive 100 Digital Low Voltage
- 300940 – SubArc Strip Drive 100 Digital Low Voltage w/Mounting Bracket
- 300941 – SubArc Wire Drive 780 Digital Low Voltage

**Flux Hopper:**

- 300942 – SubArc Flux Hopper Digital Low Voltage

### 4-4. Environmental Specifications

#### A. IP Rating For All Equipment Covered In This Manual

IP Rating	Operating Temperature Range	Storage Temperature Range
IP23  This equipment is designed for outdoor use. It may be stored, but is not intended to be used for welding outside during precipitation unless sheltered.	14 to 104 °F (–10 to 40°C)	–4 to 131 °F (–20 to 55°C) <span style="float: right;">IP23 2014–06</span>

## B. Information On Electromagnetic Compatibility (EMC) For Power Sources Covered In This Manual



This Class A equipment is not intended for use in residential locations where the electrical power is provided by the public low-voltage supply system. There can be potential difficulties in ensuring electromagnetic compatibility in those locations, due to conducted as well as radiated disturbances.



IEC/TS 61000-3-4 can be used to guide parties concerned by the installation of arc welding equipment with an input current greater than 75 A in a low-voltage network.

ce-emc 5 2014-07

## C. China EEP Hazardous Substance Information

中国电器电子产品中有毒物质的名称及含量 China EEP Hazardous Substance Information						
部件名称 Component Name (如果适用) (if applicable)	有害物质 Hazardous Substance					
	铅 Pb	汞 Hg	镉 Cd	六价铬 Cr6	多溴联苯 PBB	多溴二苯醚 PBDE
黄铜和铜部件 Brass and Copper Parts	X	O	O	O	O	O
耦合装置 Coupling Devices	X	O	O	O	O	O
开关装置 Switching Devices	O	O	X	O	O	O
线缆和线缆配件 Cable and Cable Accessories	X	O	O	O	O	O
电池 Batteries	X	O	O	O	O	O
本表格依据中国SJ/T 11364的规定编制。 This table is prepared in accordance with China SJ/T 11364.						
O: 表示该有害物质在该部件所有均质材料中的含量均在中国GB/T26572规定的限量要求以下。 Indicates that the concentration of the Hazardous Substance in all homogeneous materials of the part is below the relevant threshold of China GB/T 26572.						
X: 表示该有害物质至少在该部件的某一均质材料中的含量超出中国GB/T26572规定的限量要求。 Indicates that the concentration of the Hazardous Substance in at least one homogeneous material of the part is above the relevant threshold of China GB/T 26572.						
电器电子产品的环保使用期限依据中国SJ/Z11388的规定确定。 The EFUP value of this EEP is defined in accordance with China SJ/Z 11388.					EEP_2016-06	

## 4-5. Duty Cycle and Overheating

**100% Duty Cycle At 1000 Amperes**

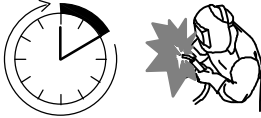

Continuous Welding

Duty Cycle is percentage of 10 minutes that unit can weld at rated load without overheating.

If unit overheats, high temperature shutdown light turns On, thermostat(s) opens, output stops, and cooling fan runs. Wait fifteen minutes for unit to cool. Reduce amperage or duty cycle before welding.

**NOTICE** – Exceeding duty cycle can damage unit and void warranty.

---

**Overheating**





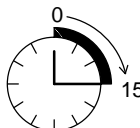



Minutes



OR



Reduce Duty Cycle



duty1 4/95 – 181 560

## 4-6. Static Characteristics

The static (output) characteristics of the welding power source can be described as *drooping* during the SAW process. Static characteristics are also affected by control settings (including software), electrode, shielding gas, weldment material, and other factors. Contact the factory for specific information on the static characteristics of the welding power source.

## SECTION 5 – INSTALLATION

### 5-1. Dimensions And Weight

Dimensions		<p style="text-align: center;"><b>Weight</b></p> <p>SubArc AC/DC Digital, 1000 Amp – 1187 lb (538 kg)                      SubArc AC/DC 1250 Digital – 1260 lb (567 kg)</p>
Height*	43 in. (1092 mm)	
Width*	27-1/2 in. (699 mm)	
Depth*	47-1/2 in. (1207 mm)	
A	1-7/8 in. (48 mm)	
B	42-1/4 in. (1073 mm)	
C	15/16 in. (24 mm)	
D	25-5/16 in. (643 mm)	
E	4 holes: 21/32 in. (6.5 mm) dia	

\* Includes lifting eye, handles, hardware, etc.

## 5-2. Selecting A Location



### Movement

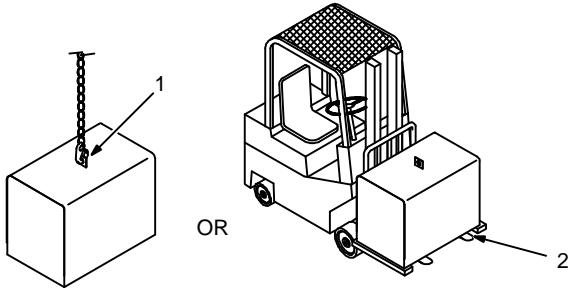

**⚠ Do not move or operate unit where it could tip.**

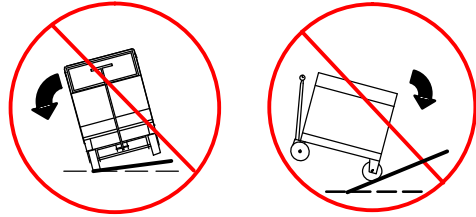

### Location And Airflow

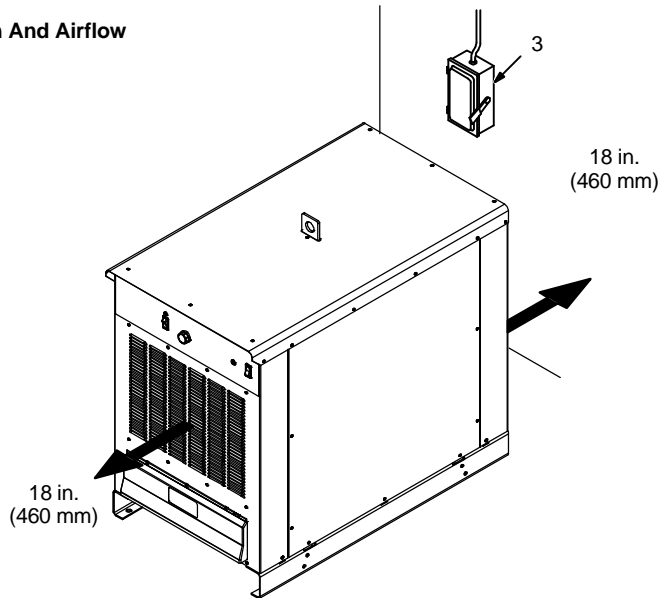

**⚠ Special installation may be required where gasoline or volatile liquids are present – see NEC Article 511 or CEC Section 20.**

- 1 Lifting Eye
- 2 Lifting Forks

Use lifting eye or lifting forks to move unit.

If using lifting forks, extend forks beyond opposite side of unit.

- 3 Line Disconnect Device

Locate unit near correct input power supply.

loc\_large 2015-04 / 265 690-A

## 5-3. Typical Equipment Location

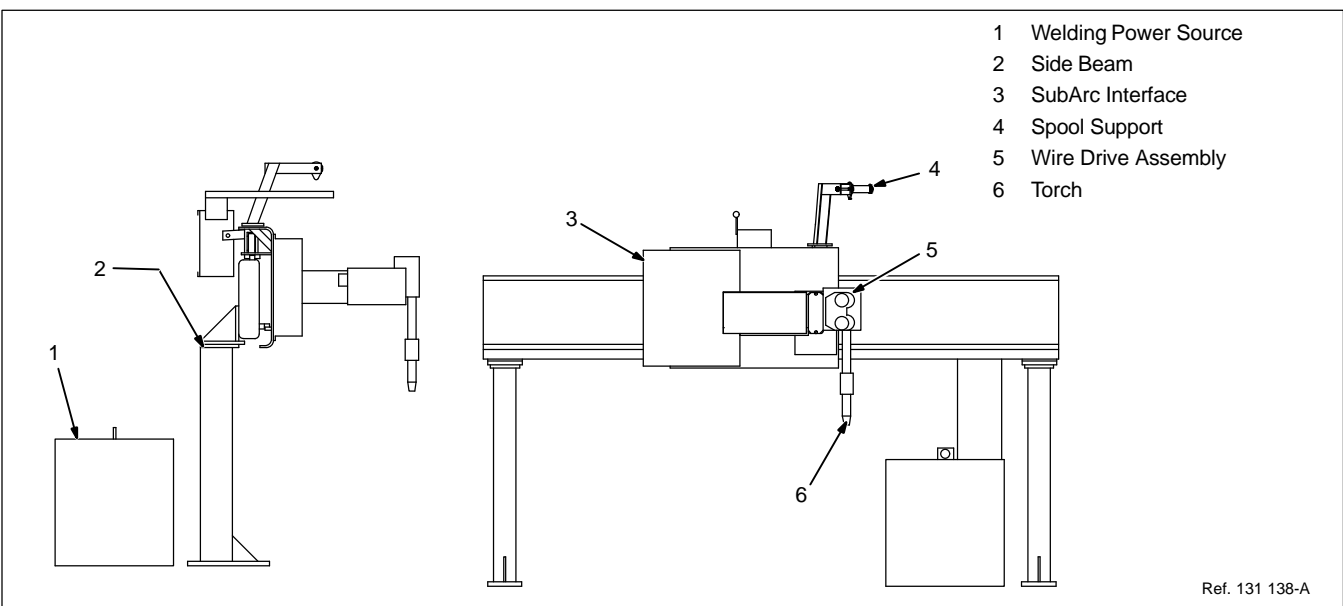

Ref. 131 138-A

## 5-4. Electrical Service Guide

### A. SubArc AC/DC Digital, 1000 Amp



Failure to follow these electrical service guide recommendations could create an electric shock or fire hazard. These recommendations are for a dedicated circuit sized for the rated output and duty cycle of the welding power source.

In dedicated circuit installations, the National Electrical Code (NEC) allows the receptacle or conductor rating to be less than the rating of the circuit protection device. All components of the circuit must be physically compatible. See NEC articles 210.21, 630.11, and 630.12.

	Three-Phase, 60 Hz
Input Voltage (V)	460
Input Amperes (A) At Rated Output	158
Max Recommended Standard Fuse Rating In Amperes <sup>1</sup>	
Time-Delay Fuses <sup>2</sup>	175
Normal Operating Fuses <sup>3</sup>	225
Min Input Conductor Size In AWG 4 (mm <sup>2</sup> )	1 (50)
Max Recommended Input Conductor Length In Feet (Meters)	379 (115)
Min Grounding Conductor Size In AWG 4 (mm <sup>2</sup> )	4 (25)

Reference: 2014 National Electrical Code (NEC) (including article 630)

- 1 If a circuit breaker is used in place of a fuse, choose a circuit breaker with time-current curves comparable to the recommended fuse.
- 2 "Time-Delay" fuses are UL class "RK5" . See UL 248.
- 3 "Normal Operating" (general purpose - no intentional delay) fuses are UL class "K5" (up to and including 60 amps), and UL class "H" ( 65 amps and above).
- 4 Conductor data in this section specifies conductor size (excluding flexible cord or cable) between the panelboard and the equipment per NEC Table 310.15(B)(16). If a flexible cord or cable is used, minimum conductor size may increase. See NEC Table 400.5(A) for flexible cord and cable requirements.

### B. SubArc AC/DC 1250 Digital



Failure to follow these electrical service guide recommendations could create an electric shock or fire hazard. These recommendations are for a dedicated circuit sized for the rated output and duty cycle of the welding power source.

In dedicated circuit installations, the National Electrical Code (NEC) allows the receptacle or conductor rating to be less than the rating of the circuit protection device. All components of the circuit must be physically compatible. See NEC articles 210.21, 630.11, and 630.12.

	Three-Phase, 50 Hz	
Input Voltage (V)	380	400
Input Amperes (A) At Rated Output	179	176
Max Recommended Standard Fuse Rating In Amperes <sup>1</sup>		
Time-Delay Fuses <sup>2</sup>	200	200
Normal Operating Fuses <sup>3</sup>	250	250
Min Input Conductor Size In AWG 4 (mm <sup>2</sup> )	1/0 (50)	1/0 (50)
Max Recommended Input Conductor Length In Feet (Meters)	323 (98)	352 (107)
Min Grounding Conductor Size In AWG 4 (mm <sup>2</sup> )	4 (25)	4 (25)

Reference: 2014 National Electrical Code (NEC) (including article 630)

- 1 If a circuit breaker is used in place of a fuse, choose a circuit breaker with time-current curves comparable to the recommended fuse.
- 2 "Time-Delay" fuses are UL class "RK5" . See UL 248.
- 3 "Normal Operating" (general purpose - no intentional delay) fuses are UL class "K5" (up to and including 60 amps), and UL class "H" ( 65 amps and above).
- 4 Conductor data in this section specifies conductor size (excluding flexible cord or cable) between the panelboard and the equipment per NEC Table 310.15(B)(16). If a flexible cord or cable is used, minimum conductor size may increase. See NEC Table 400.5(A) for flexible cord and cable requirements.

## 5-5. Connecting Input Power

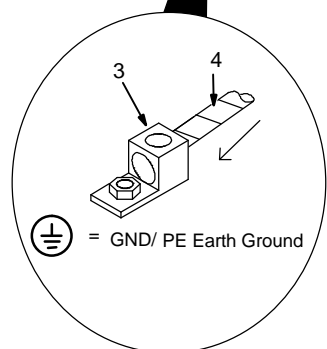
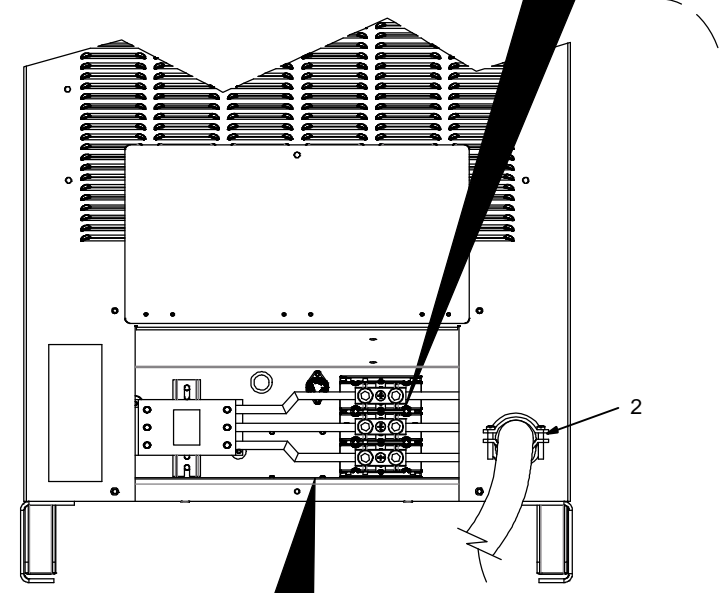
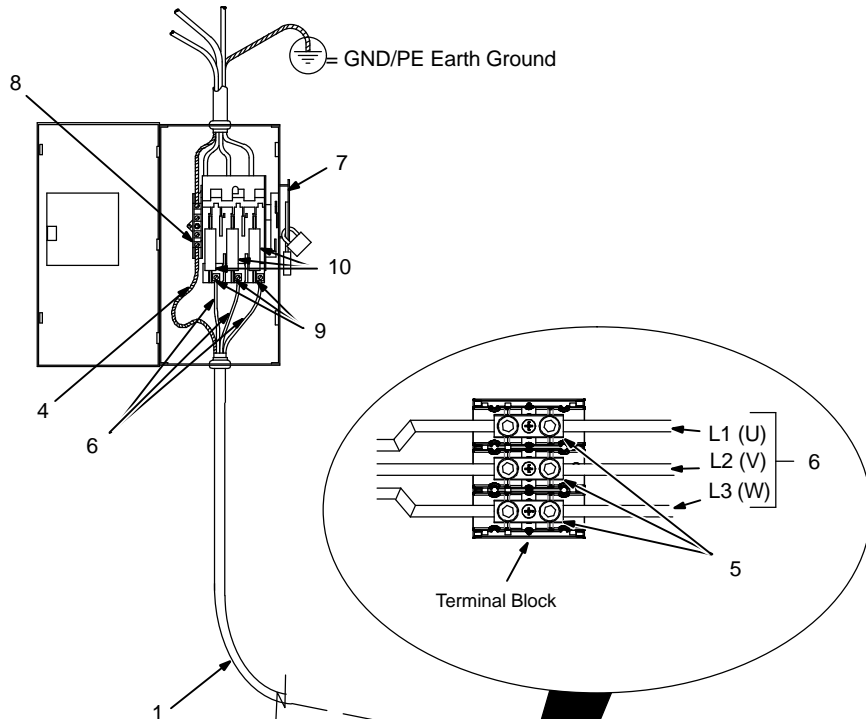

**Tools Needed:**

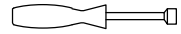
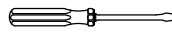
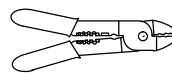
-  7/16 in.
-  3/8 in.
- 
-  3/16 in.



## 5-5. Connecting 3-Phase Input Power (Continued)



**!** Installation must meet all National and Local Codes – have only qualified persons make this installation.

**!** Disconnect and lockout/tagout input power before connecting input conductors from unit. Follow established procedures regarding the installation and removal of lockout/tagout devices.

**!** Make input power connections to the welding power source first.

**!** Always connect green or green/yellow conductor to supply grounding terminal first, and never to a line terminal.

**!** When using multiple units which will be linked with the synchronizing terminal strip TE1, ensure that primary input power conductors are connected to each unit in the same sequence (L1 to L1, L2 to L2, and L3 to L3.)

See rating label on unit and check input voltage available at site.

1 Input Power Conductors (Customer Supplied Cord)

Select size and length of conductors using Section 5-4. Conductors must comply with national, state, and local electrical codes. If applicable, use lugs of proper amperage capacity and correct hole size.

**Welding Power Source Input Power Connections**

2 Strain Relief (Customer Supplied)

Install strain relief of proper size for unit and conductors. Route conductors (cord) through strain relief and tighten screws.

3 Welding Power Source Grounding Terminal

4 Green Or Green/Yellow Grounding Conductor

Connect green or green/yellow grounding conductor to welding power source grounding terminal first.

5 Welding Power Source Line Terminals

6 Input Conductors L1 (U), L2 (V) And L3 (W)

Connect input conductors L1 (U), L2 (V) and L3 (W) to welding power source line terminals.

Close and secure access door on welding power source.

**Disconnect Device Input Power Connections**

7 Disconnect Device (switch shown in OFF position)

8 Disconnect Device (Supply) Grounding Terminal

9 Disconnect Device Line Terminals

Connect green or green/yellow grounding conductor to disconnect device grounding terminal first.

Connect input conductors L1 (U), L2 (V) And L3 (W) to disconnect device line terminals.

10 Over-Current Protection

Select type and size of over-current protection using Section 5-4 (fused disconnect switch shown).

Close and secure door on line disconnect device. Follow established lockout/tagout procedures to put unit in service.

input3 2012-05

## Notes

---



---



---



---



---



---



---



---



---



---

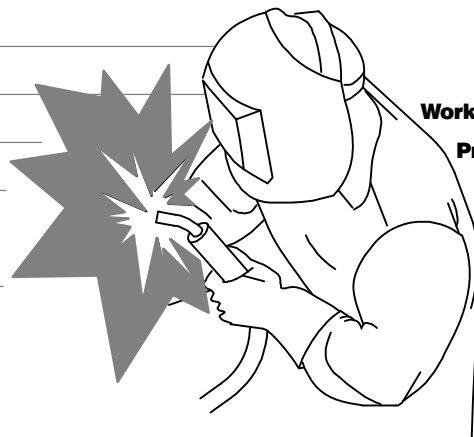

**Work like a Pro!**

**Pros weld and cut safely.  
Read the safety rules at  
the beginning of this  
manual.**

## 5-6. Matching Primary Lines L1, L2, And L3 When Using Multiple AC Units

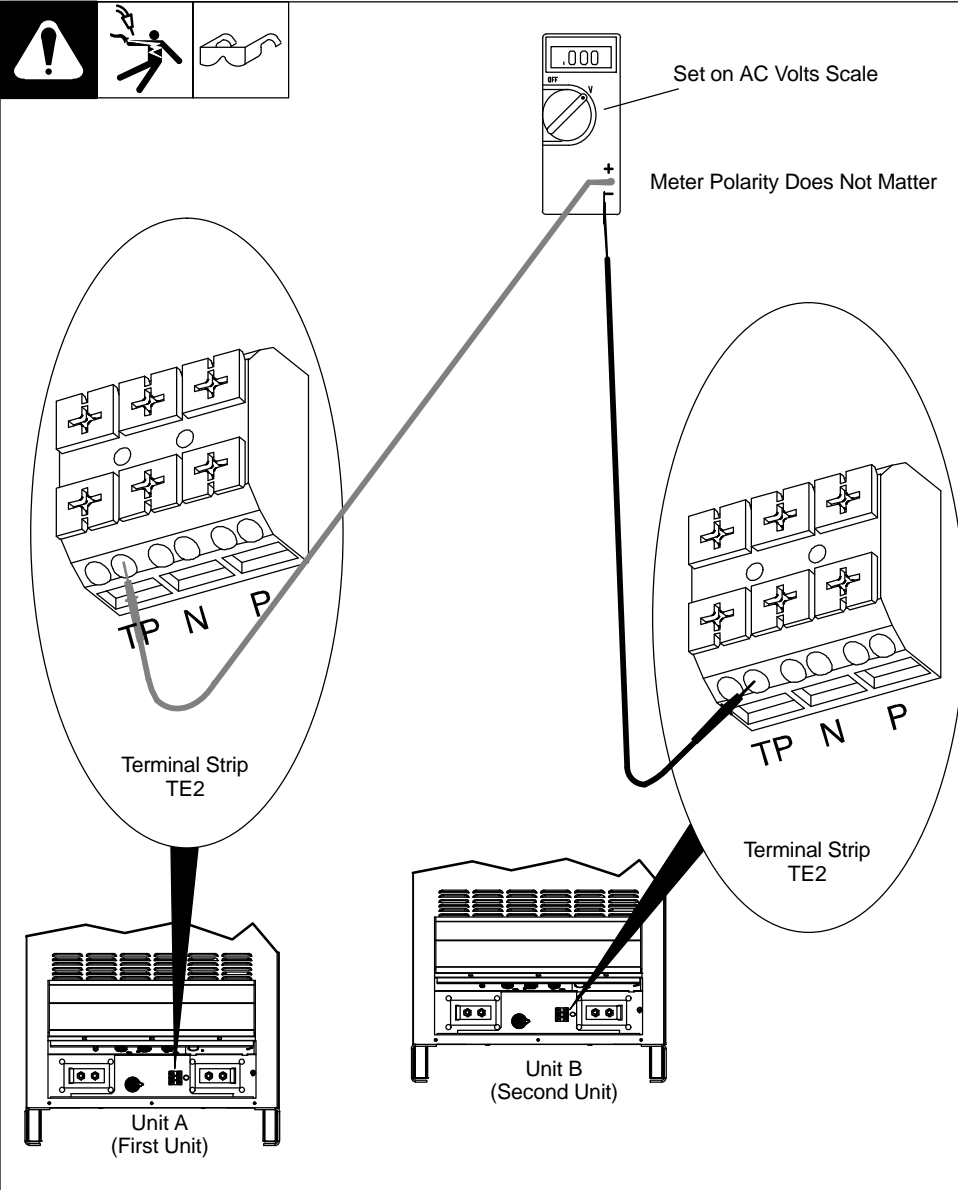

**⚠ Only qualified persons should install, operate, maintain, and repair this unit.**

This test must be performed on the units that will be interconnected using the test point (TP) terminal strip TE2. This refers to the multiple unit hook-ups shown in Section 7-6.

Turn power On to both units. Use an AC voltmeter to measure the voltage between terminal TP of terminal strip TE2 on both units as shown.

If the measured voltage is approximately 0 (zero) volts, the primary lines are properly phased.

**⚠ Turn off welding power source and disconnect and lockout/tagout input power before changing connections at primary input contactor.**

If the measured voltage is approximately 53 volts, swap the input conductor connections to L1 and L3 on the primary input contactor of unit B.

If the measured voltage is approximately 46 volts, swap L1 and L2 on the primary input contactor of unit B. The meter will then read either approximately 53 volts or approximately 26 volts. If the meter reads approximately 53 volts, swap L1 and L3. If the meter reads approximately 26 volts, swap L2 and L3.

If the measured voltage is approximately 26 volts, swap L1 and L2 on the primary input contactor of unit B. The meter will then read either approximately 0 (zero) volts or approximately 46 volts. If the meter reads approximately 0 volts, the primary lines are properly phased. If the meter reads approximately 46 volts, swap L1 and L2 again, and swap L2 and L3.

When the second unit's primary line phase sequences are matched with the first unit, test primary phasing between third unit (if applicable) and second unit. Always test and correct phasing between following unit and unit previous to it.

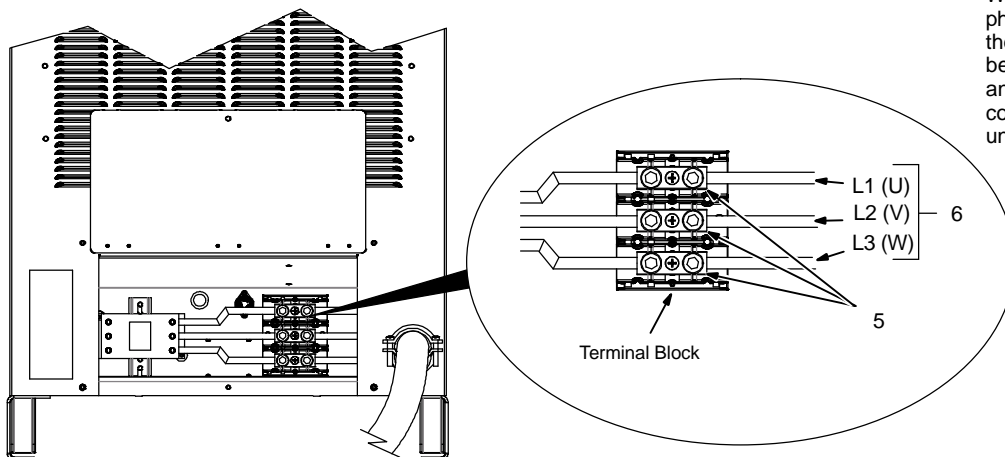

## 5-7. Cable Routing Diagram

- 1 SubArc AC/DC Digital Series Welding Power Source
- 2 Work Sense Lead
- 3 SubArc Interface
- 4 Interface Cable
- 5 Torch
- 6 Workpiece
- 7 Weld Cable
- 8 Work Cable

Keep weld and work cables in close proximity to each other.

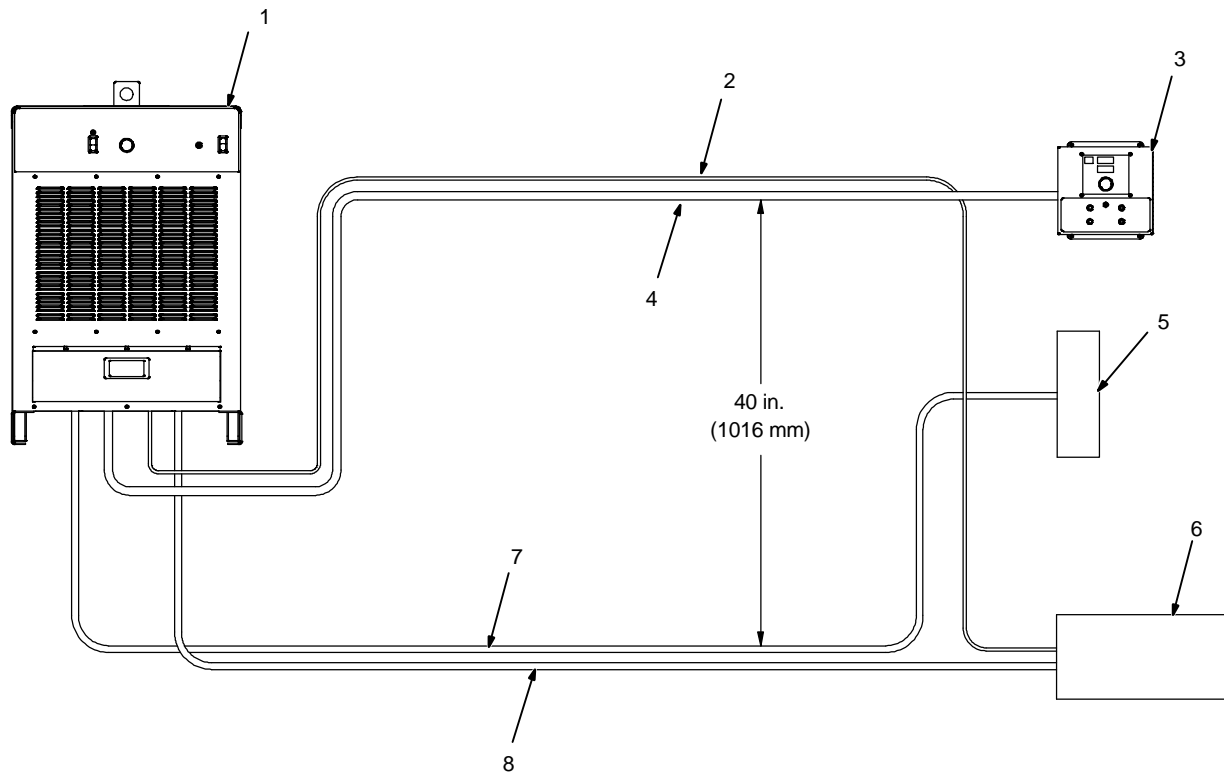

## SECTION 6 – SYSTEM CONNECTIONS

### 6-1. Terminal Strip TE2 and Remote Receptacle RC1 Information For Power Sources

Function	Socket On RC1	Terminal On TE2	Contact Information
Electrical Input Power	A, B	–	24 VAC. Protected by circuit breaker CB2.
	C, D	–	24 VAC common.
Accessory Serial Communication	J	–	+Accessory RS–485 communication.
	V	–	–Accessory RS–485 communication.
	Q	–	Accessory serial communication common.
Shield	H	–	Contact E/F shield drain lead.
Power Source Serial Communication	P	–	+Power source RS–485 communication.
	N	–	–Power source RS–485 communication.
	Z	–	Power source serial communication common.
Shield	G	–	Contact H/J shield drain lead.
PS/PS Communication	K	–	Communication link in.
Power Source Synchronization	E	–	Synchronization in.
Volt Sense	W	–	+ Volt sense.
	X	–	Reserved for – volt sense.
Shield	N	–	Contact M/L shield drain lead.
Remote Voltage Sensing	–	N	Voltage sensing signal from Work weld output terminal.
	–	P	Voltage sensing signal from Electrode weld output terminal.
	–	TP	Test point.
– Not Applicable			



**⚠ Turn Off welding power source before opening access door.**

- 1 Access Door
- 2 Remote Receptacle RC1 (Mounted Inside Access Area)
- 3 Terminal Strip TE2
- 4 SubArc Interface

Connect RC1 on SubArc Interface to Remote receptacle RC1 on power source.

- 5 Modbus RTU
- For use with optional PLC control.

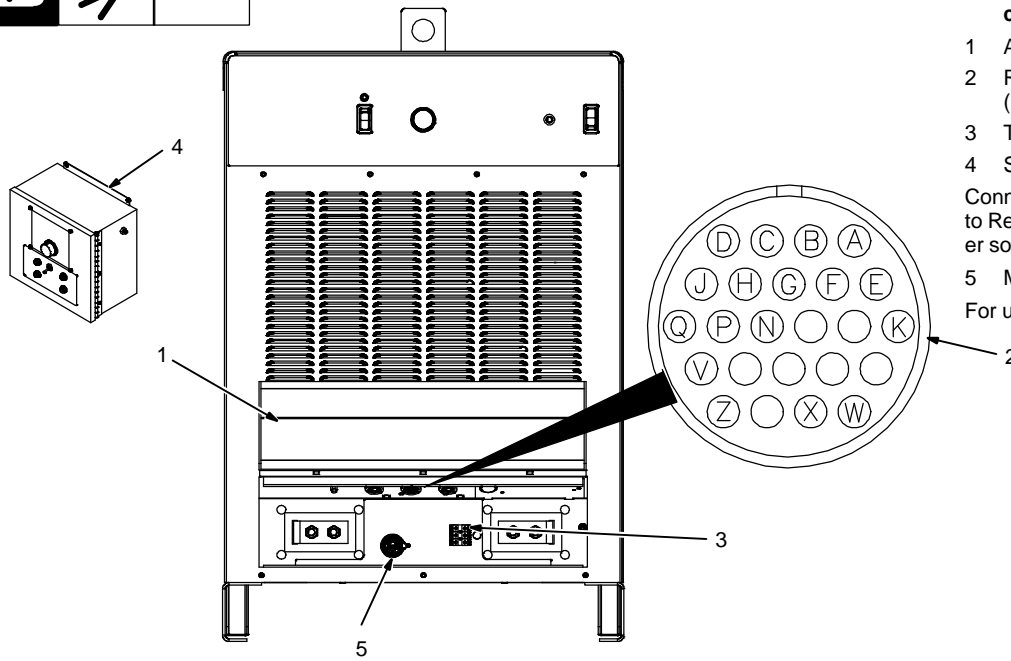

Ref. 265 690-A

## 6-2. Terminal Strip TE1

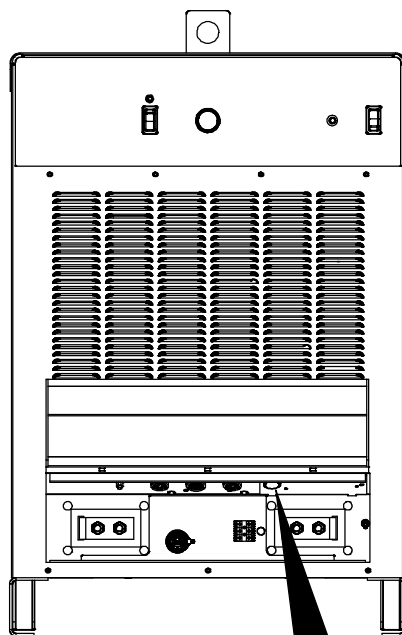

**⚠ Turn Off welding power source and disconnect input power before opening access door.**

**1 Access Hole**

Remove knockout or cover from access hole and install customer supplied strain relief. Route cable connections through the access hole.

**2 12-Pole Terminal Strip**

**3 Label**

Remove and retain screws and open terminal strip panel. Make connections per the label on the panel. Close panel and replace screws.

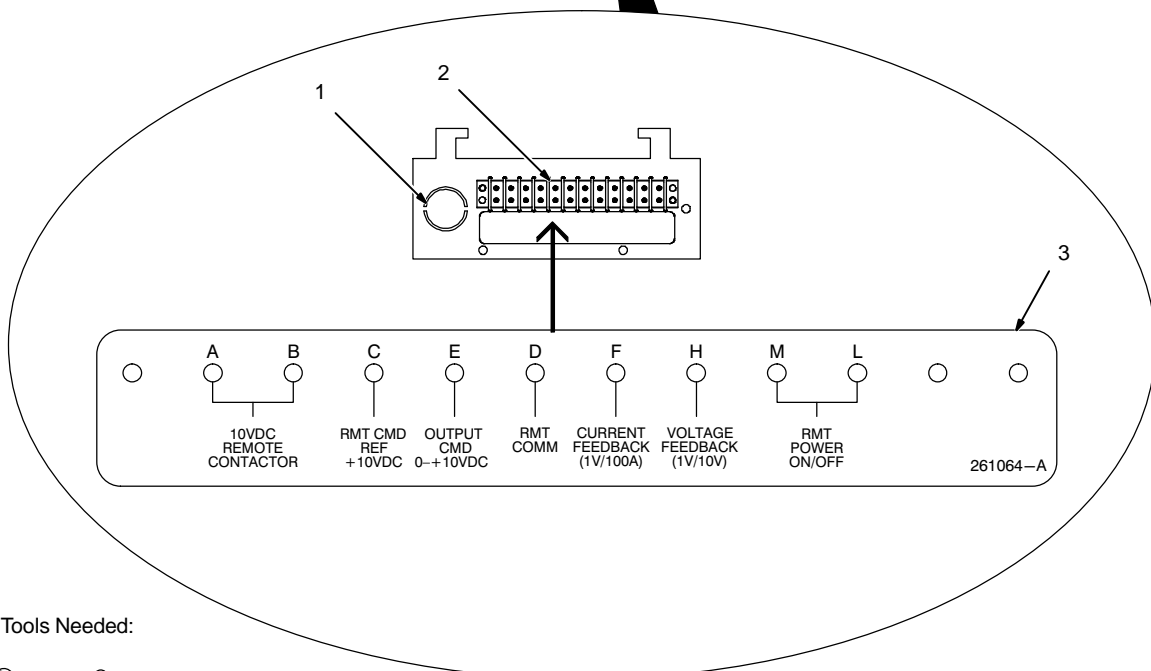

Tools Needed:

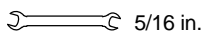

265690-B / 261064-A

Terminal	Function Information
A	10 VDC remote contactor.
B	Connecting terminals A and B will enable output.
C	Remote command reference +10 VDC. Connecting terminals C, D, and E will allow remote control.
E	Output command 0 – +10 VDC. Connecting terminals C, D, and E will allow remote control.
D	Remote common.
F	Connecting terminals F and D will provide current feedback (1V/100A).
H	Connecting terminals H and D will provide voltage feedback (1V/10A).
M	Remote power on/off.
L	Connecting a switch to terminals M and L allow the power source to be remotely turned on or off.

# SECTION 7 – MAKING WELD OUTPUT CONNECTIONS

## 7-1. Weld Output Terminals And Selecting Cable Sizes\*

**NOTICE** – The Total Cable Length in Weld Circuit (see table below) is the combined length of both weld cables. For example, if the power source is 100 ft (30 m) from the workpiece, the total cable length in the weld circuit is 200 ft (2 cables x 100 ft). Use the 200 ft (60 m) column to determine cable size.

Welding Amperes	Weld Cable Size** and Total Cable (Copper) Length in Weld Circuit Not Exceeding***							
	100 ft (30 m) or Less		150 ft (45 m)	200 ft (60 m)	250 ft (70 m)	300 ft (90 m)	350 ft (105 m)	400 ft (120 m)
	10 – 60% Duty Cycle AWG (mm <sup>2</sup> )	60 – 100% Duty Cycle AWG (mm <sup>2</sup> )	10 – 100% Duty Cycle AWG (mm <sup>2</sup> )					
100	4 (20)	4 (20)	4 (20)	3 (30)	2 (35)	1 (50)	1/0 (60)	1/0 (60)
150	3 (30)	3 (30)	2 (35)	1 (50)	1/0 (60)	2/0 (70)	3/0 (95)	3/0 (95)
200	3 (30)	2 (35)	1 (50)	1/0 (60)	2/0 (70)	3/0 (95)	4/0 (120)	4/0 (120)
250	2 (35)	1 (50)	1/0 (60)	2/0 (70)	3/0 (95)	4/0 (120)	2x2/0 (2x70)	2x2/0 (2x70)
300	1 (50)	1/0 (60)	2/0 (70)	3/0 (95)	4/0 (120)	2x2/0 (2x70)	2x3/0 (2x95)	2x3/0 (2x95)
350	1/0 (60)	2/0 (70)	3/0 (95)	4/0 (120)	2x2/0 (2x70)	2x3/0 (2x95)	2x3/0 (2x95)	2x4/0 (2x120)
400	1/0 (60)	2/0 (70)	3/0 (95)	4/0 (120)	2x2/0 (2x70)	2x3/0 (2x95)	2x4/0 (2x120)	2x4/0 (2x120)
500	2/0 (70)	3/0 (95)	4/0 (120)	2x2/0 (2x70)	2x3/0 (2x95)	2x4/0 (2x120)	3x3/0 (3x95)	3x3/0 (3x95)
600	3/0 (95)	4/0 (120)	2x2/0 (2x70)	2x3/0 (2x95)	2x4/0 (2x120)	3x3/0 (3x95)	3x4/0 (3x120)	3x4/0 (3x120)
700	4/0 (120)	2x2/0 (2x70)	2x3/0 (2x95)	2x4/0 (2x120)	3x3/0 (3x95)	3x4/0 (3x120)	3x4/0 (3x120)	4x4/0 (4x120)
800	4/0 (120)	2x2/0 (2x70)	2x3/0 (2x95)	2x4/0 (2x120)	3x4/0 (3x120)	3x4/0 (3x120)	4x4/0 (4x120)	4x4/0 (4x120)
900	2x2/0 (2x70)	2x3/0 (2x95)	2x4/0 (2x120)	3x3/0 (3x95)				
1000	2x2/0 (2x70)	2x3/0 (2x95)	2x4/0 (2x120)	3x3/0 (3x95)				
1250	2x3/0 (2x95)	2x4/0 (2x120)	3x3/0 (3x95)	4x3/0 (4x95)				
1500	600 (300)	750 (400)	1000 (500)	2x750 (2x400)				

\* This chart is a general guideline and may not suit all applications. If cable overheats, use next size larger cable.

\*\*Weld cable size (AWG) is based on either a 4 volts or less drop or a current density of at least 300 circular mils per ampere. ( ) = mm<sup>2</sup> for metric use

\*\*\*For distances longer than those shown in this guide, call a factory applications rep. at 920-735-4505 (Miller) or 1-800-332-3281 (Hobart).

Ref. S-0007-L 2015-02

## 7-2. Weld Output Terminals

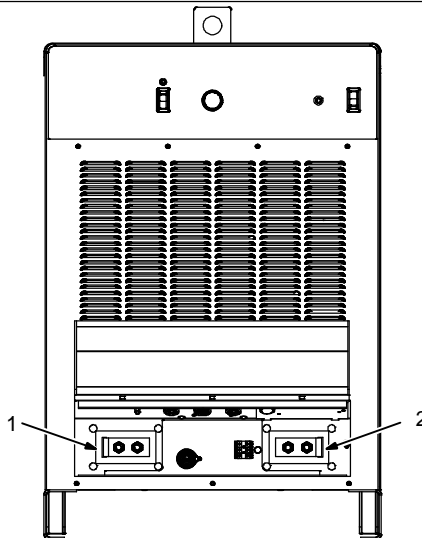

**⚠** Turn off power before connecting to weld output terminals.

**⚠** Do not use worn, damaged, undersized, or repaired cables.

- 1 Electrode Weld Output Terminals
- 2 Work Weld Output Terminals

**ℹ** For welding output terminal connections see Sections 7-4 thru 7-6.

265690-B

output term1 2015-02

### 7-3. Connecting Weld Output Cables



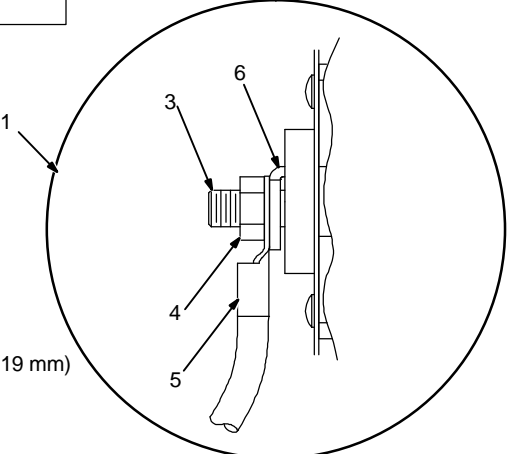

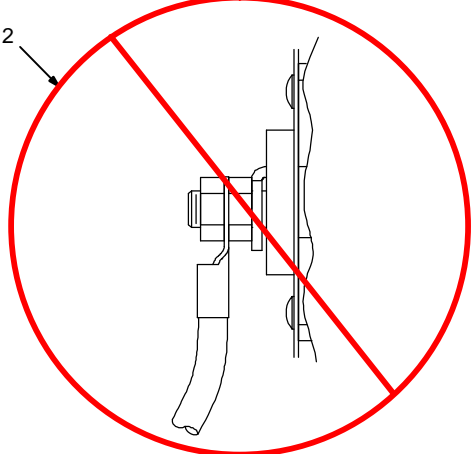

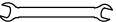
Tools Needed:  
 3/4 in. (19 mm)

**⚠ Turn off power before connecting to weld output terminals.**

**⚠ Failure to properly connect weld cables may cause excessive heat and start a fire, or damage your machine.**

☞ Do not place anything between weld

*cable terminal and copper bar. Make sure that the surfaces of the weld cable terminal and copper bar are clean.*

- 1 Correct Weld Cable Connection
- 2 Incorrect weld Cable Connection
- 3 Weld Output Terminal
- 4 Supplied Weld Output Terminal Nut

- 5 Weld Cable Terminal
- 6 Copper Bar

Remove supplied nut from weld output terminal. Slide weld cable terminal onto weld output terminal and secure with nut so that weld cable terminal is tight against copper bar.

803 778-B

connecting weld output cables

### 7-4. Work And Electrode Cable Connections For Single DC or AC Arcs



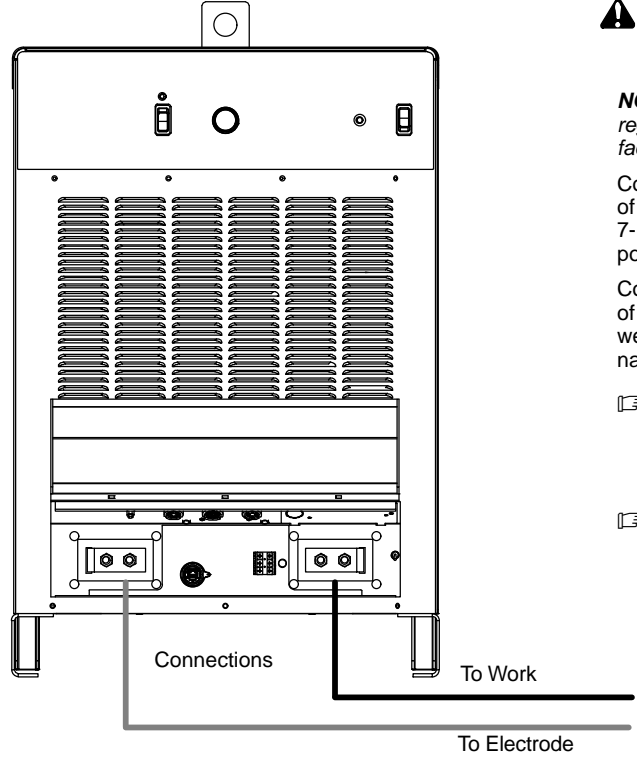

**⚠ Turn Off welding power source before opening access door.**

**NOTICE** – If there are any questions regarding this procedure, contact the factory before connecting units.

Connect the proper size and number of weld output cables (see Section 7-1) to one or more of the welding power source electrode terminals.

Connect the proper size and number of work cables to one or more of the welding power source work terminals.

☞ Run electrode and work cable parallel to each other until separation is required for torch and work cable connections.

☞ Requires cable lugs with 1/2 in. diameter holes.

☞ 3/4 in.

Ref. 265 690-A



## 7-5. Basic Subarc (SAW) Welding

Customer must supply the following: power source, power source control cable, wire drive assembly, wire drive assembly cable, drive rolls, torch, torch tips, welding wire, weld cables, remote voltage sense leads, and flux system for the desired application.

### A. Basic SubArc (SAW) Equipment Connections

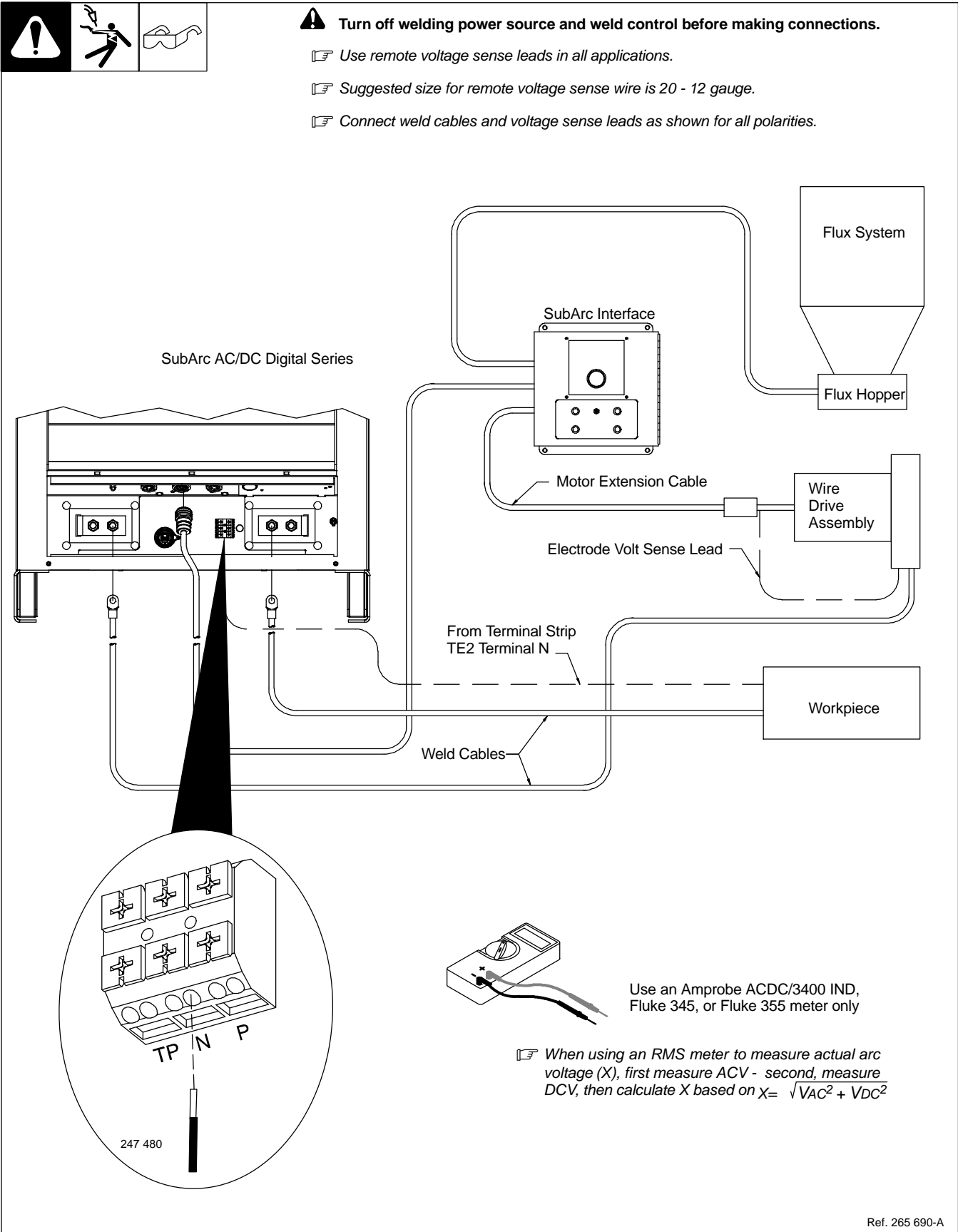

### B. Remote Voltage Sensing Leads Placement Guidelines For A Single Arc (Required)



**BAD**

Sense lead is affected by weld current.

Due to voltage drops across work piece, arc voltage may be low, causing need for deviation from standard procedures.

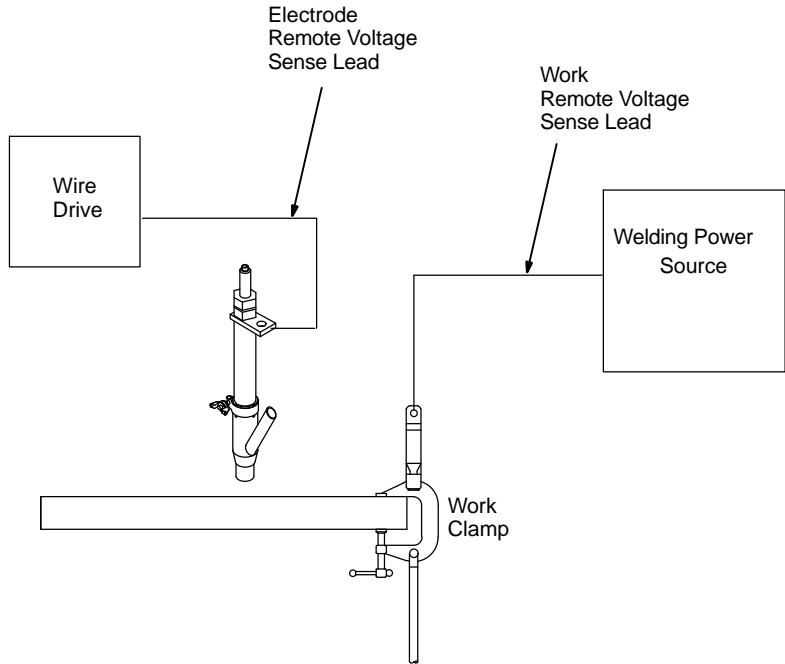

**BEST**

Sense leads are out of the current paths.

Sense leads detect arc voltage accurately.

Best starts, arcs and most reliable results.

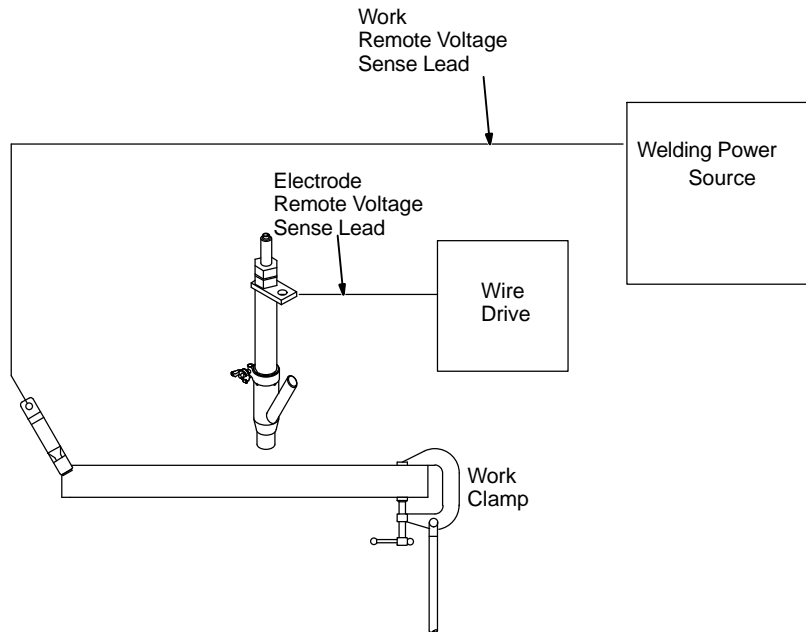

### C. Sensing Leads Placement Guidelines For Multiple Arcs



**BAD**

Current flow from lead affects trail sense.

Current flow from trail affects lead sense.

Neither sense lead picks up the correct work voltage, causing starting and welding arc instability.

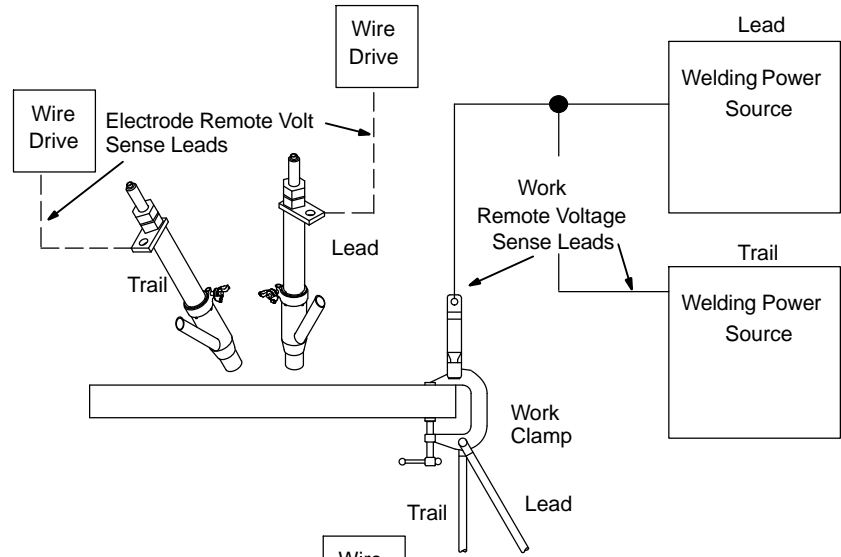

**BAD**

Lead sense is affected by weld current from lead.

Trail sense lead is affected by weld current from trail.

Due to voltage drops across work piece, arc voltage may be low, causing need for deviation from standard procedures.

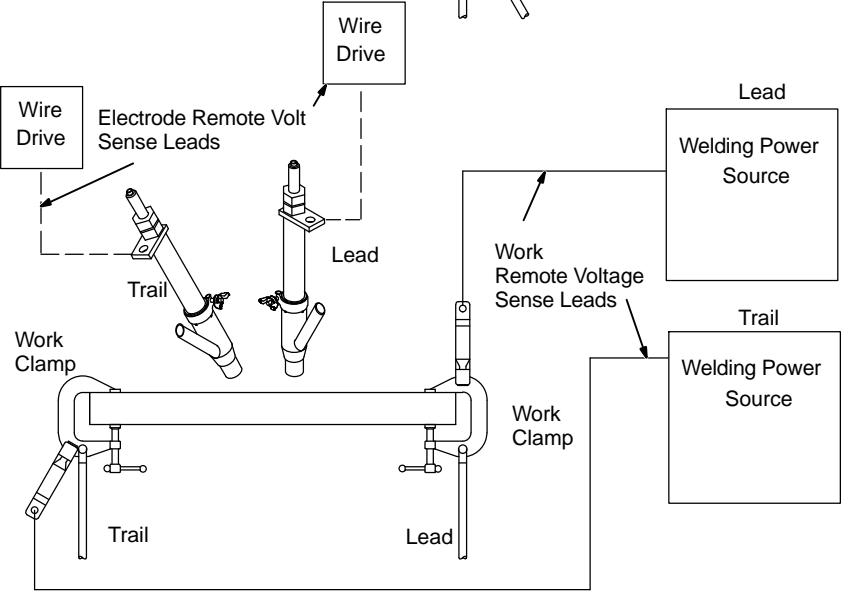

**BEST**

Both sense leads are out of the current paths.

Both sense leads detect arc voltage accurately.

No voltage drop between lead and trail sense.

Best starts, arcs and most reliable results.

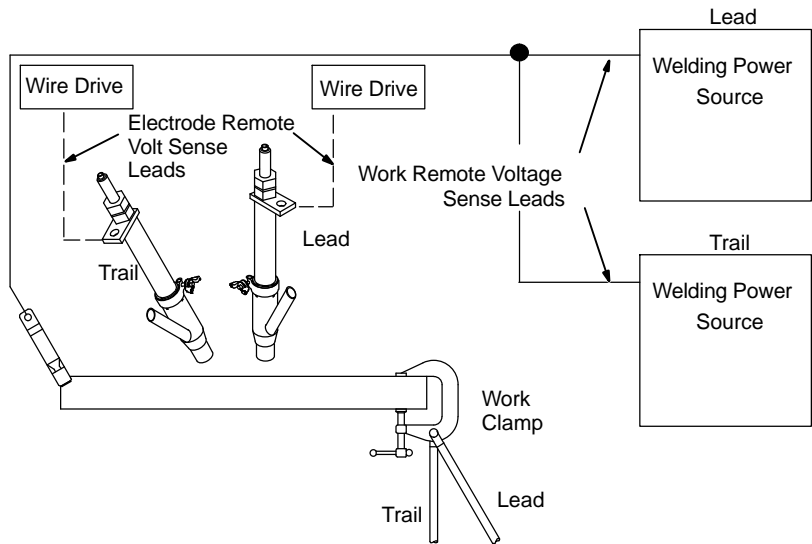

## 7-6. Connecting Multiple Units



**⚠ Turn Off welding power source before opening access door.**

**NOTICE – This procedure is not for paralleling. Refer to connection below for paralleling procedures. Severe damage to units may occur if units are not correctly connected for parallel operation.**

### Tandem Connections:

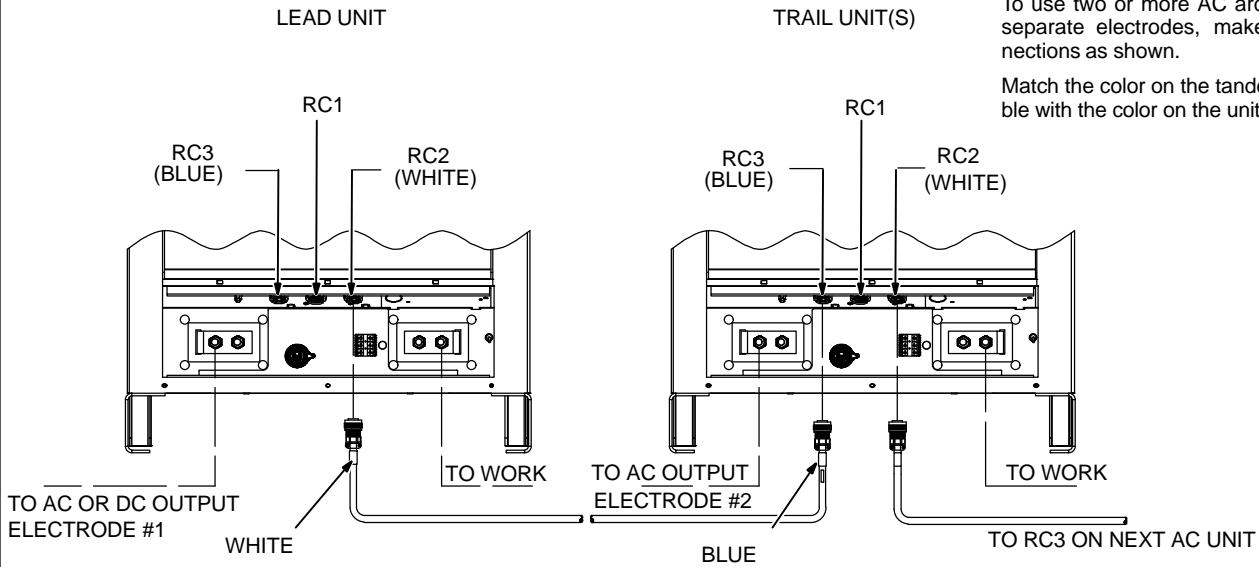

To use two or more AC arcs with separate electrodes, make connections as shown.

Match the color on the tandem cable with the color on the unit.

### Parallel Connections:

**⚠ Turn Off welding power source before opening access door.**

**NOTICE – If there are any questions regarding the paralleling procedure, contact the factory before connecting units. Severe damage to units may occur if units are not correctly connected for parallel operation.**

To use two or more units with one electrode, make connections as shown.

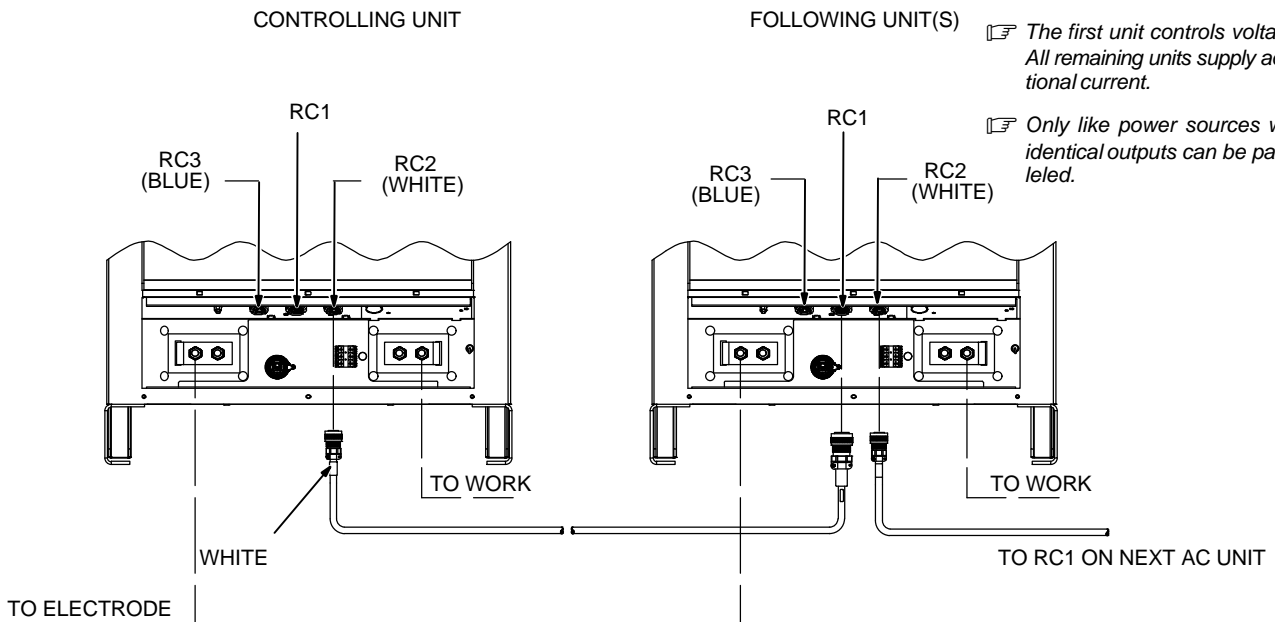

**☞ The first unit controls voltage. All remaining units supply additional current.**

**☞ Only like power sources with identical outputs can be paralleled.**

# SECTION 8 – POWER SOURCE OPERATION

## 8-1. Front Panel Controls For CE And Non-CE Models

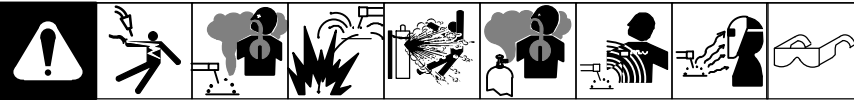

### 1 Output Control Switch

For weld output, place switch in On position. This switch is disabled when a SubArc Interface is connected to the Remote receptacle RC1 and powered on, or when a PLC has active control through the Modbus RTU connector. It is also disabled if the power source is in a parallel or tandem configuration and it is not the primary unit.

### 2 Output On LED

**⚠️ Output is on and weld output studs are energized when LED is lit.**

**⚠️ Turn Off power before connecting re-**

### mote device.

For remote control, connect remote device to Remote receptacle RC1. Remote control provides full range of unit output regardless of A/V Adjust control setting. If the output is on before a remote accessory is powered on, the power source will ignore the accessory until the output is turned off.

### 3 A/V (Amperage/Voltage) Adjustment Control

Use control to select weld voltage when CC/CV switch is in the CV position, or amperage when CC/CV switch is in the CC position.

Control may be adjusted while welding. Numbers on scale are for reference only.

### 4 Power Switch w/Indicator Light

### 5 Status/Trouble LED

See Section 10-1.

### 6 CC/CV Switch

Switch is mounted on electronics baffle.

**⚠️ Turn Off welding power source and disconnect lockout/tagout input power before removing cover to change switch position.**

Place switch in desired position and install cover.

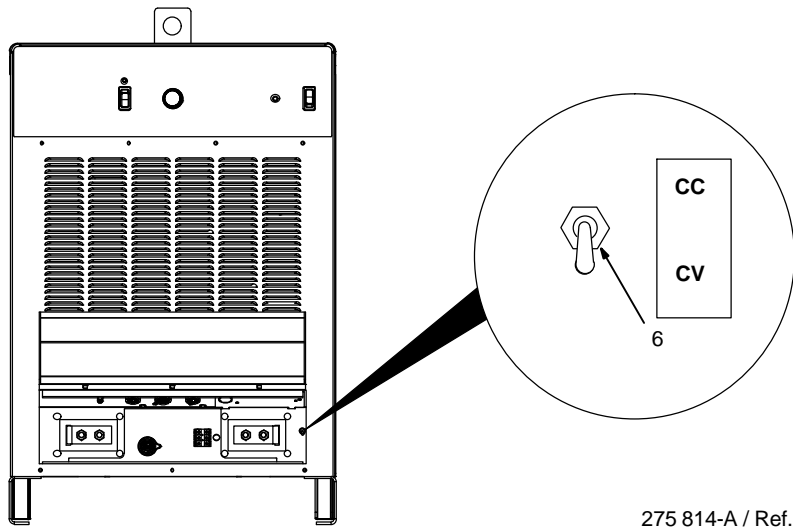
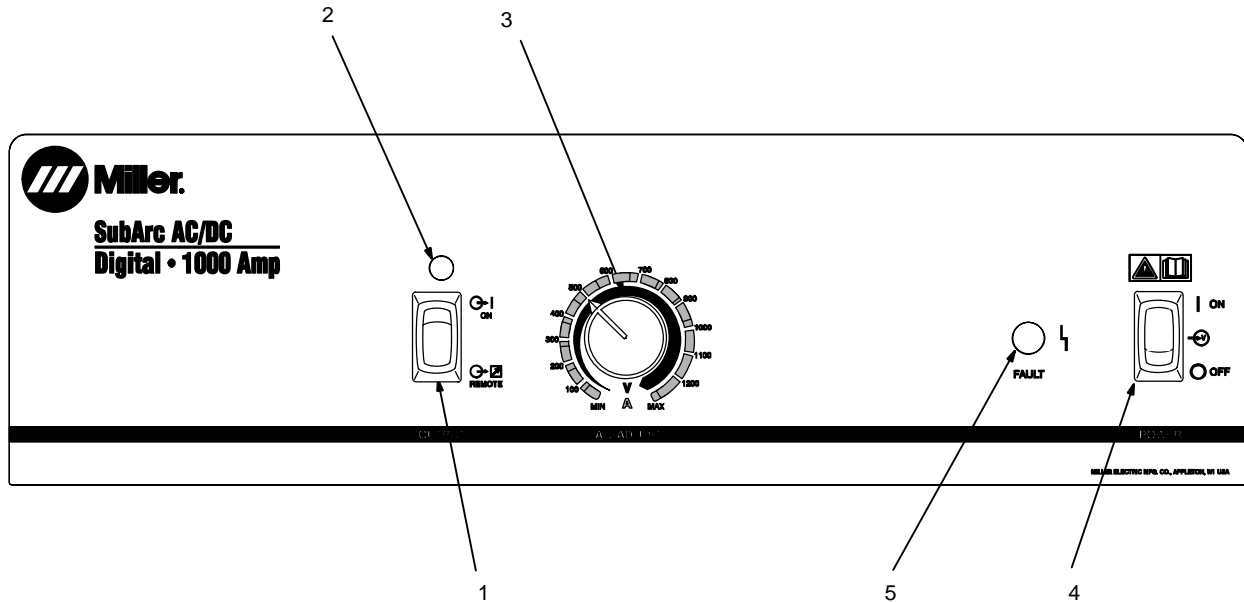

275 814-A / Ref. 265 690-A

# SECTION 9 – PLC OPERATION

## 9-1. Automation Interface Hardware Configuration (PLC Users Only)



1 Switch DIP 1

Configure switch DIP 1 on Automation Interface board PC4 to match the network baud rate and parity settings, and set the MODBUS address for this device. (see Table 9-1 thru Table 9-3).

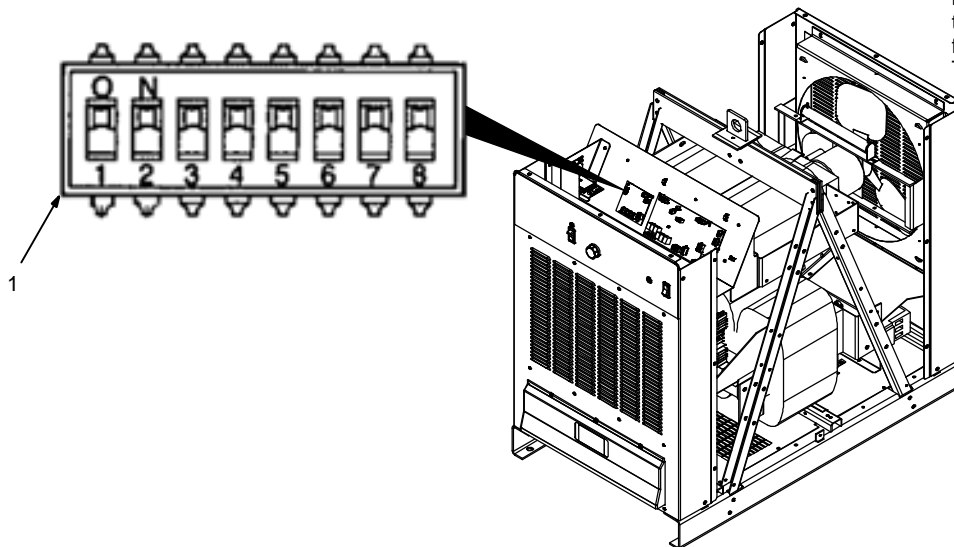

DIP1				Address
1	2	3	4	
ON	ON	ON	ON	40
OFF	ON	ON	ON	41
ON	OFF	ON	ON	42
OFF	OFF	ON	ON	43
ON	ON	OFF	ON	44
OFF	ON	OFF	ON	45
ON	OFF	OFF	ON	46
OFF	OFF	OFF	ON	47
ON	ON	ON	OFF	60
OFF	ON	ON	OFF	61
ON	OFF	ON	OFF	62
OFF	OFF	ON	OFF	63
ON	ON	OFF	OFF	64
OFF	ON	OFF	OFF	65
ON	OFF	OFF	OFF	66
OFF	OFF	OFF	OFF	67

Default Setting

DIP1		Rate
5	6	
ON	ON	9600
OFF	ON	19200
ON	OFF	38400
OFF	OFF	reserved

Default Setting

DIP1		Parity
7	8	
ON	ON	EVEN
OFF	ON	ODD
ON	OFF	NONE
OFF	OFF	reserved

Default Setting

## 9-2. Connection To PLC

The automation interface uses an RJ45 connector to communicate MODBUS RTU over RS485.

**It is NOT an Ethernet connection!**

The pin connections are as follows:

**Table 9-4. Connector Pinout**

Function	RJ45 Pin	Circuit
Digital Communication	4	D+
	5	D-
	8	Common
Shield	Case	Shield

## 9-3. Example Power Source Operation Using A PLC



- To enable welding control from the Automation Interface, set the "Automation Enable" bit (0x4000) in the Command Flags register (MODBUS Holding Register 101).
- Set desired Weld Mode by writing MODBUS Holding Register 105 using look-up table Table 9-6.
- Obtain Minimum and Maximum values by reading from Input Registers section 300 (See Table 9-8).
- Set all relevant parameters (MODBUS Holding Registers 102-107) to their desired values. They must be within the minimum and maximum values read in Step 2. Verify the values are correct by reading Input Registers 102-107.
- Enable weld output by setting the Output Enable Flag to 1 in the Command Flags register (MODBUS Holding Register 101).
- Voltage & Current Feedback values can be read from Input Registers section 200 (See Table 9-8).
- Disable weld output by clearing the Output Enable Flag to 0 in the Command Flags register (MODBUS Holding Register 101).
- If there is no communication from the MODBUS master for a period greater than one second, the power source will reset all registers to their default value. Communication can consist of reading or writing.
- It is recommended to continuously poll all welding parameters via the MODBUS master.

**Table 9-5. MODBUS Function Codes**

Function	Function Code
Read Input Register	4
Read Holding Register	3
Write Single Register	6
Write Multiple Register	16
Read/Write Multiple Register	23

**Table 9-6. MODBUS Holding Registers**

Register Address		Register Name	Register Description
PDU	MODBUS		
100	101	Command Flags	See Table 9-7.
101	102	Weld Voltage Command	Voltage command in 0.1V (used for CV & CV+C).
102	103	Weld Current Command	Current command in 1A (used for CC & CV+C).
103	104	Weld Wire Speed	Wire speed in IPM (only an initial guess in CV+C).
104	105	Weld Mode	See Table 9-10.
105	106	Run-In Speed Percentage	Run-in wire speed percentage (%) of weld wire set-point

106	107	Burn Back Time	Time in which power source is on, with wire stopped, in milliseconds.
107	108	Drive Roll Diameter	Diameter in 0.001 in. Only used when RAD 100 is connected.

**Table 9-7. Command Flags (MODBUS 101)**

Flag Name	Bitmask	Description
Output Enable	0x0001	Enable Weld Output
Wire Jog Up	0x0002	Feed Wire Up
Wire Jog Down	0x0004	Feed Wire Down
Flux On	0x0008	Open Flux Valve
Motor CW	0x2000	Motor Direction (Clockwise=1)
Automation Enable	0x4000	Enable Control From PLC
Reset Faults	0xC000	Fault Reset (All Other Bits MUST Be 0)
Reserved	0x0010 - 0x1000	Reserved For Future Use (MUST Be 0)

**Table 9-8. Input Registers**

Register Address		Register Name	Register Description
PDU	MODBUS		
100	101	Command Flags	Used for holding register verification (see Table 9-6).
101	102	Weld Voltage Command	
102	103	Weld Current Command	
103	104	Weld Wire Speed	
104	105	Weld Mode	
105	106	Run-In Speed Percentage	
106	107	Burn Back Time	
107	108	Drive Roll Diameter	
<b>System Feedback Values</b>			
200	201	Status Flags	See Table 9-9.
201	202	Voltage Feedback	Voltage feedback (volts x 10)
202	203	Current Feedback	Current feedback (amps)
203	204	Help Code	System help code during errors (0 otherwise).
<b>Minimum/Maximum Values (Dependent Upon Power Source, Motor And Weld Mode)</b>			
300	301	Min Voltage	Minimum voltage (0.1V) for MODBUS 102.
301	302	Max Voltage	Maximum voltage (0.1V) for MODBUS 102.
302	303	Min Current	Minimum current (1A) for MODBUS 103.
303	304	Max Current	Maximum current (1A) for MODBUS 103.
304	305	Min WFS	Minimum wire feed speed (IPM) for MODBUS 104.
305	306	Max WFS	Maximum wire feed speed (IPM) for MODBUS 104.
306	307	Min Burnback Time	Minimum burnback time (ms) for MODBUS 107.
307	308	Max Burnback Time	Maximum burnback time (ms) for MODBUS 107.
308	309	Min Drive Roll Diameter	Minimum roll diameter (0.001 in.) for MODBUS 108.
309	310	Max Drive Roll Diameter	Maximum roll diameter (0.001 in.) for MODBUS 108.
<b>System Information</b>			
400	401	Power Source Version	High byte – major version # / low byte – minor version #
401	402	Automation Board Version	High byte – major version # / low byte – minor version #
402	403	Motor Board Version	High byte – major version # / low byte – minor version #
403	404	Display Board Version	High byte – major version # / low byte – minor version #



**Table 9-9. Status Flags (MODBUS 201)**

Flag Name	Bitmask	Description
Valid Arc	0x0001	A valid arc has been detected.
Output On	0x0002	The power source output is on.
Run In	0x0004	The power source is in Run In.
Weld	0x0008	The power source is in the weld state.
Burnback	0x0010	The power source is in the burnback State.
Error	0x8000	The power source is in an Error Condition (read MODBUS Input Register 204).

**Table 9-10. Weld Mode Look Up Table**

Mode	Balance	Line Input Frequency (Hz)		Weld Mode Code
		60 Hz Line	50 Hz Line	
CV	Electrode Positive	---	---	0x0000
	80/20	18	15	0x0001
	75/25	22.5	18.8	0x0002
	70/30	18	15	0x0003
	67/33	30	25	0x0004
	60/40	18	15	0x0005
	50/50	30	25	0x0006
	50/50	18	15	0x0007
	40/60	18	15	0x0008
	33/67	30	25	0x0009
	30/70	18	15	0x000A
	25/75	22.5	18.8	0x000B
20/80	18	15	0x000C	
	Electrode Negative	---	---	0x000D
CV+C	Electrode Positive	---	---	0x4000
	80/20	18	15	0x4001
	75/25	22.5	18.8	0x4002
	70/30	18	15	0x4003
	67/33	30	25	0x4004
	60/40	18	15	0x4005
	50/50	30	25	0x4006
	50/50	18	15	0x4007
	40/60	18	15	0x4008
	33/67	30	25	0x4009
	30/70	18	15	0x400A
	25/75	22.5	18.8	0x400B
20/80	18	15	0x400C	
	Electrode Negative	---	---	0x400D
Mode	Balance	Line Input Frequency (Hz)		Weld Mode Code
		60 Hz Line	50 Hz Line	

**Table 9-10. Weld Mode Look Up Table (continued)**

CC	Electrode Positive	—	—	0x8000
	80/20	18	15	0x8001
	75/25	22.5	18.8	0x8002
	70/30	18	15	0x8003
	67/33	30	25	0x8004
	60/40	18	15	0x8005
	50/50	30	25	0x8006
	50/50	18	15	0x8007
	40/60	18	15	0x8008
	33/67	30	25	0x8009
	30/70	18	15	0x800A
	25/75	22.5	18.8	0x800B
	20/80	18	15	0x800C
	Electrode Negative	—	—	0x800D

## Notes

---

---

---

---

---

---

---

---

---

---

---

---

---

---

---

---

---

---

---

---

---

---

---

---

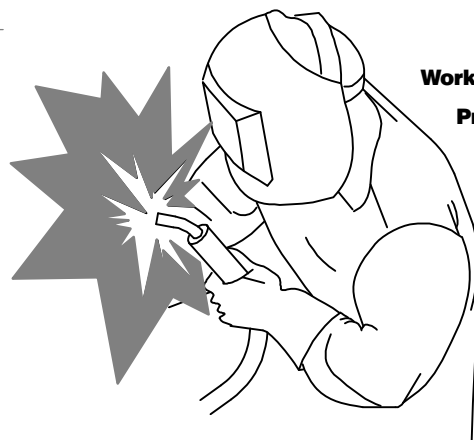

**Work like a Pro!**  
**Pros weld and cut safely.**  
**Read the safety rules at the beginning of this manual.**

# SECTION 10 – MAINTENANCE AND TROUBLESHOOTING





## 10-1. SubArc System Help Codes







SubArc Interface Digital Help Code	SubArc Power Source Status/Trouble Light	Fault	Description
☞ HELP will display in the upper display, and the code number will display in the lower display.	☞ Each flash sequence will be followed by a one second pause. The sequence will then repeat.		
03	3 Slow	See 30	
04	4 Slow	See 40	
05	5 Slow	Primary Circuit Over Temperature	Indicates unit has overheated. Unit has shutdown to allow fans to lower temperature. Operation will continue after unit is within normal temperature range.
06	6 Slow	See 60	
26	2 Quick, 6 Slow	Button Stuck On System Interface Motor Control	Indicates button is stuck on the lower half of the SubArc Interface upon start up, or Remote Start, Jog Up, or Jog Down is being held low during start up. Fault will clear when button is released.
30	3 Quick	Stuck Contactor On Power Source	Indicates stuck contactor on (Output On switch) the power source. Fault will clear when panel switch is set to remote or contactor is released.
32	3 Quick, 2 Slow	Coolant Flow Error	Indicates coolant input on TB2 in the SubArc Interface is not connected to common on TB2 (see appropriate Interface OM).  Check coolant flow and common connections.  Ensure sensor being used has a normally-open contact. Sensor is only active if a Strip Drive 100 is connected.
40	4 Quick	Tach Error	Indicates tach error on motor. Check wire feed drive housing and wire spool for obstructions. Make sure motor cable is not routed with weld cable (If inching works properly, noise may be corrupting the tach signal). If this code continues to appear on the display, contact the nearest Factory Authorized Service Agent.
42	4 Quick, 2 Slow	Motor Error	Indicates motor overcurrent error on motor. Check wire feed drive housing and wire spool for obstructions. If this code continues to appear on the display, contact the nearest Factory Authorized Service Agent.
44	4 Quick, 4 Slow	Motor Low Bus	Indicates bus voltage in SubArc Interface is low. 24 VAC from power source may be low if input primary line voltage is too low or, for DC power sources, power source could be incorrectly linked. Increase primary line voltage to at least 90% of specified nominal voltage. Check for correct linking on DC power sources. If this code continues to appear, contact nearest Factory Authorized Service Agent.
45	4 Quick, 5 Slow	Button Stuck On System Interface Digital Display Board	Indicates button is stuck on the digital interface upon power up. Fault will clear when button is released.
48	4 Quick, 8 Slow	Trigger Fault	Indicates an arc was not established with the specified time (lesser of 8 seconds or 4 inches).
56	5 Quick, 6 Slow	Modbus Control Fault	Indicates PLC is enabling weld output, flux, or wire jog on initial communication. Clear all control bits of MODBUS 101 to reset.
60	6 Quick	Memory Card Fault	Indicates unable to read memory card. Faulty memory card or wrong format.
61	6 Quick, 1 Slow	File Read Error	Indicates faulty file on memory card.
62	6 Quick, 2 Slow	File Write Error	Indicates full or faulty memory card.

## 10-1. SubArc System Help Codes (Continued)

SubArc Interface Digital Help Code	SubArc Power Source Status/Trouble Light	Fault	Description
☞ HELP will display in the upper display, and the code number will display in the lower display.	☞ Each flash sequence will be followed by a one second pause. The sequence will then repeat.		
63	6 Quick, 3 Slow	Invalid File	Indicates an invalid file on memory card. The system was able to read the file; however, the contents of the file were invalid. Remove card or press any button to clear error.
64	6 Quick, 4 Slow	Memory Card Locked	Indicates a save was attempted to a locked card. This refers to the physical switch on the memory card. Unlock the memory card and try again. Try a different memory card. Remove card or press any button to clear error. If this code continues to appear on the display, contact the nearest Factory Authorized Service Agent.
65	6 Quick, 5 Slow	Read Only File	Indicates a save was attempted to a file that has been marked read-only. Check with the appropriate person to see if the attributes are read only for a reason (the attributes can be altered using a PC). Use a different card. Remove card or press any button to clear error.
66	6 Quick, 6 Slow	No Memory Card Detected	Indicates no memory card detected when a memory card operation was attempted. Insert a card or press any button to clear error. Try a different memory card. If this code continues to appear on the display, contact the nearest Factory Authorized Service Agent.
67	6 Quick, 7 Slow	Unsupported Memory Card Format	Indicates the file system is not supported. Memory card size is too small.
71	7 Quick, 1 Slow	Invalid Model Type	If paralleling units, firmware in controlling power source does not match firmware in the following power source. Update firmware in both machines to the latest revision. If code continues to display, contact nearest Factory Authorized Service Agent.
72	7 Quick, 2 Slow	Invalid Motor Type	Indicates resistor is missing or improperly installed in motor cable. Make sure the motor being used is support by this system (see Section4-3). Check motor to system interface control cable connection and tighten if necessary (See Section 7-5). If this code continues to appear on the display, contact the nearest Factory Authorized Service Agent.
73	7 Quick, 3 Slow	Program Select Error	Indicates an invalid program has been selected using the program select inputs on the terminal strip. The program select is not available because locks are enabled. This error will only occur with program select mode enabled.
92	9 Quick, 2 Slow	Parallel Communication Loss	On trail unit – indicates communication cannot be established with lead unit. On lead unit – indicates communication was lost during welding.
93	9 Quick, 3 Slow	PLC Communication Loss	Indicates communication with PLC was lost during welding.
94	9 Quick, 4 Slow	Automation Interface Communication Loss	Indicates communication with Automation Interface was lost during welding.
95	9 Quick, 5 Slow	Serial Communication Loss	Indicates that the Process Control board lost communication with the Motor Control board in the SubArc Interface.
97	9 Quick, 7 slow	Primary Communication Lost	Power source process control board cannot communicate with the output controller. Power cycle unit. If problem persists, contact the nearest Factory Authorized Service Agent.
98	9 Quick, 8 Slow	Serial Communication Loss	Indicates serial communication was initially made and is now malfunctioning. Check SubArc Interface/power source control cable connection and tighten if necessary. May appear normally during firmware updates. If this code continues to appear on the display, contact the nearest Factory Authorized Service Agent.
99	9 Quick, 9 Slow	Serial Communication Malfunction	Indicates serial communication is malfunctioning. Check SubArc Interface/power source control cable connection and tighten if necessary. May appear normally during firmware updates. If this code continues to appear on the display, contact the nearest Factory Authorized Service Agent.

## 10-2. Power Source Routine Maintenance

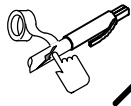
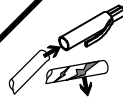
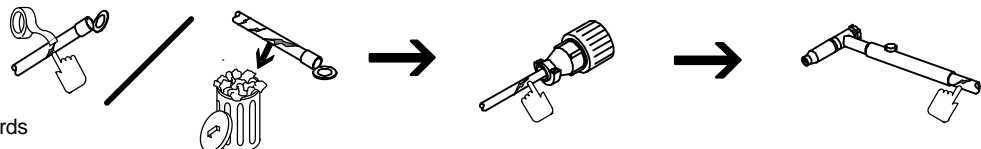
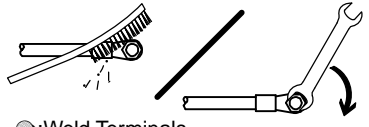
				<p><b>⚠ Disconnect input power before maintaining.</b></p>	<p><i>☞ Maintain more often during severe conditions.</i></p>
---	---	---	---	--	---

		<p>✓ = Check      ◇ = Change      ● = Clean * To be done by Factory Authorized Service Agent</p>	<p>Δ = Repair</p>	<p>☆ = Replace</p>
Every 3 Months	  ✓ ☆ Labels	 ☆ Cracked Parts	 Δ ☆ Cracked Cables	
Every 3 Months	 ✓ Δ ☆ Cables And Cords			
Every 3 Months	 ●: Weld Terminals			
Every 6 Months	 ●: Blow out inside			

## 10-3. Fuse F1

		
---	---	---

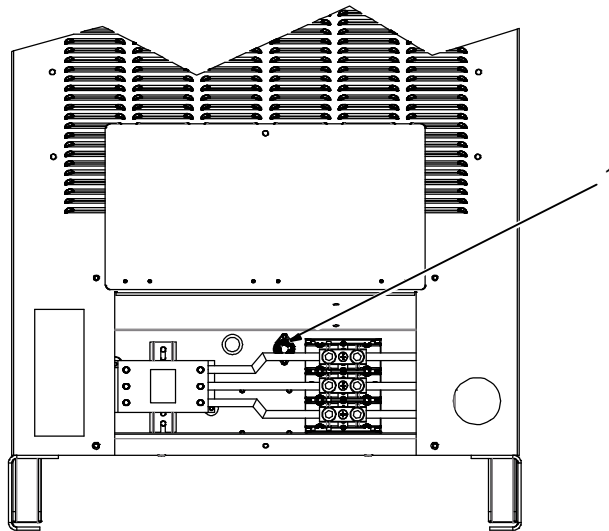

**⚠ Disconnect and lockout/tag-out input power before checking fuse.**

Fuse F1 protect the 400/460 volt AC winding of transformer T2. If fuse F1 opens, the welding power source shuts down.

Open rear panel access door to access fuses.

1 Fuse F1

Check F1 and replace if needed, using a fuse of the same rating.

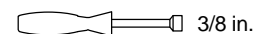

Close and secure rear panel access door.

Tools Needed:



247 479-C

### 10-4. Access Area Supplementary Protectors

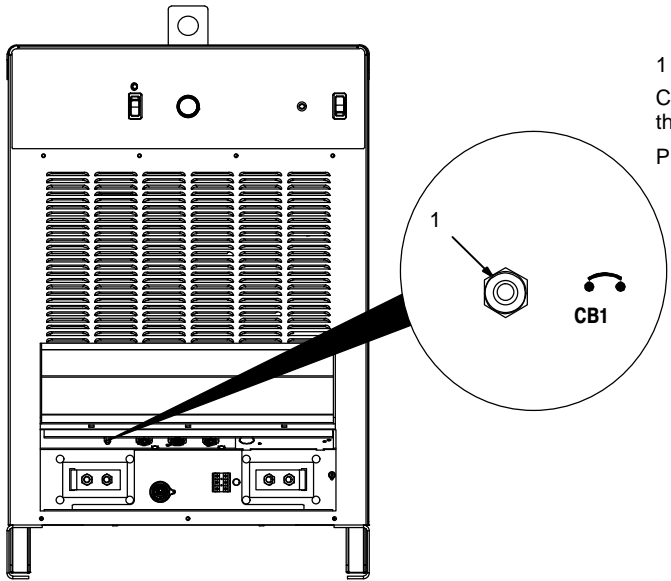

**⚠ Turn Off welding power source before checking circuit breakers.**

1 Supplementary Protector CB1  
CB1 protects the 24 VAC portion of the Remote receptacle.  
Press button to reset breaker.

265 690-A

### 10-5. Power Source Troubleshooting







Trouble	Remedy
No weld output; unit completely inoperative.	Place line disconnect switch in On position (see Section 5-5).
	Check fuse F1 and replace if necessary (see Section 10-3).
	Check and replace line fuse(s), if necessary, or reset circuit breaker (see Section 5-5).
	Check for proper input power connections (see Section 5-5).
No weld output; pilot light On.	Check, repair, or replace system interface.
	Unit overheated. Allow unit to cool with fan On (see Section 4-5).
	Have Factory Authorized Service Agent check control board PC1.
Erratic or improper weld output.	Use proper size and type of weld cable (see Section 7-1).
	Clean and tighten all weld connections.
	Verify proper connection of volt sense leads (see Section 7-5.B, C).
	When using multiple units, make sure all units are properly connected (see Section 7-6), and turned on.
	Have Factory Authorized Service Agent check control board PC1.
No 24 volts AC output at Remote receptacle.	Reset supplementary protector CB1 (see Section 10-4).



# SECTION 11 – ELECTRICAL DIAGRAMS

	<b>⚠ WARNING</b> <ul style="list-style-type: none"> <li>• Do not touch live electrical parts.</li> <li>• Disconnect input power or stop engine before servicing.</li> <li>• Do not operate with covers removed.</li> <li>• Have only qualified persons install, use, or service this unit.</li> </ul>
	<b>ELECTRIC SHOCK HAZARD</b>

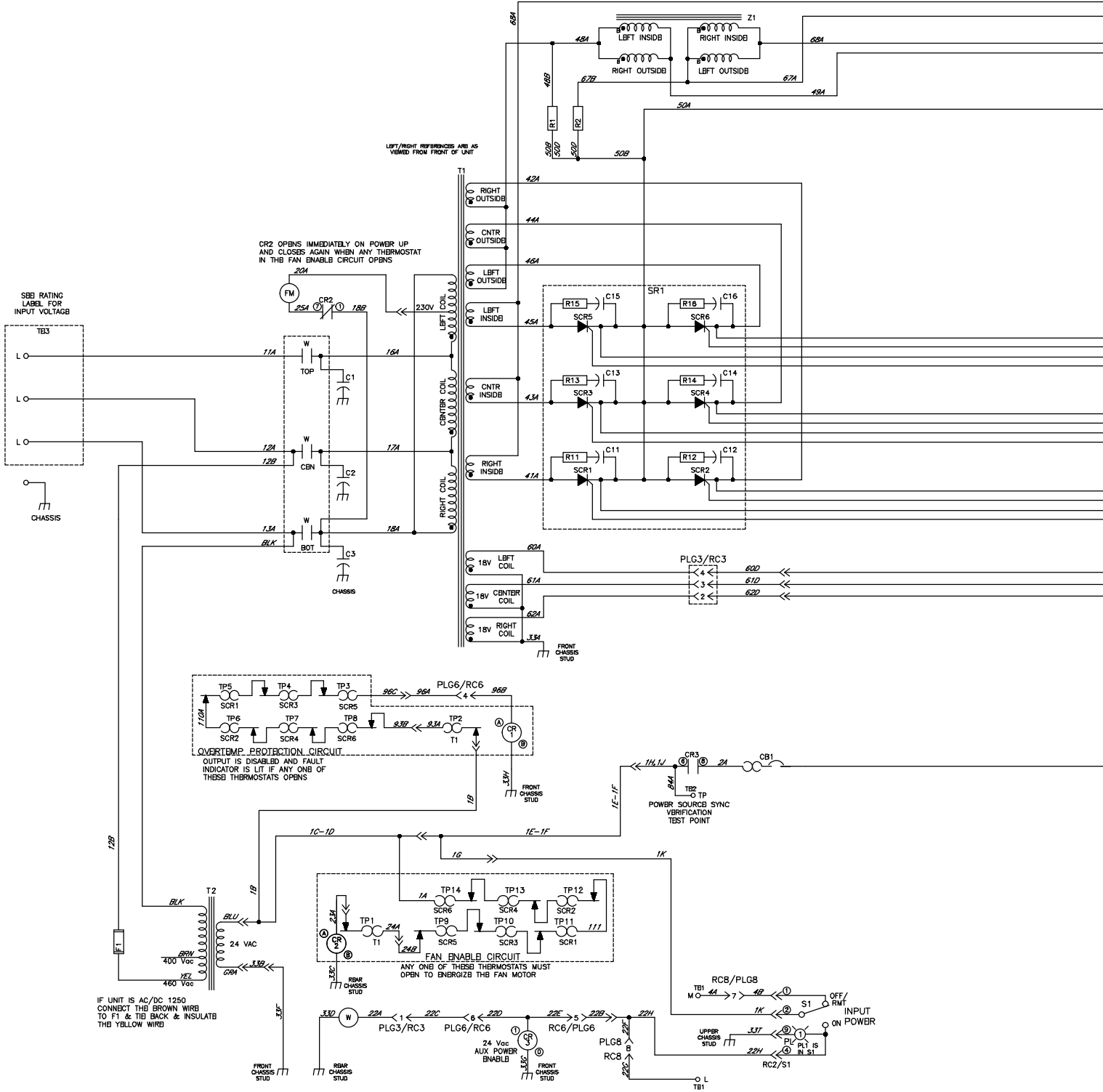
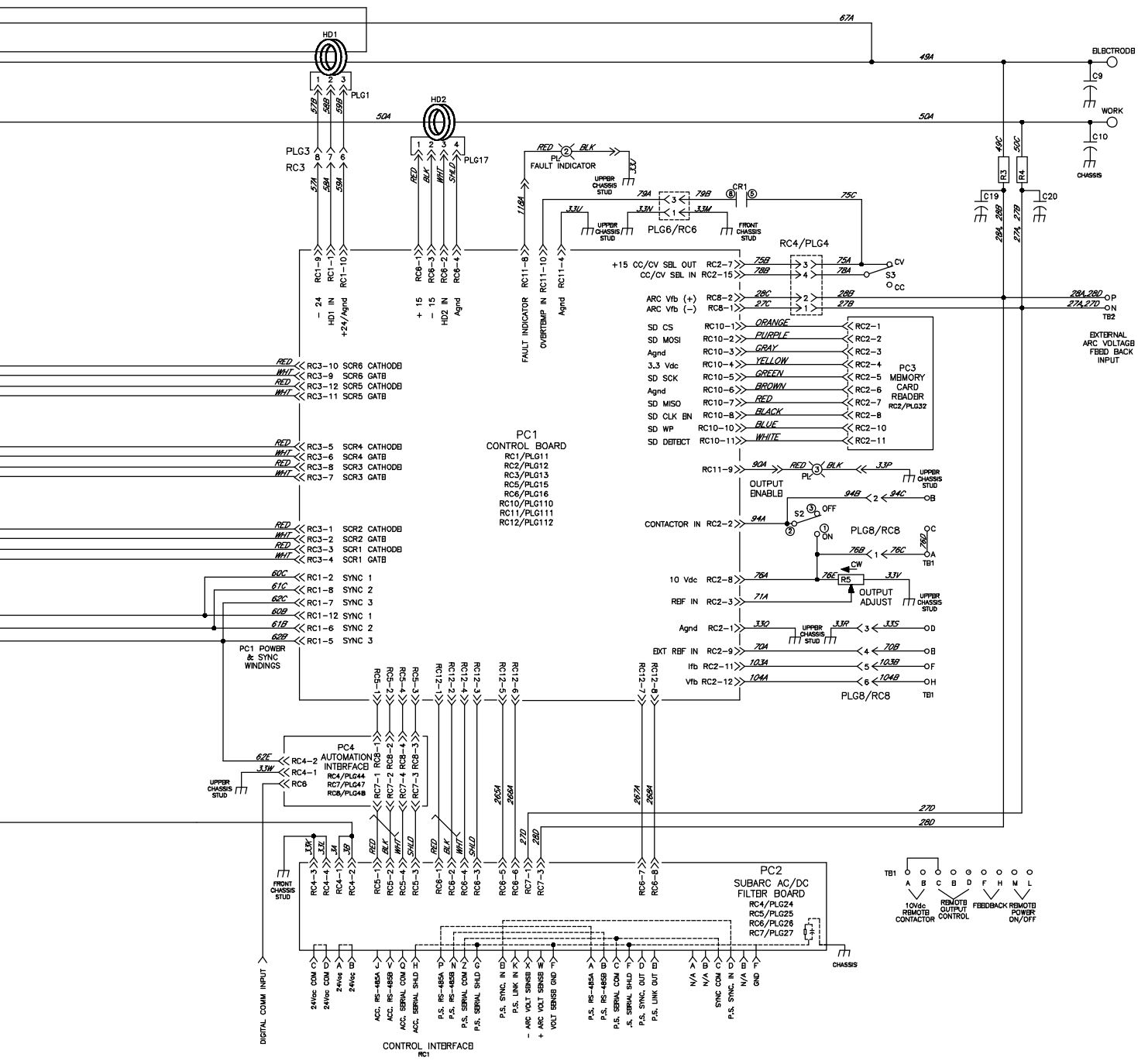

Figure 11.1. Circuit Diagram for SubArc AC/DC Digital Series Models







# TRUE BLUE<sup>®</sup>

## WARRANTY

Effective January 1, 2016

(Equipment with a serial number preface of MG or newer)

This limited warranty supersedes all previous Miller warranties and is exclusive with no other guarantees or warranties expressed or implied.

### Warranty Questions?

Call  
1-800-4-A-MILLER  
for your local  
Miller distributor.

Your distributor also gives  
you ...

### Service

You always get the fast,  
reliable response you  
need. Most replacement  
parts can be in your  
hands in 24 hours.

### Support

Need fast answers to the  
tough welding questions?  
Contact your distributor.  
The expertise of the  
distributor and Miller is  
there to help you, every  
step of the way.

LIMITED WARRANTY – Subject to the terms and conditions below, Miller Electric Mfg. Co., Appleton, Wisconsin, warrants to its original retail purchaser that new Miller equipment sold after the effective date of this limited warranty is free of defects in material and workmanship at the time it is shipped by Miller. THIS WARRANTY IS EXPRESSLY IN LIEU OF ALL OTHER WARRANTIES, EXPRESS OR IMPLIED, INCLUDING THE WARRANTIES OF MERCHANTABILITY AND FITNESS.

Within the warranty periods listed below, Miller will repair or replace any warranted parts or components that fail due to such defects in material or workmanship. Miller must be notified in writing within thirty (30) days of such defect or failure, at which time Miller will provide instructions on the warranty claim procedures to be followed. If notification is submitted as an online warranty claim, the claim must include a detailed description of the fault and the troubleshooting steps taken to identify failed components and the cause of their failure.

Miller shall honor warranty claims on warranted equipment listed below in the event of such a failure within the warranty time periods. All warranty time periods start on the delivery date of the equipment to the original end-user purchaser, and not to exceed twelve months after the equipment is shipped to a North American distributor or eighteen months after the equipment is shipped to an International distributor.

1. 5 Years Parts — 3 Years Labor
  - \* Original Main Power Rectifiers Only to Include SCRs, Diodes, and Discrete Rectifier Modules
2. 3 Years — Parts and Labor
  - \* Auto-Darkening Helmet Lenses (Except Classic Series) (No Labor)
  - \* Engine Driven Welder/Generators  
**(NOTE: Engines are Warranted Separately by the Engine Manufacturer.)**
  - \* Inverter Power Sources (Unless Otherwise Stated)
  - \* Plasma Arc Cutting Power Sources
  - \* Process Controllers
  - \* Semi-Automatic and Automatic Wire Feeders
  - \* Transformer/Rectifier Power Sources
3. 2 Years — Parts and Labor
  - \* Auto-Darkening Helmet Lenses – Classic Series Only (No Labor)
  - \* Fume Extractors – Capture 5, Filtair 400 and Industrial Collector Series
4. 1 Year — Parts and Labor Unless Specified
  - \* Automatic Motion Devices
  - \* CoolBelt and CoolBand Blower Unit (No Labor)
  - \* Desiccant Air Dryer System
  - \* External Monitoring Equipment and Sensors
  - \* Field Options  
**(NOTE: Field options are covered for the remaining warranty period of the product they are installed in, or for a minimum of one year — whichever is greater.)**
  - \* RFCS Foot Controls (Except RFCS-RJ45)
  - \* Fume Extractors – Filtair 130, MWX and SWX Series
  - \* HF Units
  - \* ICE/XT Plasma Cutting Torches (No Labor)
  - \* Induction Heating Power Sources, Coolers  
**(NOTE: Digital Recorders are Warranted Separately by the Manufacturer.)**
  - \* LiveArc Welding Performance Management System
  - \* Load Banks
  - \* Motor-Driven Guns (except Spoolmate Spoolguns)
  - \* PAPR Blower Unit (No Labor)
  - \* Positioners and Controllers
  - \* Racks
  - \* Running Gear/Trailers
  - \* Spot Welders
  - \* Subarc Wire Drive Assemblies
  - \* Water Coolant Systems
  - \* TIG Torches (No Labor)
  - \* Wireless Remote Foot/Hand Controls and Receivers
  - \* Work Stations/Weld Tables (No Labor)

5. 6 Months — Parts
  - \* Batteries
  - \* Bernard Guns (No Labor)
  - \* Tregaskiss Guns (No Labor)
6. 90 Days — Parts
  - \* Accessory (Kits)
  - \* Canvas Covers
  - \* Induction Heating Coils and Blankets, Cables, and Non-Electronic Controls
  - \* M-Guns
  - \* MIG Guns and Subarc (SAW) Torches
  - \* Remote Controls and RFCS-RJ45
  - \* Replacement Parts (No labor)
  - \* Roughneck Guns
  - \* Spoolmate Spoolguns

Miller's True Blue<sup>®</sup> Limited Warranty shall not apply to:

1. **Consumable components; such as contact tips, cutting nozzles, contactors, brushes, relays, work station table tops and welding curtains, or parts that fail due to normal wear. (Exception: brushes and relays are covered on all engine-driven products.)**
2. Items furnished by Miller, but manufactured by others, such as engines or trade accessories. These items are covered by the manufacturer's warranty, if any.
3. Equipment that has been modified by any party other than Miller, or equipment that has been improperly installed, improperly operated or misused based upon industry standards, or equipment which has not had reasonable and necessary maintenance, or equipment which has been used for operation outside of the specifications for the equipment.

MILLER PRODUCTS ARE INTENDED FOR PURCHASE AND USE BY COMMERCIAL/INDUSTRIAL USERS AND PERSONS TRAINED AND EXPERIENCED IN THE USE AND MAINTENANCE OF WELDING EQUIPMENT.

In the event of a warranty claim covered by this warranty, the exclusive remedies shall be, at Miller's option: (1) repair; or (2) replacement; or, where authorized in writing by Miller in appropriate cases, (3) the reasonable cost of repair or replacement at an authorized Miller service station; or (4) payment of or credit for the purchase price (less reasonable depreciation based upon actual use) upon return of the goods at customer's risk and expense. Miller's option of repair or replacement will be F.O.B., Factory at Appleton, Wisconsin, or F.O.B. at a Miller authorized service facility as determined by Miller. Therefore no compensation or reimbursement for transportation costs of any kind will be allowed.

TO THE EXTENT PERMITTED BY LAW, THE REMEDIES PROVIDED HEREIN ARE THE SOLE AND EXCLUSIVE REMEDIES. IN NO EVENT SHALL MILLER BE LIABLE FOR DIRECT, INDIRECT, SPECIAL, INCIDENTAL OR CONSEQUENTIAL DAMAGES (INCLUDING LOSS OF PROFIT), WHETHER BASED ON CONTRACT, TORT OR ANY OTHER LEGAL THEORY.

ANY EXPRESS WARRANTY NOT PROVIDED HEREIN AND ANY IMPLIED WARRANTY, GUARANTY OR REPRESENTATION AS TO PERFORMANCE, AND ANY REMEDY FOR BREACH OF CONTRACT TORT OR ANY OTHER LEGAL THEORY WHICH, BUT FOR THIS PROVISION, MIGHT ARISE BY IMPLICATION, OPERATION OF LAW, CUSTOM OF TRADE OR COURSE OF DEALING, INCLUDING ANY IMPLIED WARRANTY OF MERCHANTABILITY OR FITNESS FOR PARTICULAR PURPOSE, WITH RESPECT TO ANY AND ALL EQUIPMENT FURNISHED BY MILLER IS EXCLUDED AND DISCLAIMED BY MILLER.

Some states in the U.S.A. do not allow limitations of how long an implied warranty lasts, or the exclusion of incidental, indirect, special or consequential damages, so the above limitation or exclusion may not apply to you. This warranty provides specific legal rights, and other rights may be available, but may vary from state to state.

In Canada, legislation in some provinces provides for certain additional warranties or remedies other than as stated herein, and to the extent that they may not be waived, the limitations and exclusions set out above may not apply. This Limited Warranty provides specific legal rights, and other rights may be available, but may vary from province to province.





# Owner's Record

Please complete and retain with your personal records.

Model Name

Serial/Style Number

Purchase Date

(Date which equipment was delivered to original customer.)

Distributor

Address

City

State

Zip



## For Service

Contact a **DISTRIBUTOR** or **SERVICE AGENCY** near you.

Always provide Model Name and Serial/Style Number.

Contact your Distributor for:

Welding Supplies and Consumables

Options and Accessories

Personal Safety Equipment

Service and Repair

Replacement Parts

Training (Schools, Videos, Books)

Technical Manuals (Servicing Information and Parts)

Circuit Diagrams

Welding Process Handbooks

To locate a Distributor or Service Agency visit [www.millerwelds.com](http://www.millerwelds.com) or call 1-800-4-A-Miller

Contact the Delivering Carrier to:

File a claim for loss or damage during shipment.

For assistance in filing or settling claims, contact your distributor and/or equipment manufacturer's Transportation Department.

### Miller Electric Mfg. Co.

An Illinois Tool Works Company  
1635 West Spencer Street  
Appleton, WI 54914 USA

### International Headquarters—USA

USA Phone: 920-735-4505 Auto-Attended  
USA & Canada FAX: 920-735-4134  
International FAX: 920-735-4125

For International Locations Visit  
[www.MillerWelds.com](http://www.MillerWelds.com)

