



OM-217 741J

2010-10

## Auto-Darkening Helmets Model: Elite™



To help us serve you better, go to [www.MillerWelds.Com/HelmetReg/](http://www.MillerWelds.Com/HelmetReg/)

# TABLE OF CONTENTS

---

<b>SECTION 1 – WELDING HELMET SAFETY PRECAUTIONS –READ BEFORE USING</b>	<b>1</b>
1-1. Symbol Usage .....	1
1-2. Arc Welding Hazards .....	1
<b>SECTION 2 – SPECIFICATIONS</b> .....	<b>3</b>
<b>SECTION 3 – OPERATING INSTRUCTIONS</b> .....	<b>4</b>
3-1. Helmet Controls .....	4
3-2. Reset Button And Low Battery Indicator .....	5
3-3. Lens Delay Control .....	5
3-4. Variable Shade Control (No. 8 – 13) .....	6
3-5. Sensitivity Control .....	7
<b>SECTION 4 – ADJUSTING HEADGEAR</b> .....	<b>8</b>
<b>SECTION 5 – REPLACING THE LENS COVERS</b> .....	<b>9</b>
5-1. Replacing Lens Covers On Standard Helmets .....	9
5-2. Replacing Lens Covers On Quick Release Helmets .....	10
<b>SECTION 6 – REPLACING THE BATTERY</b> .....	<b>11</b>
<b>SECTION 7 – INSTALLING OPTIONAL MAGNIFYING LENS</b> .....	<b>12</b>
<b>SECTION 8 – MAINTENANCE</b> .....	<b>12</b>
<b>SECTION 9 – TROUBLESHOOTING</b> .....	<b>13</b>
<b>SECTION 10 – PARTS LIST</b> .....	<b>14</b>
<b>SECTION 11 – LIMITED WARRANTY</b> .....	<b>17</b>

# SECTION 1 – WELDING HELMET SAFETY PRECAUTIONS – READ BEFORE USING

helmet 2010-03

 **Protect yourself and others from injury — read and follow these precautions.**

## 1-1. Symbol Usage



**DANGER!** – Indicates a hazardous situation which, if not avoided, will result in death or serious injury. The possible hazards are shown in the adjoining symbols or explained in the text.

 Indicates special instructions.



Indicates a hazardous situation which, if not avoided, could result in death or serious injury. The possible hazards are shown in the adjoining symbols or explained in the text.

This group of symbols means Warning! Watch Out! ELECTRIC SHOCK, MOVING PARTS, and HOT PARTS hazards. Consult symbols and related instructions below for necessary actions to avoid the hazards.

**NOTICE** – Indicates statements not related to personal injury.

## 1-2. Arc Welding Hazards

 **Only qualified persons should install, operate, maintain, and repair this unit.**

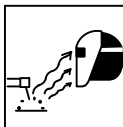

### **ARC RAYS can burn eyes and skin.**

Arc rays from the welding process produce intense visible and invisible (ultraviolet and infrared) rays that can burn eyes and skin. Sparks fly off from the weld.

- Wear a welding helmet fitted with a proper shade of filter to protect your face and eyes when welding or watching (see ANSI Z49.1 and Z87.1 listed in Safety Standards). Refer to Shade and Sensitivity charts.
- Wear approved safety glasses with side shields under your helmet.
- Use protective screens or barriers to protect others from flash, glare, and sparks; warn others not to watch the arc.
- Wear protective clothing made from durable, flame-resistant material (leather, heavy cotton, and wool) and foot protection.
- Before welding, adjust the auto-darkening lens sensitivity setting to meet the application.
- Stop welding immediately if the auto-darkening lens does not darken when the arc is struck. See the Owner's Manual for more information.



### **WELDING HELMETS do not provide unlimited eye, ear and face protection.**

Arc rays from the welding process produce intense visible and invisible (ultraviolet and infrared) rays that can burn eyes and skin. Sparks fly off from the weld.

- Use impact resistant safety spectacles or goggles and ear protection at all times when using this welding helmet.
- Do not use this helmet while working with or around explosives or corrosive liquids.
- Do not weld in the overhead position while using this helmet.
- Inspect the auto-lens frequently. Immediately replace any scratched, cracked, or pitted cover lenses or auto-lenses.



## **NOISE can damage hearing.**

Noise from some processes or equipment can damage hearing.

- Wear approved ear protection if noise level is high.

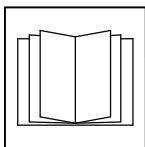

## **READ INSTRUCTIONS.**

- Read and follow all labels and the Owner's Manual carefully before installing, operating, or servicing unit. Read the safety information at the beginning of the manual and in each section.

- Use only genuine replacement parts from the manufacturer.
- Perform maintenance and service according to the Owner's Manuals, industry standards, and national, state, and local codes.



## **FUMES AND GASES can be hazardous.**

Welding produces fumes and gases. Breathing these fumes and gases can be hazardous to your health.

- Keep your head out of the fumes. Do not breathe the fumes.
- If inside, ventilate the area and/or use local forced ventilation at the arc to remove welding fumes and gases.
- If ventilation is poor, wear an approved air-supplied respirator.
- Read and understand the Material Safety Data Sheets (MSDSs) and the manufacturer's instructions for metals, consumables, coatings, cleaners, and degreasers.
- Work in a confined space only if it is well ventilated, or while wearing an air-supplied respirator. Always have a trained watchperson nearby. Welding fumes and gases can displace air and lower the oxygen level causing injury or death. Be sure the breathing air is safe.
- Do not weld in locations near degreasing, cleaning, or spraying operations. The heat and rays of the arc can react with vapors to form highly toxic and irritating gases.
- Do not weld on coated metals, such as galvanized, lead, or cadmium plated steel, unless the coating is removed from the weld area, the area is well ventilated, and while wearing an air-supplied respirator. The coatings and any metals containing these elements can give off toxic fumes if welded.

## **1-3. Proposition 65 Warnings**



**Welding or cutting equipment produces fumes or gases which contain chemicals known to the State of California to cause birth defects and, in some cases, cancer. (California Health & Safety Code Section 25249.5 et seq.)**



**This product contains chemicals, including lead, known to the state of California to cause cancer, birth defects, or other reproductive harm. *Wash hands after use.***

## SECTION 2 – SPECIFICATIONS

Viewing Field	97 x 60mm/3.81 x 2.62 in
Reaction Time	1/20,000 sec (0.0000500 sec)
Available Shades	Darkened State: No. 8 – No. 13 / Light State: No. 3 provides continuous UV and IR protection
Sensitivity/Grind Mode Control	Adjusts for varying ambient light and welding arc
Delay Control	Slows lens dark-to-light state between 0.1 and 1.0 seconds
Automatic Power Off	Shuts lens Off 15–20 minutes after last arc is struck
Low Battery Indicator	Red LED light illuminates to indicate 2–3 days remaining battery life
Power Supply	CR2450 Lithium Batteries (Miller Part No. 217 043)
Sensors	Independent/Redundant (Four)
Operating Temperature	14°F to 131°F / –10°C to +55°C  ☞ <i>When stored in extremely cold temperatures, warm helmet to ambient temperature before welding.</i>
Storage Temperature	–4°F to 158°F / –20°C to +70°C  ☞ <i>When stored in extremely cold temperatures, warm helmet to ambient temperature before welding.</i>
Total Weight	510.3g (1lb 2oz.)
Standards	ANSI Z87.1+(2003) and DIN/CSA/TUV
Warranty	2 years from date of purchase (see Section 11)

## SECTION 3 – OPERATING INSTRUCTIONS

### 3-1. Helmet Controls

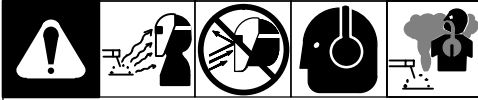

- 1 Reset Button (See Section 3-2)
- 2 Low Battery Indicator (See Section 3-2)
- 3 Variable Shade Control (See Section 3-4)
- 4 Sensitivity Control (See Section 3-5)
- 5 Lens Delay Control (See Section 3-3)

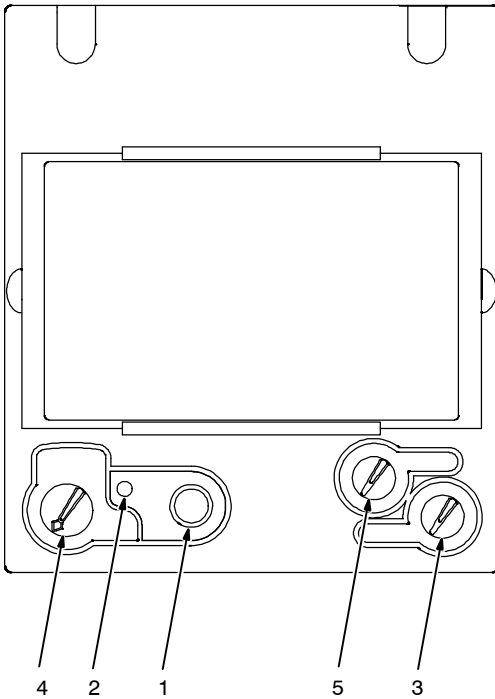

### 3-2. Reset Button And Low Battery Indicator

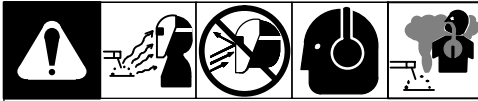

 The auto-darkening lens turns on (darkens) automatically when welding begins and turns off 15 – 20 minutes after welding stops.

#### 1 Reset Button

Press Reset button to check if the lens is working properly.

When the Reset button is pressed, the lens should darken twice and return to the clear state. Do not use the helmet if the lens does not function as described. (See Section 9, Troubleshooting.)

#### 2 Low Battery Indicator

The low battery indicator lights when 2–3 days of battery life remain.

If battery power is low, replace with CR2450 lithium batteries (2 required) (Miller Part No. 217 043) (see Section 6).

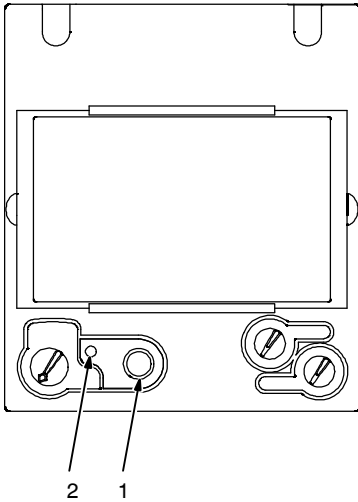

### 3-3. Lens Delay Control



#### 1 Lens Delay Control

The lens delay control is used to adjust the time for the lens to switch to the clear state after welding.

The delay is particularly useful in eliminating bright after-rays present in higher amperage applications where the molten puddle remains bright momentarily after welding. Lens delay adjusts from min (0.10 second) to max (1.0 second.).

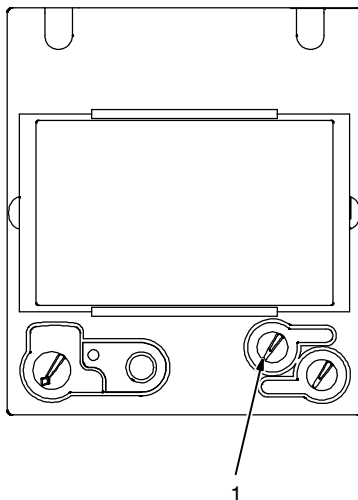

### 3-4. Variable Shade Control (No. 8 – 13)

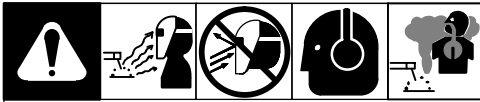

#### 1 Variable Shade Control (No. 8 – 13)

Use the control to adjust the lens shade in the darkened state. Use the table below to select proper shade control setting based on your welding process.

Start at shade 12 and adjust lighter to suit the welding application and your personal preference.

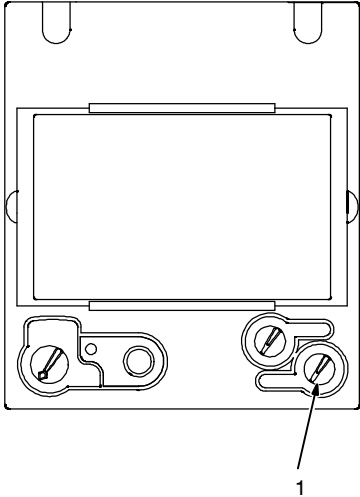

Application Welding	Arc Current in Amperes	Protective Shade No.
Stick Electrodes	Less than 40	9
	40–80	10
	80–175	11
	175–300	12
	300–500	13
MIG	Less than 100	10
	100–175	11
	175–300	12
	300–500	13
Gas Tungsten Arc Welding (TIG)	Less than 50	10
	50–100	11
	100–200	12
	200–400	13
Air Carbon	Less than 500	12
	500–700	13
Plasma Arc Cutting	60–150	11
	150–250	12
	250–400	13
Plasma Arc Welding	Less than 50	9
	50–200	10
	200–400	12



### 3-5. Sensitivity Control

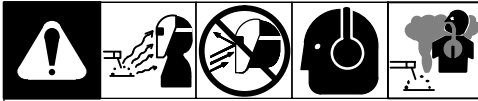

#### 1 Sensitivity Control

##### Weld Mode

Use control to make the lens more responsive to different light levels in various welding processes. **Use a Mid-Range or 30–50% sensitivity setting for most applications.**

It may be necessary to adjust helmet sensitivity to accommodate different lighting conditions or if lens is flashing On and Off. Adjust helmet sensitivity as follows:

 *Adjust helmet sensitivity in lighting conditions helmet will be used in.*

- Turn sensitivity control to lowest setting.
- Press Reset button to turn helmet On. Helmet lens will darken twice and then clear.
- Face the helmet in the direction of use, exposing it to the surrounding light conditions.
- Gradually turn sensitivity setting clockwise until the lens darkens, then turn sensitivity control counterclockwise until slightly past setting where lens clears. Helmet is ready for use. Slight readjustment may be necessary for certain applications or if lens is flashing on and off.

##### Grind Mode

 *Do not weld in the Grind mode; the lens will not darken.*

To use the Grind mode, turn the Sensitivity control clockwise to the far right position (Grind). To resume welding, return the control to the desired sensitivity setting.

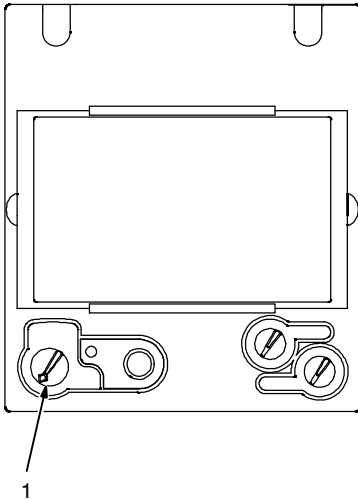

### Recommended Sensitivity Settings

Stick Electrode	Mid-Range
Short Circuiting (MIG)	Low/Mid-Range
Pulsed & Spray (MIG)	Mid-Range
Gas Tungsten Arc (TIG)	Mid/High-Range
Plasma Arc Cutting/Welding	Low/Mid-Range
Grind Mode	Grind Position – Far Right (Clockwise)

## SECTION 4 – ADJUSTING HEADGEAR

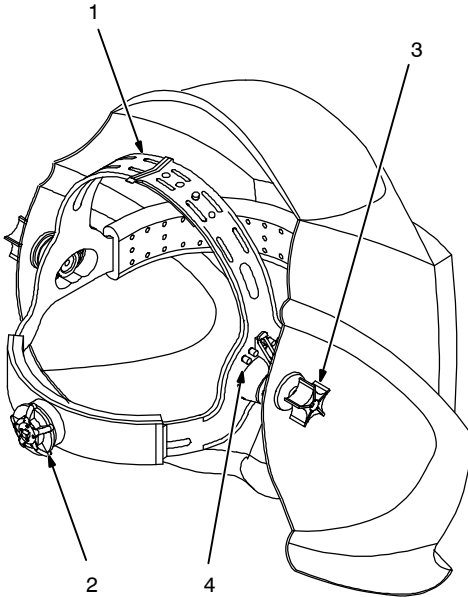
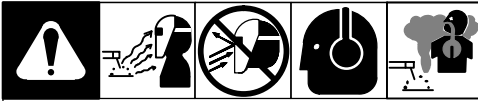

☞ *There are four headgear adjustments: headgear top, tightness, angle adjustment, and distance adjustment.*

### 1 Headgear Top

Adjusts headgear for proper depth on the head to ensure correct balance and stability.

### 2 Headgear Tightness

To adjust, push in the adjusting knob located on the back of the headgear and turn left or right to desired tightness.

☞ *If adjustment is limited, it may be necessary to remove the comfort cushion.*

### 3 Distance Adjustment

Adjusts the distance between the face and the lens. To adjust, loosen both outside tension knobs and press inward to free from adjustment slots. Move forward or back to desired position and retighten. (Both sides must be equally positioned for proper vision.)

### 4 Angle Adjustment

Four pins on the right side of the headband top provide adjustment for the forward tilt of the helmet. To adjust, loosen the right outside tension adjustment knob then lift on the control arm tab and move it to the desired position. Retighten tension adjustment knob.

☞ *When using the back distance adjustment positions, only the back three angle adjustment pins can be used.*

## SECTION 5 – REPLACING THE LENS COVERS

### 5-1. Replacing The Lens Covers On Standard Helmets

Be sure wide edge of gasket faces helmet shell.

Be sure flat side of gasket faces helmet shell.

1 Front Lens Gasket

2 Outside Lens Cover

3 Lens Assembly Gasket

4 Lens Assembly

5 Inside Lens Cover

6 Lens Frame

**⚠** Never use the auto-darkening lens without the inside and outside lens covers properly installed. Welding spatter will damage the auto-darkening lens and void the warranty.

Remove the lens assembly to remove either lens cover.

To remove the lens assembly, push down on the helmet bottom retaining arms and push the retaining clips toward the outside of the helmet. Lift up on the assembly and pull free of the helmet.

**Outside Lens Cover**

Remove the outside lens cover by pushing cover into the helmet. Remove the rubber lens gasket and install on the new lens cover. Reinstall the lens assembly.

**Inside Lens Cover**

To replace the inside lens cover, remove the lens assembly from the helmet by pushing up on the top two retaining tabs while gently pushing the lens free.

Remove the lens cover by sliding it out of either side. Replace with the new cover lens and reinstall the assembly in the helmet.

Ref. 805 012

**☞** Be sure the flat side of lens cover gasket faces the helmet shell.

## 5-2. Replacing Lens Covers On Quick Release Helmets

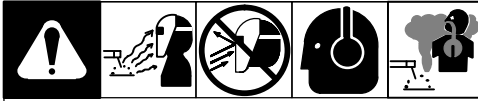

**⚠** Never use the auto-darkening lens without the inside and outside lens covers properly installed. Welding spatter will damage the auto-darkening lens and void the warranty.

- 1 Front Lens Holder
- 2 Release Points
- 3 Lens Cover

Remove front lens holder by pressing release points and pulling the holder away from the helmet.

Remove lens cover from the holder. Replace lens cover in holder. Reinstall holder in helmet.

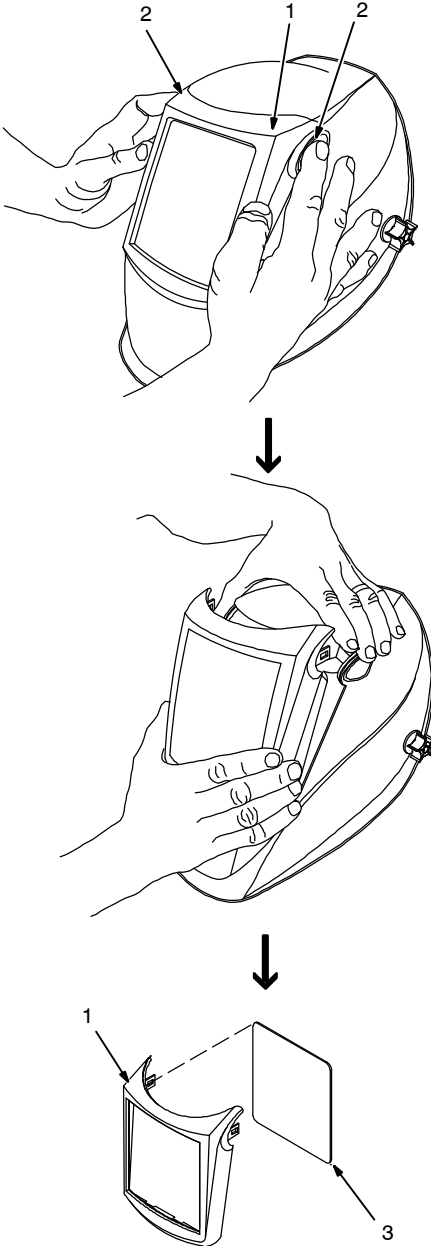

8804 814 / 804 816

## SECTION 6 – REPLACING THE BATTERY

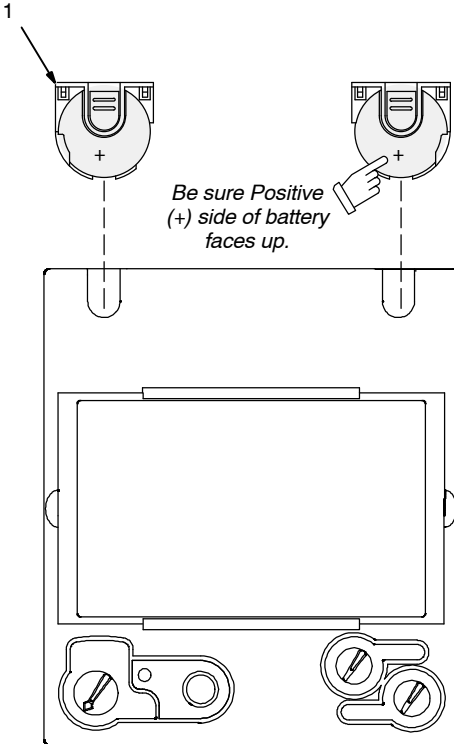
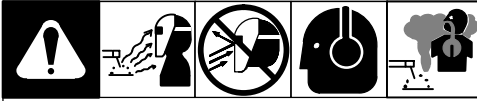

To replace the batteries, remove the auto-darkening lens assembly (see Section 5).

### 1 Battery Tray

After removing the lens assembly, slide the battery holding trays out and remove the old batteries.

Replace with CR2450 lithium type batteries (2 required) or equivalent (Miller Part No. 217043).

**Be sure Positive (+) side of the battery faces up (toward inside of helmet).**

Reinstall the battery trays. To test, press the Reset button. The lens should flash dark twice. Reinstall the lens assembly.

**Left and right battery trays are not interchangeable. The auto-darkening helmet will not work if battery trays are installed on the wrong sides.**

## SECTION 7 – INSTALLING OPTIONAL MAGNIFYING LENS

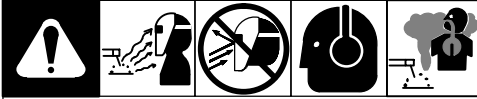

### 1 Optional Magnifying Lens

Starting at the bottom, slide magnifying lens into the helmet retaining brackets. Align the magnifying lens with the auto-darkening lens assembly.

- Remove lens holding frame (with auto-darkening lens) from helmet shell.
- Remove auto-darkening lens from lens holder.
- Position lens holder with magnifying lens holding tabs facing toward you. From the bottom up, slide magnifying lens into position. (Slide magnifying lens up or down slightly as desired.)
- Reinstall the auto-darkening lens in the lens holder.
- Reverse procedure to remove magnifying lens.

 To prevent lens fogging, install flat side of magnifying lens toward auto-darkening lens.

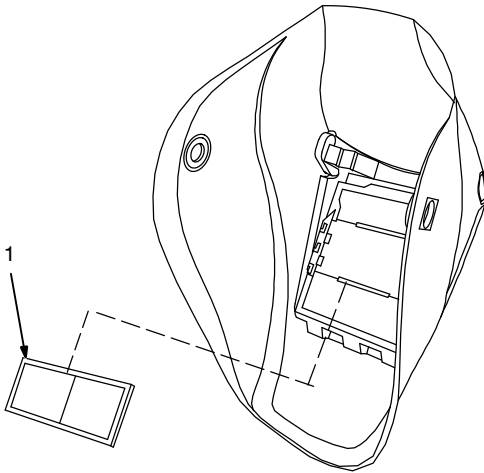

804 818

## SECTION 8 – MAINTENANCE

**NOTICE** – Never use solvents or abrasive cleaning detergents.

**NOTICE** – Do not immerse the lens assembly in water.

The helmet requires little maintenance. However, for best performance clean after each use. Using a soft cloth dampened with a mild soap and water solution, wipe the cover lenses clean. Allow to air dry. Occasionally, the filter lens and sensors should be cleaned by gently wiping with a soft, dry cloth.

## SECTION 9 – TROUBLESHOOTING



Trouble	Remedy
Auto lens not ON – auto-lens will not darken momentarily when the Reset button is pressed.	Check batteries and verify they are in good condition and installed properly. Also, check battery surfaces and contacts and clean if necessary. Check battery for proper contact and gently adjust contact points if necessary. This is particularly important if the helmet has been dropped. Verify left and right battery trays are installed on the correct sides.
Not switching – auto-lens stays light and will not darken when welding.	Stop welding immediately; Press the Reset button if lens is Auto-On type. If lens is Manual-On type, make sure the lens is turned On. If power is on, review the sensitivity recommendations and adjust sensitivity. Clean lens cover and sensors of any obstructions. Make sure the sensors are facing the arc; angles of 45° or more may not allow the arc light to reach the sensors.
Not Switching – auto-lens stays dark after the weld arc is extinguished, or the auto-lens stays dark when no arc is present.	Fine-tune the sensitivity setting by making small adjustments to the control by turning it toward the “min” setting. In extreme light conditions, it may be necessary to reduce the surrounding light levels.
Sections of the auto-lens are not going dark, distinct lines separate the light and dark areas.	Stop welding immediately: The auto-lens may be cracked which can be caused by the impact of dropping the helmet. Weld spatter on the auto lens may also cause cracking. (The lens may need to be replaced; most cracked lenses are not covered by warranty).
Switching or Flickering – the auto-lens darkens then lightens while the welding arc is present.	Review the sensitivity setting recommendations and increase the sensitivity if possible. Be sure the arc sensors are not being blocked from direct access to the arc light. Check the lens cover for dirt and spatter that may be blocking the arc sensors. Increasing Lens Delay 0.1 – 0.3 second may also reduce switching.
Inconsistent or lighter auto-lens shading in the dark-state, noticeable on the outside edges and corners.	Referred to as an angle of view effect, auto-darkening lenses have an optimum viewing angle. The optimum viewing angle is perpendicular or 90° to the surface of the auto-lens. When that angle of view varies in the dark-state, welders may notice slightly lighter areas at the outside edges and the corners of the lens. This is normal and does not represent any health or safety hazard. This effect may also be more noticeable in applications where magnifying lenses are used.

## SECTION 10 – PARTS LIST

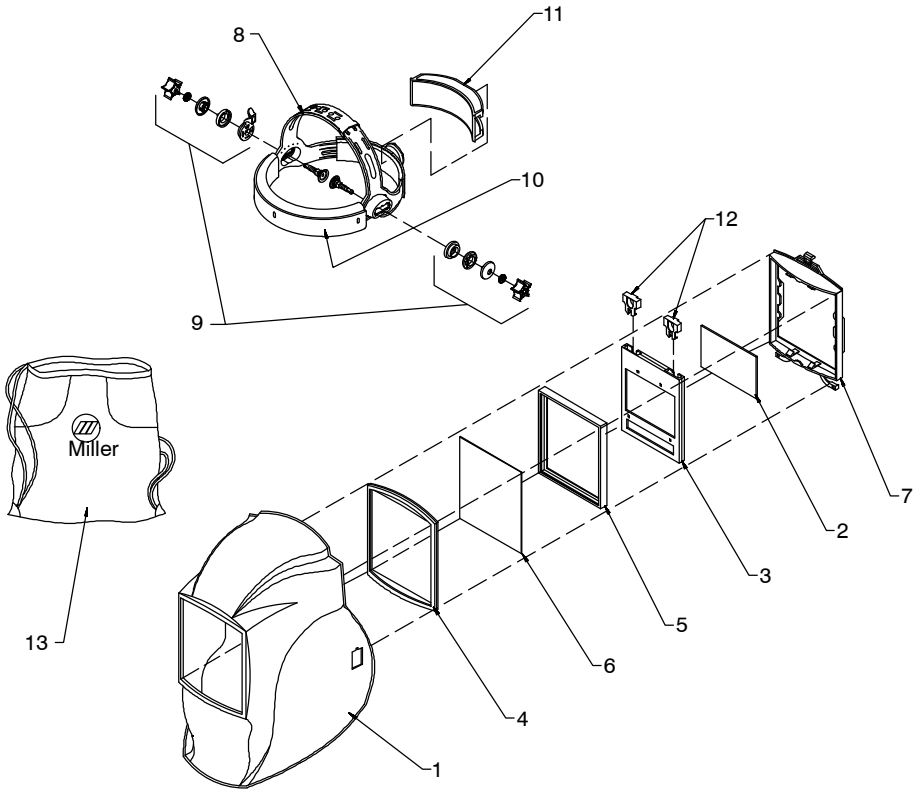

804 111

**Figure 10-1. Elite Series Auto-Darkening Welding Helmet – Standard Models**



Item No.	Part No.	Description	Quantity
<b>Figure 10-1. Elite Series Auto-Darkening Welding Helmet – Standard Models</b>			
1	216 331	Helmet Shell, Black	1
1	227 190	Helmet Shell, Camouflage	1
1	245 136	Helmet Shell, Hockey Canada	1
1	223 454	Helmet Shell, Inferno	1
1	237 872	Helmet Shell, Lucky's Speed Shop	1
1	223 456	Helmet Shell, OCC Paul Jr	1
1	250 089	Helmet Shell, Sinister	1
1	234 066	Helmet Shell, Stars And Stripes	1
1	227 189	Helmet Shell, The Joker	1
1	229 366	Helmet Shell, UA-series 1	1
1	237 159	Helmet Shell, Vintage USA	1
1	241 465	Helmet Shell, Wicked	1
2	216 327	Inside Lens Cover (4-1/4 X 2-1/2) (5 Per Pkg.)	1
3	248 728	Auto-darkening Lens Assembly	1
4	216 337	Gasket, Front Lens – Cover	1
5	234 758	Gasket, Auto-Darkening Lens	1
6	216 326	Outside Lens Cover (4-11/16 X 5-5/8) (5 Per Pkg.)	1
7	234 759	Frame, Lens	1
8	770 246	Ratchet Headgear Assembly (Includes Items 8 And 9)	1
9	**770 248	Adjustment Angle/Stop Hardware Kit	1
10	770 249	Fabric Headband	1
	079 975	Replacement O-rings For Kit 770 248 (5 Per Pkg.)	1
11	216 336	Comfort Cushion, Foam Rubber	1
12	216 339	Battery Tray Kit (Left/Right)	1
	217 043	Battery, Lithium (CR2450)	2
	◆222 003	Hard Hat Adapters (Not Shown)	1
13	770 250	Helmet Bag – Miller	1
	◆212 235	Lens, 0.75 Magnification (Not Shown)	1
	◆212 236	Lens, 1.00 Magnification (Not Shown)	1
	◆212 237	Lens, 1.25 Magnification (Not Shown)	1
	◆212 238	Lens, 1.50 Magnification (Not Shown)	1
	◆212 239	Lens, 1.75 Magnification (Not Shown)	1
	◆212 240	Lens, 2.00 Magnification (Not Shown)	1
	◆212 241	Lens, 2.25 Magnification (Not Shown)	1
	◆212 242	Lens, 2.50 Magnification (Not Shown)	1

\*\* Adjustment Hardware Kit With O-rings.

◆ Optional

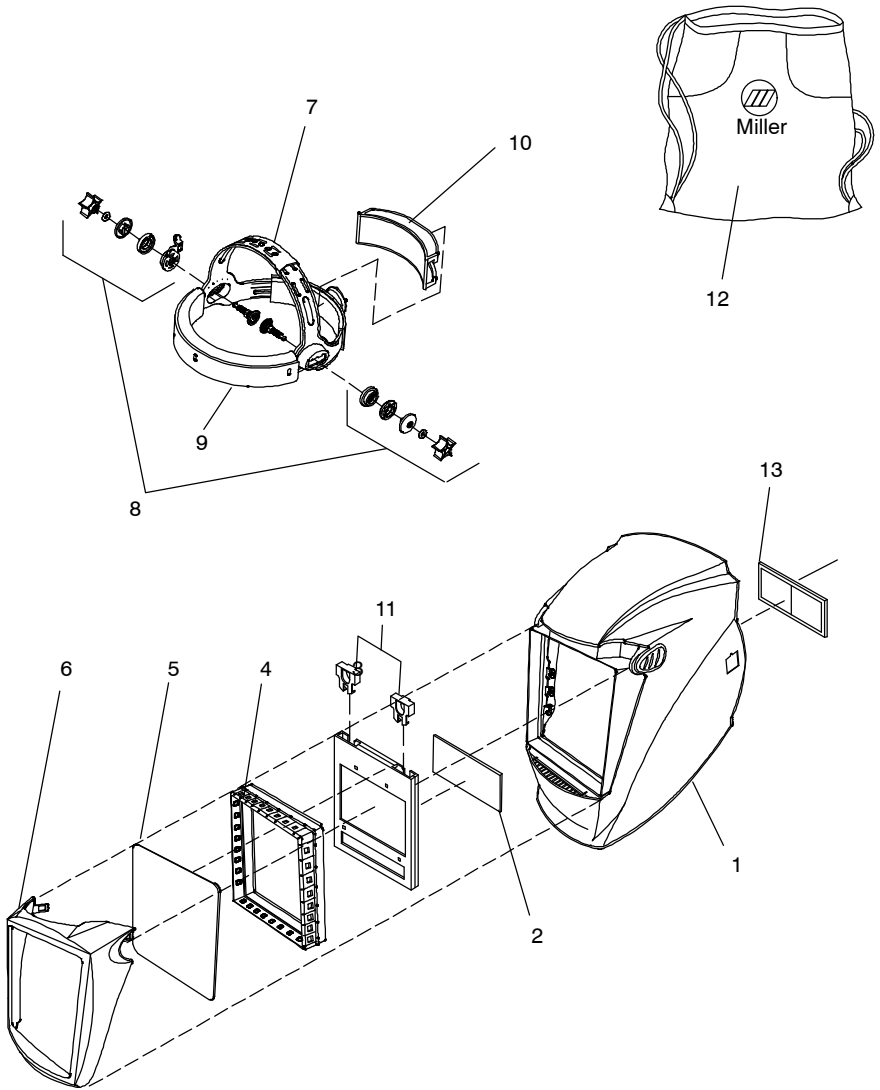

242 385 / Ref. 804 111

**Figure 10-2. Elite Series Auto-Darkening Welding Helmet – Quick Release Models**

Item No.	Part No.	Description	Quantity
----------	----------	-------------	----------

**Figure 10-2. Elite Series Auto-Darkening Welding Helmet – Quick Release Models**

1	241 976	Helmet Shell, Black (Includes Item 6)	1
1	234 938	Helmet Shell, Titanium (Includes Item 6)	1
2	216 327	Inside Lens Cover (4-1/4 X 2-1/2) (5 Per Pkg.)	1
3	248 728	Auto-darkening Lens Assembly	1
4	241 977	Gasket, Lens Assembly	1
5	216 326	Outside Lens Cover (4-11/16 X 5-5/8) (5 Per Pkg.)	1
6	241 978	Front Lens Holder (Black)	1
6	242 204	Front Lens Holder (Titanium)	1
7	770 246	Ratchet Headgear Assembly (Includes Items 8 And 9)	1
8	**770 248	Adjustment Angle/Stop Hardware Kit	1
9	770 249	Fabric Headband	1
	079 975	Replacement O-rings For Kit 770 248 (5 Per Pkg.)	1
10	216 336	Comfort Cushion, Foam Rubber	1
11	216 339	Battery Tray Kit (Left/Right)	1
	217 043	Battery, Lithium (CR2450)	2
	◆222 003	Hard Hat Adapters (Not Shown)	1
12	770 250	Helmet Bag – Miller	1
13	◆212 235	Lens, 0.75 Magnification (Not Shown)	1
	◆212 236	Lens, 1.00 Magnification (Not Shown)	1
	◆212 237	Lens, 1.25 Magnification (Not Shown)	1
	◆212 238	Lens, 1.50 Magnification (Not Shown)	1
	◆212 239	Lens, 1.75 Magnification (Not Shown)	1
	◆212 240	Lens, 2.00 Magnification (Not Shown)	1
	◆212 241	Lens, 2.25 Magnification (Not Shown)	1
	◆212 242	Lens, 2.50 Magnification (Not Shown)	1

\*\* Adjustment Hardware Kit With O-rings.

◆ Optional

## SECTION 11 – LIMITED WARRANTY

**LIMITED WARRANTY** – Subject to the terms and conditions below. Miller Electric Mfg. Co., Appleton, Wisconsin, warrants to its original retail purchaser that the new Miller equipment sold after the effective date of this limited warranty is free of defects in material and workmanship at the time it is shipped by Miller. THIS WARRANTY IS EXPRESSLY IN LIEU OF ALL OTHER WARRANTIES, EXPRESS OR IMPLIED, INCLUDING THE WARRANTIES OR MERCHANTABILITY AND FITNESS.

Miller Elite Series auto-darkening lens helmets are warranted for 2 years from the date of purchase. *Proof of purchase is required for warranty transactions so it is imperative that a copy of the original invoice or sales receipt be retained.*

**For warranty transactions, contact your Miller Distributor.**

Effective January 1, 2010



Visit our website at  
**[www.MillerWelds.com](http://www.MillerWelds.com)**



**Miller Electric Mfg. Co.**  
An Illinois Tool Works Company  
1635 West Spencer Street  
Appleton, WI 54914 USA