



OM-269 681A

2015-03

# Auto-Darkening Helmets

## Model: Infinity Series w/Infotrack™

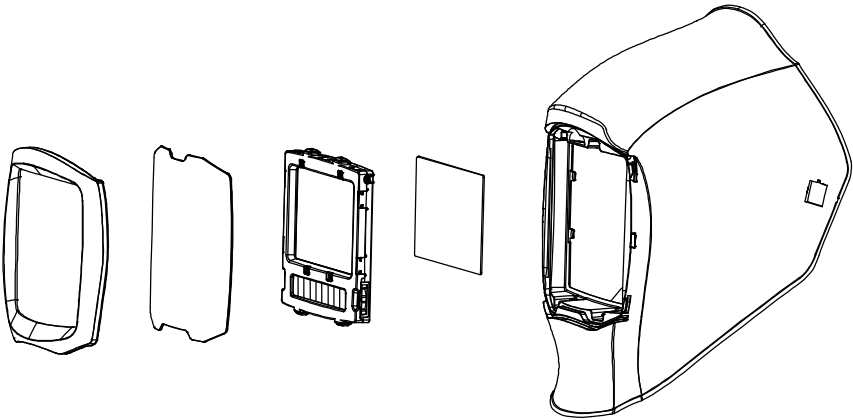

To help us serve you better, go to [www.MillerWelds.Com/Register](http://www.MillerWelds.Com/Register)

# TABLE OF CONTENTS

---

<b>SECTION 1 – WELDING HELMET SAFETY PRECAUTIONS –READ BEFORE USING</b> . . . . .	<b>1</b>
1-1. Symbol Usage . . . . .	1
1-2. Arc Welding Hazards . . . . .	1
1-3. Proposition 65 Warnings . . . . .	3
1-4. Lens Shade Selection Table . . . . .	3
1-5. Principal Safety Standards . . . . .	3
<b>SECTION 2 – SPECIFICATIONS</b> . . . . .	<b>5</b>
<b>SECTION 3 – OPERATING INSTRUCTIONS</b> . . . . .	<b>6</b>
3-1. Helmet Controls . . . . .	6
3-2. Auto On/Off Button And Grind Mode/Low Battery Light . . . . .	7
3-3. Mode Control Button . . . . .	8
3-4. Variable Shade Control . . . . .	9
3-5. Lens Delay Control . . . . .	10
3-6. Sensitivity Control . . . . .	11
3-7. Typical Lens Adjustment Procedure . . . . .	12
3-8. Info Control Button . . . . .	13
3-9. Arc Time Control . . . . .	14
3-10. Clock Control . . . . .	15
3-11. Timer Control . . . . .	16
3-12. Alarm Control . . . . .	17
3-13. Setting Help Menu Language And Viewing Help Menu . . . . .	18
<b>SECTION 4 – ADJUSTING HEADGEAR</b> . . . . .	<b>19</b>
4-1. Adjusting Headgear . . . . .	19
<b>SECTION 5 – REPLACING THE GRINDING SHIELD OR LENS COVERS</b> . . . . .	<b>20</b>
5-1. Replacing Lens Covers . . . . .	20
<b>SECTION 6 – REPLACING THE BATTERY (AUTO-DARKENING LENS ASSEMBLIES)</b> . . . . .	<b>21</b>
6-1. Replacing The Batteries . . . . .	21
<b>SECTION 7 – INSTALLING OPTIONAL MAGNIFYING LENS</b> . . . . .	<b>22</b>
<b>SECTION 8 – MAINTENANCE</b> . . . . .	<b>22</b>
<b>SECTION 9 – TROUBLESHOOTING</b> . . . . .	<b>23</b>
<b>SECTION 10 – PARTS LIST</b> . . . . .	<b>24</b>
<b>SECTION 11 – LIMITED WARRANTY</b> . . . . .	<b>25</b>

# SECTION 1 – WELDING HELMET SAFETY PRECAUTIONS – READ BEFORE USING

helmet 2013-09

-  **Protect yourself and others from injury — read, follow, and save these important safety precautions and operating instructions.**

## 1-1. Symbol Usage



**DANGER!** – Indicates a hazardous situation which, if not avoided, will result in death or serious injury. The possible hazards are shown in the adjoining symbols or explained in the text.

 Indicates special instructions.



Indicates a hazardous situation which, if not avoided, could result in death or serious injury. The possible hazards are shown in the adjoining symbols or explained in the text.

This group of symbols means Warning! Watch Out! ELECTRIC SHOCK, MOVING PARTS, and HOT PARTS hazards. Consult symbols and related instructions below for necessary actions to avoid the hazards.

**NOTICE** – Indicates statements not related to personal injury.

## 1-2. Arc Welding Hazards

-  **Only qualified persons should install, operate, maintain, and repair this unit.**



### **ARC RAYS can burn eyes and skin.**

Arc rays from the welding process produce intense visible and invisible (ultraviolet and infrared) rays that can burn eyes and skin. Sparks fly off from the weld.

- Wear a welding helmet fitted with a proper shade of filter to protect your face and eyes when welding or watching (see ANSI Z49.1 and Z87.1 listed in Safety Standards). Refer to Lens Shade Selection table in Section 1-4.
- Wear approved safety glasses with side shields under your helmet.
- Use protective screens or barriers to protect others from flash, glare, and sparks; warn others not to watch the arc.
- Wear body protection made from durable, flame-resistant material (leather, heavy cotton, wool). Body protection includes oil-free clothing such as leather gloves, heavy shirt, cuffless trousers, high shoes, and a cap.
- Before welding, adjust the auto-darkening lens sensitivity setting to meet the application.
- Stop welding immediately if the auto-darkening lens does not darken when the arc is struck. See the Owner's Manual for more information.

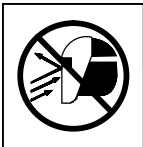

## **WELDING HELMETS do not provide unlimited eye, ear, and face protection.**

Arc rays from the welding process produce intense visible and invisible (ultraviolet and infrared) rays that can burn eyes and skin. Sparks fly off from the weld.

- Use impact resistant safety spectacles or goggles and ear protection at all times when using this welding helmet.
- Do not use this helmet while working with or around explosives or corrosive liquids.
- Do not weld in the overhead position while using this helmet.
- Inspect the auto-lens frequently. Immediately replace any scratched, cracked, or pitted cover lenses or auto-lenses.

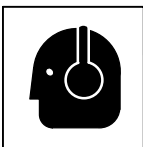

## **NOISE can damage hearing.**

Noise from some processes or equipment can damage hearing.

- Wear approved ear protection if noise level is high.

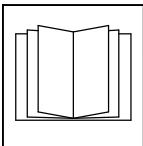

## **READ INSTRUCTIONS.**

- Read and follow all labels and the Owner's Manual carefully before installing, operating, or servicing unit. Read the safety information at the beginning of the manual and in each section.

- Use only genuine replacement parts from the manufacturer.
- Perform maintenance and service according to the Owner's Manuals, industry standards, and national, state, and local codes.





## **FUMES AND GASES can be hazardous.**

Welding produces fumes and gases. Breathing these fumes and gases can be hazardous to your health.

- Keep your head out of the fumes. Do not breathe the fumes.
- If inside, ventilate the area and/or use local forced ventilation at the arc to remove welding fumes and gases. The recommended way to determine adequate ventilation is to sample for the composition and quantity of fumes and gases to which personnel are exposed.
- If ventilation is poor, wear an approved air-supplied respirator.
- Read and understand the Safety Data Sheets (SDSs) and the manufacturer's instructions for adhesives, coatings, cleaners, consumables, coolants, degreasers, fluxes, and metals.
- Work in a confined space only if it is well ventilated, or while wearing an air-supplied respirator. Always have a trained watchperson nearby. Welding fumes and gases can displace air and lower the oxygen level causing injury or death. Be sure the breathing air is safe.
- Do not weld in locations near degreasing, cleaning, or spraying operations. The heat and rays of the arc can react with vapors to form highly toxic and irritating gases.
- Do not weld on coated metals, such as galvanized, lead, or cadmium plated steel, unless the coating is removed from the weld area, the area is well ventilated, and while wearing an air-supplied respirator. The coatings and any metals containing these elements can give off toxic fumes if welded.

## 1-3. Proposition 65 Warnings

 Welding or cutting equipment produces fumes or gases which contain chemicals known to the State of California to cause birth defects and, in some cases, cancer. (California Health & Safety Code Section 25249.5 et seq.)

 This product contains chemicals, including lead, known to the state of California to cause cancer, birth defects, or other reproductive harm. *Wash hands after use.*

## 1-4. Lens Shade Selection Table

Process	Electrode Size in. (mm)	Arc Current in Amperes	Minimum Protective Shade No.	Suggested Shade No. (Comfort)*
Shielded Metal Arc Welding (SMAW)	Less than 3/32 (2.4) 3/32–5/32 (2.4–4.0) 5/32–1/4 (4.0–6.4) More than 1/4 (6.4)	Less than 60	7	--
		60–160	8	10
		160–250	10	12
		250–550	11	14
Gas Metal Arc Welding (GMAW)  Flux Cored Arc Welding (FCAW)		Less than 60	7	--
		60–160	10	11
		160–250	10	12
		250–500	10	14
Gas Tungsten Arc Welding (TIG)		Less than 50	8	10
		50–150	8	12
		150–500	10	14
Air Carbon Arc Cutting (CAC-A)	Light Heavy	Less than 500	10	12
		500–1000	11	14
Plasma Arc Cutting (PAC)		Less than 20	4	4
		20–40	5	5
		40–60	6	6
		60–80	8	8
		80–300	8	9
		300–400	9	12
Plasma Arc Welding (PAW)		Less than 20	6	6–8
		20–100	8	10
		100–400	10	12
		400–800	11	14

Reference: ANSI Z49.1:2005

\* Start with a shade that is too dark to see the weld zone. Then, go to a lighter shade which gives a sufficient view of the weld zone without going below the minimum.

## 1-5. Principal Safety Standards

*Safety in Welding, Cutting, and Allied Processes*, ANSI Standard Z49.1, is available as a free download from the American Welding Society at <http://www.aws.org> or purchased from Global Engineering Documents (phone: 1-877-413-5184, website: [www.global.ihc.com](http://www.global.ihc.com)).

*Safe Practice For Occupational And Educational Eye And Face Protection*, ANSI Standard Z87.1, from American National Standards Institute, 25 West 43rd Street, New York, NY 10036 (phone: 212-642-4900, website: [www.ansi.org](http://www.ansi.org)).



## SECTION 2 – SPECIFICATIONS

Specification	Digital Infinity Helmet
Viewing Field	4.4 x 3.1 in (112 x 78 mm)
Reaction Time	0.0000500 sec (1/20,000)
Available Shades <i>All Shades Provide Continuous UV And IR Protection.</i>	<p><b>Weld Mode</b> Darkened State: No. 8 – No. 13 Light State: No. 3</p> <p><b>Cut Mode</b> Darkened State: No. 5 – No. 8 Light State: No. 3</p> <p><b>Grind Mode</b> Light State: No. 3</p> <p><b>X-Mode</b> Darkened State: No. 8 – No. 13 Light State: No. 3</p>
Sensitivity Control	Adjustable For Varying Ambient Light And Welding Arc
Delay Control	Slows Lens Dark-To-Light State Between 0.1 And 1.0 Seconds
Automatic Power Off	Shuts Lens Off 45 Minutes After Last Arc Is Struck
Low Battery Light	Red Led Illuminates To Indicate 2–3 Days Remaining Battery Life
Power Supply	CR2450 Lithium Batteries (Miller Part No. 217 043)
Sensors	Independent/Redundant (Four)
Operating Temperature	14°F to 131°F / –10°C to +55°C  ☞ <i>When Stored In Extremely Cold Temperatures, Warm Helmet To Ambient Temperature Before Welding.</i>
Storage Temperature	–4°F to 158°F / –20°C to +70°C  ☞ <i>When Stored In Extremely Cold Temperatures, Warm Helmet To Ambient Temperature Before Welding.</i>
Total Weight	23 oz (650 g)
Standards	ANSI Z87.1+(2010) and CSA
Warranty	Three Years From Date Of Purchase (Section 11)

# SECTION 3 – OPERATING INSTRUCTIONS

## 3-1. Helmet Controls

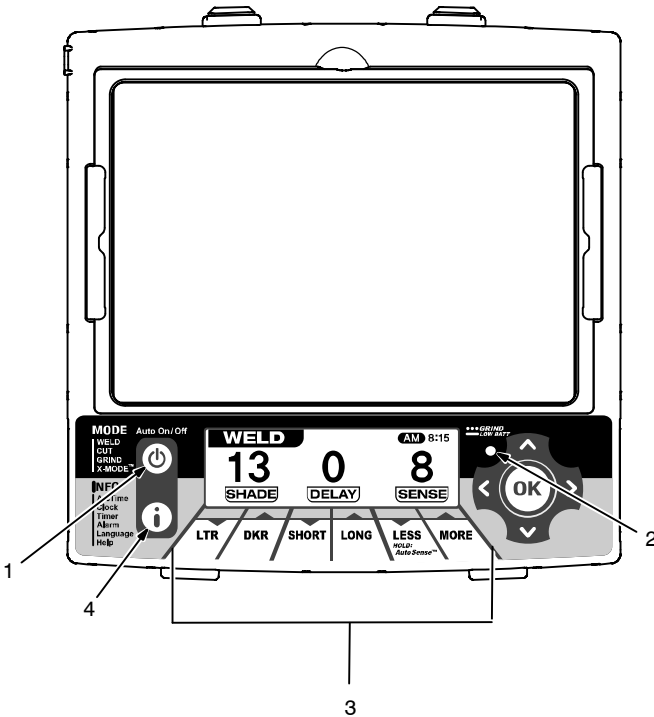
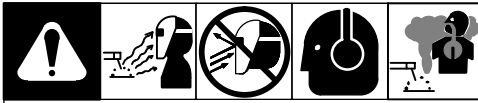

The auto-darkening lens turns on (darkens) automatically when welding begins and turns off when welding stops.

- 1 Auto On/Off Button  
(See Section 3-2)

Mode Control Button  
(Section 3-3)

- 2 Grind Mode/Low Battery Light (Section 3-2)
- 3 Lens/Info Adjustment Buttons (See Sections 3-4 Through 3-6)

 Use adjustment buttons to change shade, delay, and sensitivity settings when lens is in Mode function. Use adjust-

ment buttons to change arc time, clock, timer, alarm, language, and help settings when lens is in Info function.

- 4 Info Control Button  
(See Section 3-8)

 The lens assembly saves the shade, sensitivity, and delay settings.



### 3-2. Auto On/Off Button And Grind Mode/Low Battery Light

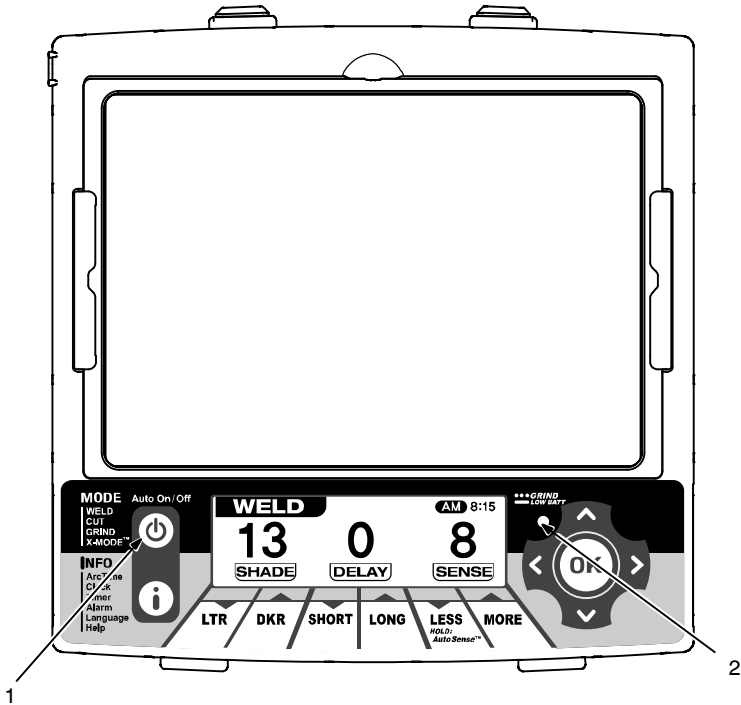
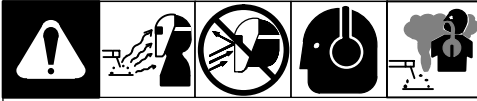

☞ The auto-darkening lens turns on (darkens) automatically when welding begins and turns off when welding stops.

#### 1 Auto On/Off Button

Press Auto On/Off button to check if the lens is working properly and to begin Mode and Info adjustments.

When the Auto On/Off button is pressed, the LCD control panel will turn On.

Press and hold the Auto On/Off button to turn the LCD control panel Off. Lens is on and will function properly.

☞ After four minutes of inactivity, the LCD control panel will turn off automatically to conserve power. Press any button to wake up the LCD control panel.

#### 2 Grind/Low Battery Light

The Grind/Low Battery light blinks when the lens is in the Grind mode. Light stays on when 2–3 days of battery life remain.

If battery power is low, replace with CR2450 lithium batteries (2 required – Miller Part No. 217 043). See Section 6.

### 3-3. Mode Control Button

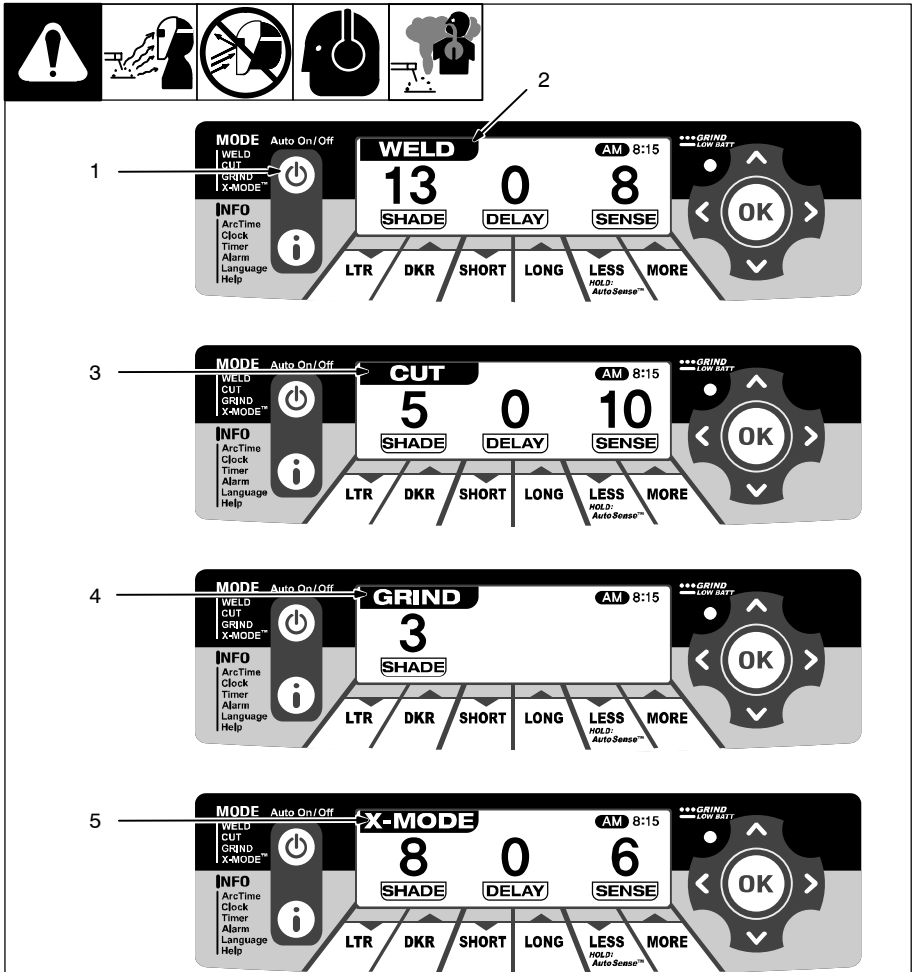

#### 1 Mode Control Button

Press Mode button to select the mode appropriate for the work activity.

#### 2 Weld Mode

Used for most welding applications. In this mode the lens turns on when it optically senses a welding arc. Adjust shade, sensitivity, and delay settings as needed.

#### 3 Cut Mode

Used for cutting applications. In this mode the lens turns on when it optically senses a cutting arc. Adjust shade, sensitivity, and delay settings as needed.

#### 4 Grind Mode

Used for metal grinding applications. In this mode the lens is fixed at shade No. 3. No lens adjustments are possible.

#### 5 X-Mode

Used for outdoor or low current welding applications. In this mode the lens turns on when it senses a welding arc. Adjust shade, sensitivity, and delay settings as needed.

 *Nearby welding may affect helmet operation when lens is in X-Mode. Stay at least 12 ft (3.7 m) away from other welding activity.*

### 3-4. Variable Shade Control

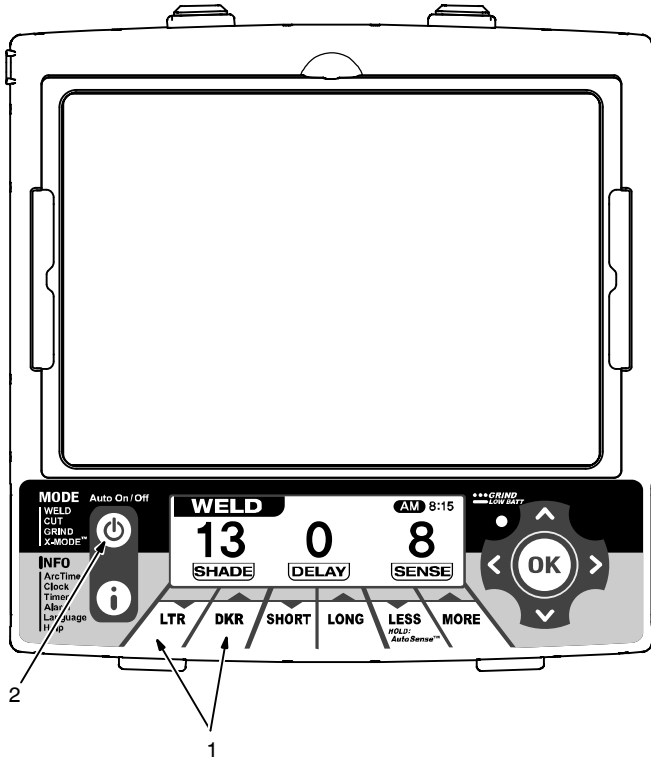

- 1 Variable Shade Adjustment Buttons
- 2 Mode Control Button

Use the LTR and DKR adjustment buttons to adjust the lens shade in the darkened state. Use the table in Section 1-4 to select proper shade control setting based on your welding process. The shade ranges for each mode are as follows:

**Weld** – No. 8 – No. 13  
**Cut** – No. 5 – No. 8

**Grind** – No. 3 only

**X Mode** – No. 8 – No. 13

Start at the highest setting and adjust lighter to suit the application and your personal preference.

#### Variable Shade Adjustment Procedure

- Press Auto On/Off button to turn lens On.

- Press Mode Control Button to select desired function: Weld, Cut, or X-Mode.
- Use LTR and DKR adjustment buttons to select desired shade.
- Begin welding or continue with other lens adjustments.

### 3-5. Lens Delay Control

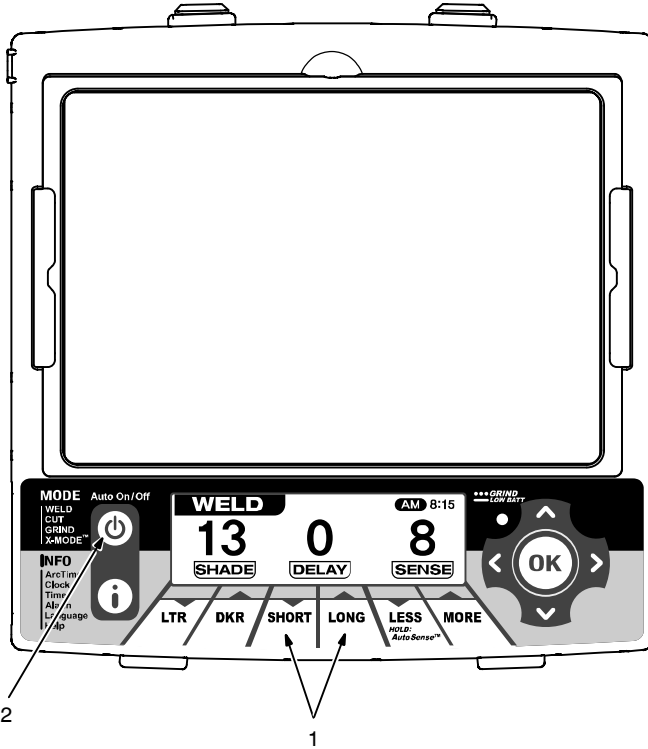
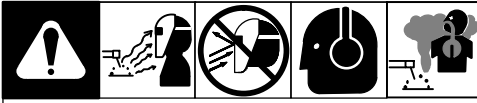

- 1 Lens Delay Adjustment Buttons
- 2 Mode Control Button

Use the Lens Delay Short and Long buttons to adjust the time for the lens to switch to the clear state after welding or cutting.

The delay is particularly useful in eliminating bright after-rays present in higher amperage applications where the molten puddle remains bright momentarily af-

ter welding. Use the Lens Delay Control buttons to adjust delay from 0 to 10 (0.1 to 1.0 second).

The delay ranges for each mode are as follows:

**Weld, Cut, X-Modes** – 0 – 10

**Grind Mode** – No delay adjustment

*There is no lens delay adjustment in the Grind mode.*

#### Lens Delay Adjustment Procedure

- Press Auto On/Off button to turn helmet On.
- Press Mode button to select desired function: Weld, Cut, or X-Mode.
- Use Short and Long adjustment buttons to select desired delay.
- Begin welding or continue with other lens adjustments.

### 3-6. Sensitivity Control

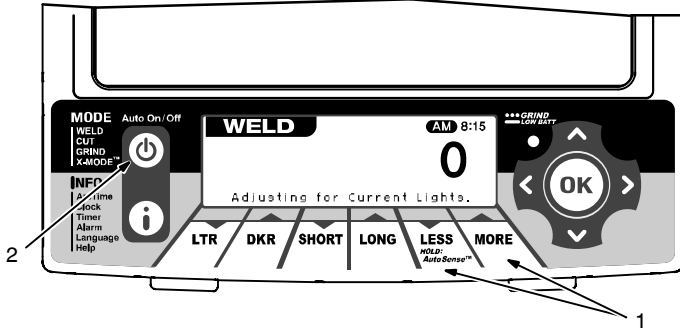

- 1 Sensitivity Adjustment Buttons
- 2 Mode Control Button

Use control to make the lens more responsive to different light levels in various welding processes. **Use a Mid-Range or 30–50% sensitivity setting for most applications.**

It may be necessary to adjust helmet sensitivity to accommodate different lighting conditions or if lens is flashing On and Off.

The sensitivity ranges for each mode are as follows:

**Weld, Cut, X-Modes** – 0 – 10

**Grind Mode** – No sensitivity adjustment

**⚠ Do not weld in the Grind mode. The lens will not darken.**

#### Sensitivity Adjustment Procedure

☞ *Adjust helmet sensitivity in lighting conditions helmet will be used in.*

- Press Auto On/Off button to turn helmet On.
- Press Mode button to select desired function: Weld, Cut, or X-Mode.
- Use Sensitivity Less and More buttons to adjust sensitivity control to lowest setting.
- Face helmet in the direction of use, exposing it to the surrounding light conditions.
- Press Sensitivity More button until the lens darkens, then press Less button until lens clears. An alternative method is to press and hold the Less button until the lens clears.

Helmet is ready for use. Slight readjustment may be necessary for certain applications or if lens is flashing on and off.

☞ *Reduce Sensitivity setting if lens stays dark longer than Delay setting.*

This lens also features AutoSense™, which allows users to push and hold only one button for the lens to adjust sensitivity to the proper setting while in Weld mode.

- To initiate AutoSense, face helmet toward workpiece and push and hold the Less/AutoSense button until screen indicates that it is adjusting.
- Lens will then set to current lighting conditions and can be fine tuned for preference.

#### Recommended Sensitivity Settings

Stick Electrode	Mid-Range
Short Circuiting (MIG)	Low/Mid-Range
Pulsed & Spray (MIG)	Mid-Range
Gas Tungsten Arc (TIG)	Mid/High-Range
Plasma Arc Cutting/Welding	Low/Mid-Range

### 3-7. Typical Lens Adjustment Procedure

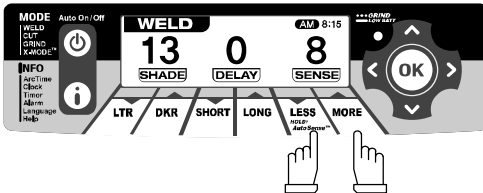
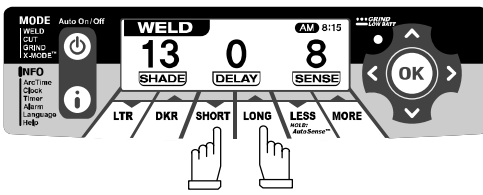
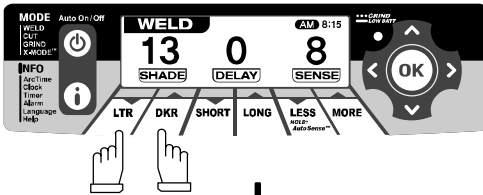
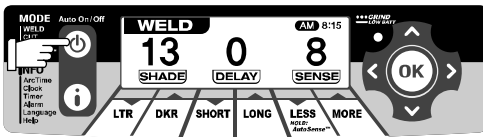
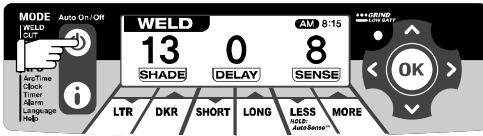
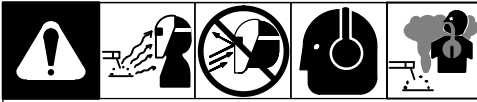

☞ Lens assembly displays prior settings when turned On. Retained settings are not shown in example.

☞ In the Grind mode the lens is a fixed shade No. 3. No lens adjustments are possible.

#### Adjusting Lens Assembly:

- Turn lens On. Display screen appears.
- Select mode (Weld, Cut, Grind, X-Mode).
- Select shade by pressing LTR and DKR buttons.
- Select Delay by pressing Short and Long buttons.
- Select Sensitivity by pressing Less and More Buttons.
- Begin work.

### 3-8. Info Control Button

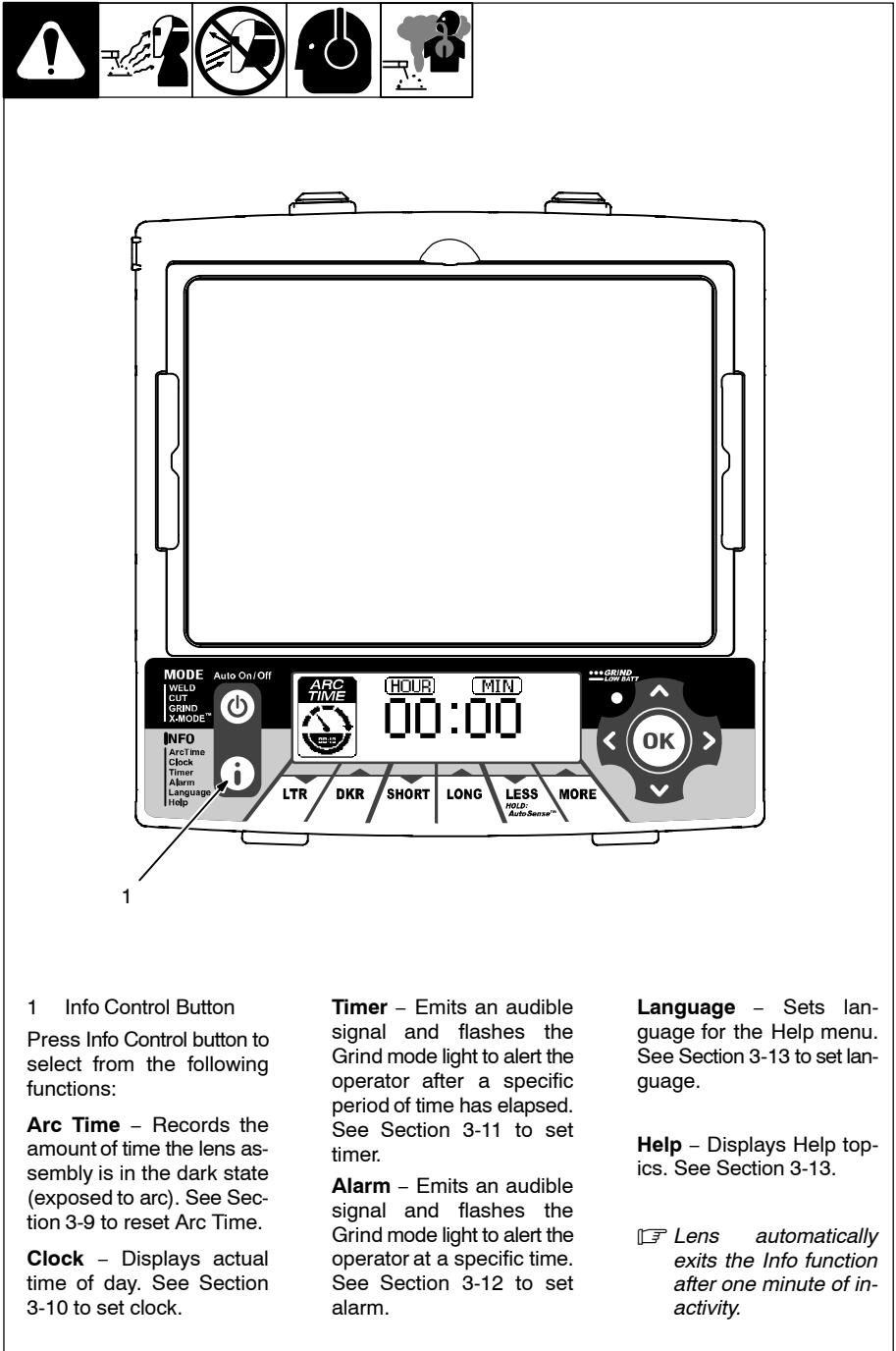

#### 1 Info Control Button

Press Info Control button to select from the following functions:

**Arc Time** – Records the amount of time the lens assembly is in the dark state (exposed to arc). See Section 3-9 to reset Arc Time.

**Clock** – Displays actual time of day. See Section 3-10 to set clock.

**Timer** – Emits an audible signal and flashes the Grind mode light to alert the operator after a specific period of time has elapsed. See Section 3-11 to set timer.

**Alarm** – Emits an audible signal and flashes the Grind mode light to alert the operator at a specific time. See Section 3-12 to set alarm.

**Language** – Sets language for the Help menu. See Section 3-13 to set language.

**Help** – Displays Help topics. See Section 3-13.

*ⓘ Lens automatically exits the Info function after one minute of inactivity.*

### 3-9. Arc Time Control

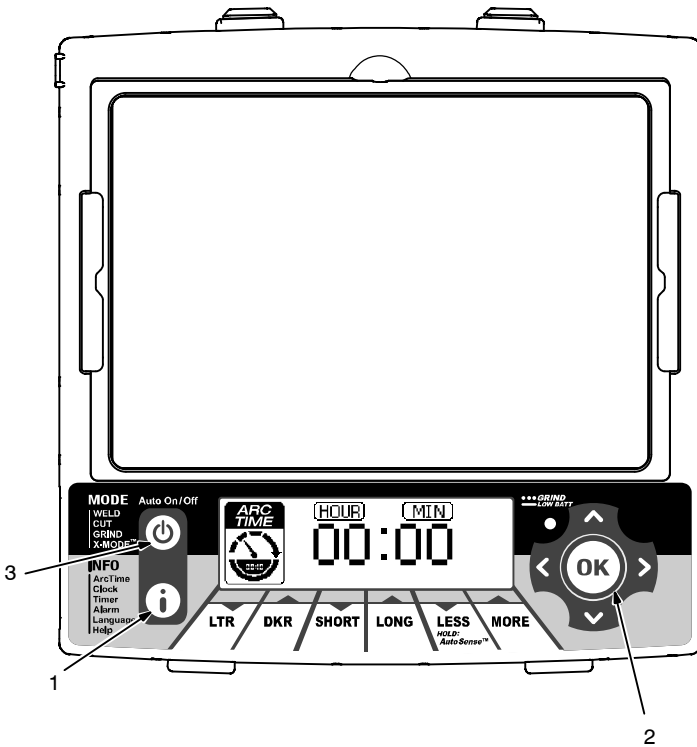
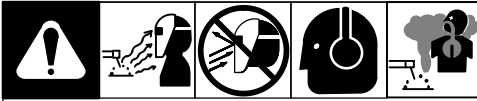

The arc time function records the amount of time the lens assembly is dark (exposed to an arc).

- 1 Info Control Button
- 2 OK Button
- 3 Auto On/Off Button

#### Arc Time Procedure

- Press Auto On/Off button to turn helmet On.
- Press Info Control button repeatedly until Arc Time is displayed on screen.
- Press OK button to clear the arc time to zero.
- Press Auto On/Off button when finished.

 Arc time is accumulated by the second, but only hours and minutes are displayed.



### 3-10. Clock Control

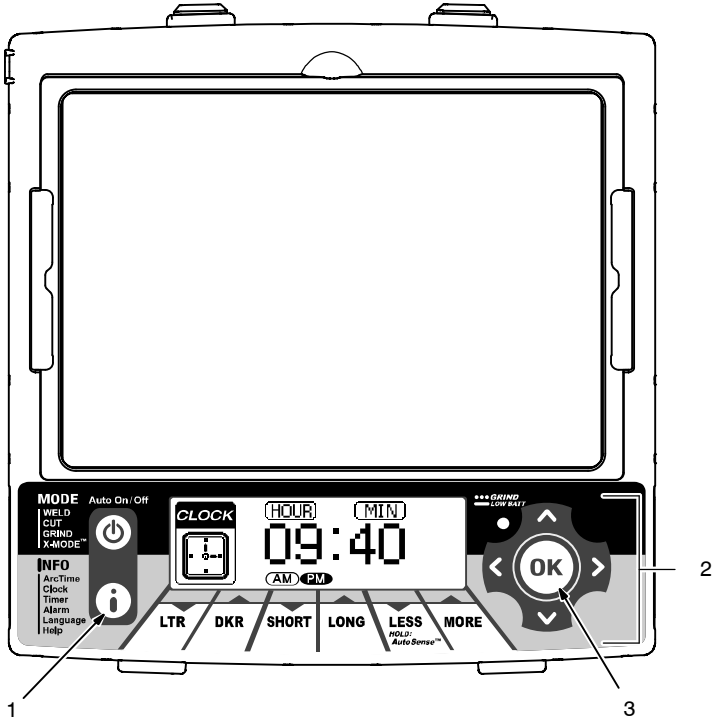
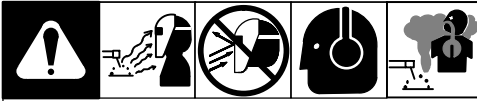

The clock displays the actual time of day.

- 1 Info Control Button
- 2 Directional Buttons
- 3 OK Button

#### Clock Procedure

- Press Auto On/Off button to turn helmet On.
- Press Info button repeatedly until Clock is displayed on screen.
- Use left/right arrows to select hour or minute for adjustment.
- Use up/down arrows to adjust to proper time.
- Press OK to save.
- Press Auto On/Off button when finished.

Adjust the hours to change between a.m. and p.m.

### 3-11. Timer Control

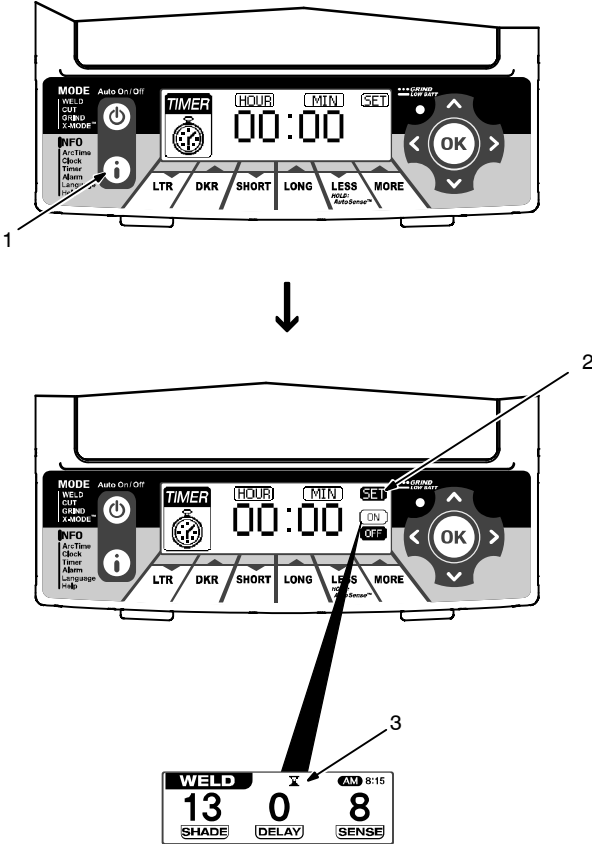
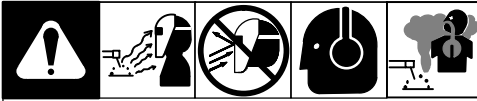

The Timer emits an audible signal and flashes the Grind mode light to alert the operator after a specific period of time has elapsed.

#### 1 Info Control Button

#### Timer Procedure

- Press Auto On/Off button to turn helmet On.
- Press Info Control button repeatedly until

Timer is displayed on screen.

- Use left/right arrows to select hour or minute for adjustment.
  - Use up/down arrows to adjust to desired time.
- 2 Set Selection
- 3 Timer On Indicator
- Use left/right arrows to select Set. Use up/down

arrows to turn timer On/Off.

Times can be saved for future use, but the timer must be turned on to be active.

- Press the OK button to save, or press the Auto On/Off button to exit.

Press any lens button to turn off alarm.

### 3-12. Alarm Control

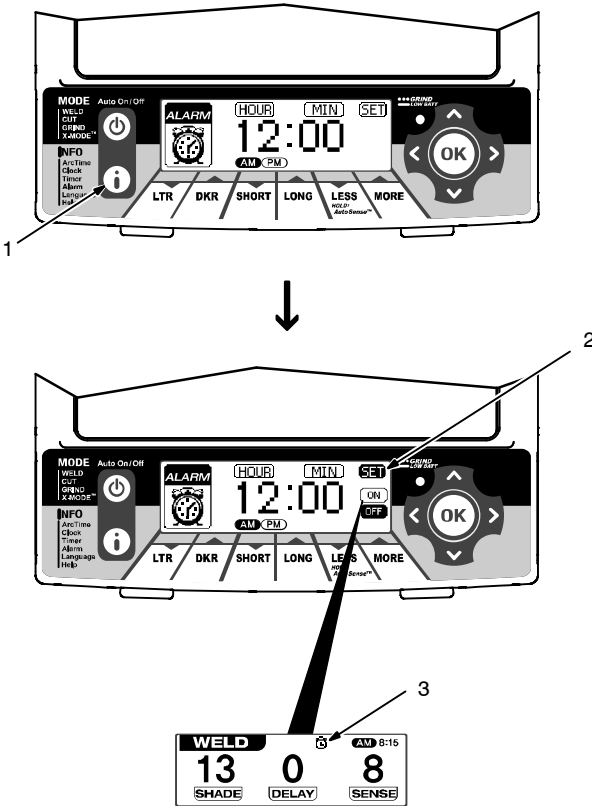
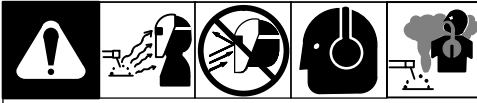

The Alarm emits an audible signal and flashes the Grind mode light to alert the operator at a specific time.

1 Info Control Button

#### Alarm Procedure

- Press Auto On/Off button to turn helmet On.
- Press Info button re-

peatedly until Alarm is displayed on screen.

- Press left/right arrows to select hour or minutes for adjustment
  - Use up/down arrows to adjust to desired time.
- 2 Set Selection
- 3 Alarm On Indicator

- Use left/right arrows to select Set. Use up/down arrows to turn Alarm On/Off.
- Press the OK button to save, or press the Auto On/Off button to exit.

Press any lens button to turn off alarm.

### 3-13. Setting Help Menu Language And Viewing Help Menu

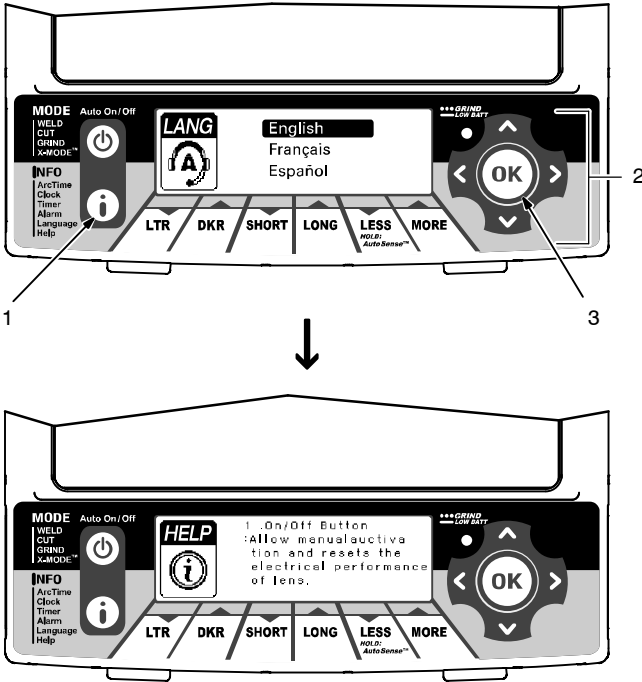
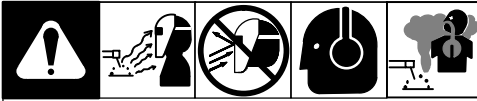

- 1 Info Control Button
- 2 Directional Buttons
- 3 OK Button

- Press Auto On/Off button to turn helmet on.
- Press Info button repeatedly until Language is displayed on screen.

- Use up/down arrows to select desired language. Press OK to save.
- Press the Info Control button once. Help menu will now be shown in the desired language.
- To navigate the Help menu, use either the up/down

down arrows or the left/right arrows. To exit, press the Auto On/Off button.

 Help menu displays abbreviated instructions, modes, and notes on proper usage. Help menu should not be used as a replacement for the full manual.

## SECTION 4 – ADJUSTING HEADGEAR

### 4-1. Adjusting Headgear

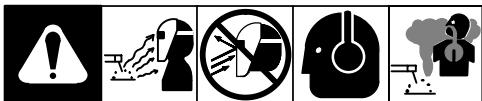

☞ There are four headgear adjustments: headgear top, tightness, angle, and distance.

#### 1 Headgear Top

Adjusts headgear for proper depth on the head to ensure correct balance and stability.

#### 2 Headgear Tightness

To adjust, turn the adjusting knob located on the back of the headgear left or right to desired tightness.

#### 3 Angle Adjustment (Not Shown)

Seven slots on the right side of the headband provide adjustment for the forward tilt of the helmet. To adjust, lift and reposition the control arm to the desired position.

#### 4 Distance Adjustment

Adjusts the distance between the face and the lens. To adjust, press black tabs on the top and bottom of the pivot point and use other hand to slide headgear forward or backward. Release tabs. (Both sides must be equally positioned for proper vision.)

☞ Numbers on the adjustment slides indicate set position so both sides can be adjusted equally.

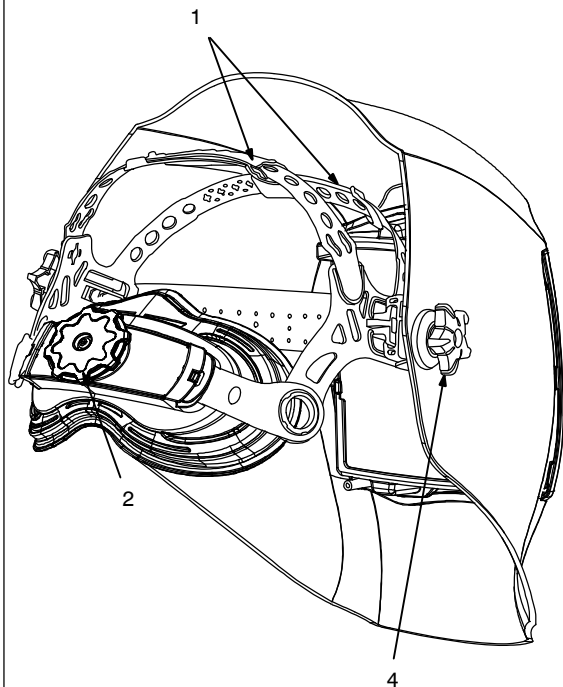

# SECTION 5 – REPLACING THE GRINDING SHIELD OR LENS COVERS

## 5-1. Replacing Lens Covers



**⚠** Never use the auto-darkening lens without the inside and outside lens covers properly installed. Welding spatter will damage the auto-darkening lens and void the warranty.

### Outside Lens Cover

- 1 Lens Holder
- 2 Lens Holder Release Points
- 3 Outside Lens Cover

Remove lens holder by pulling the holder away from the helmet in either bottom corner.

Remove lens cover from shell by pulling top center of lens. Replace lens cover in lens holder by placing one edge in place, bending lens cover, and inserting opposite edge into lens holder channel. Reinstall lens holder in helmet.

### Inside Lens Cover

- 4 Auto-Darkening Lens
- 5 Inside Lens Cover

Remove the inside lens cover by pulling top center of lens cover from lens holding channels.

Replace the lens cover by gently bowing it in the center and inserting it, one end at a time, into the lens holding channels.

**☞** *Be sure the cover lens is seated properly to prevent fogging.*

### Auto-Darkening Lens

- 6 Lens Release Tabs

Remove lens holder and outside lens cover using instructions above. Press down on both lens release tabs and push auto-darkening lens assembly from the inside to remove.

Replace the lens by aligning it on the release tabs and pressing it in until it snaps into place.

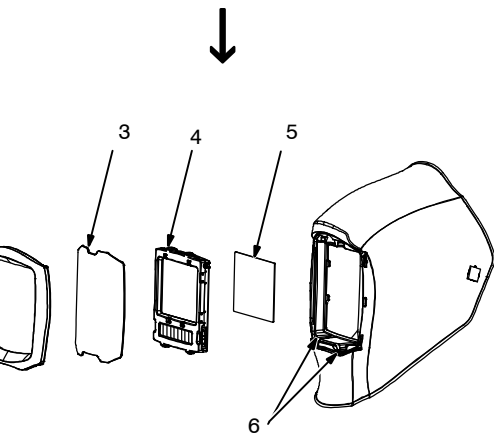
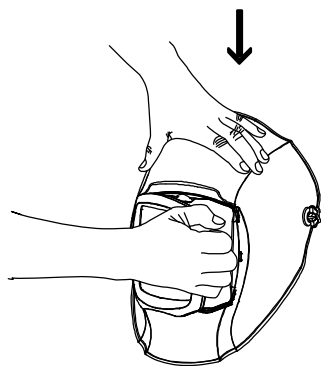
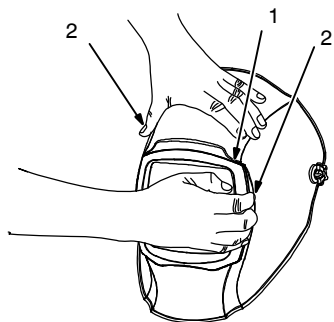

# SECTION 6 – REPLACING THE BATTERY (AUTO-DARKENING LENS ASSEMBLIES)

## 6-1. Replacing The Batteries

**1** Battery Tray

After removing the lens assembly, slide the battery

holding trays out and remove the old batteries.

Replace with CR2450 lithium type batteries (2 required) or equivalent (Miller Part No. 217 043).

Be sure Positive (+) side

*of the battery faces up (toward inside of helmet).*

Reinstall the battery trays. To test battery, press the Auto On/Off button. The display screen should turn On. Reinstall the lens assembly.

# SECTION 7 – INSTALLING OPTIONAL MAGNIFYING LENS

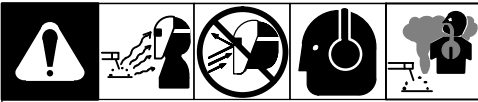

- 1 Optional Magnifying Lens
- 2 Magnifying Lens Adapter Frame

To install optional magnifying lens, a magnifying lens adapter frame is necessary.

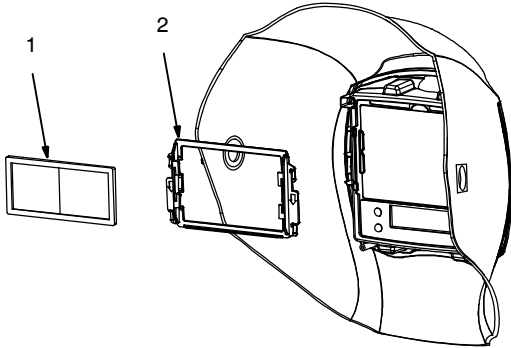

- Install adapter by placing it toward the top of the lens and then sliding the adapter down until it snaps into place.
- Raised arrows and LOCK/UNLOCK text show proper direction.
- Once the adapter is installed, insert the magnifying lens in the top and slide down to desired position.
- Reverse procedure to remove magnifying lens. Lift adapter frame out one edge at a time.

 To prevent lens fogging, install flat side of magnifying lens toward auto-darkening lens.

804 818

# SECTION 8 – MAINTENANCE

**NOTICE** – Never use solvents or abrasive cleaning detergents.

**NOTICE** – Do not immerse the lens assembly in water.

The helmet requires little maintenance. However, for best performance clean after each use. Using a soft cloth dampened with a mild soap and water solution, wipe the cover lenses clean. Allow to air dry. Occasionally, the filter lens and sensors should be cleaned by gently wiping with a soft, dry cloth.



## SECTION 9 – TROUBLESHOOTING



Trouble	Remedy
Auto lens not On – auto-lens will not darken.	Check batteries and verify they are in good condition and installed properly.
	Check battery surfaces and contacts and clean if necessary.
	Check battery for proper contact and gently adjust contact points if necessary. This is particularly important if the helmet has been dropped.
Not switching – auto-lens stays light and will not darken when welding.	Stop welding immediately; Press the Auto On/Off button.
	If power is On, review the sensitivity recommendations and adjust sensitivity.
	Clean lens cover and sensors of any obstructions. Make sure the sensors are facing the arc; angles of 45° or more may not allow the arc light to reach the sensors.
Not Switching – auto-lens stays dark after the weld arc is extinguished, or the auto-lens stays dark when no arc is present.	Fine-tune the sensitivity setting in small increments. In extreme light conditions, it may be necessary to reduce the surrounding light levels.
Sections of the auto-lens are not going dark, distinct lines separate the light and dark areas.	Stop welding immediately; The auto-lens may be cracked which can be caused by the impact of dropping the helmet.
	Weld spatter on the auto lens may also cause cracking. (The lens may need to be replaced; most cracked lenses are not covered by warranty).
Switching or Flickering – the auto-lens darkens then lightens while the welding arc is present.	Review the sensitivity setting recommendations and increase the sensitivity if possible. Be sure the arc sensors are not being blocked from direct access to the arc light.
	Check the lens cover for dirt and spatter that may be blocking the arc sensors. Increasing Lens Delay 0.1 – 0.3 second may also reduce switching.
Inconsistent or lighter auto-lens shading in the dark-state, noticeable on the outside edges and corners.	Referred to as an angle of view effect, auto-darkening lenses have an optimum viewing angle.
	The optimum viewing angle is perpendicular or 90° to the surface of the auto-lens. When that angle of view varies in the dark-state, welders may notice slightly lighter areas at the outside edges and the corners of the lens. This is normal and does not represent any health or safety hazard.
	This effect may also be more noticeable in applications where magnifying lenses are used.

# SECTION 10 – PARTS LIST

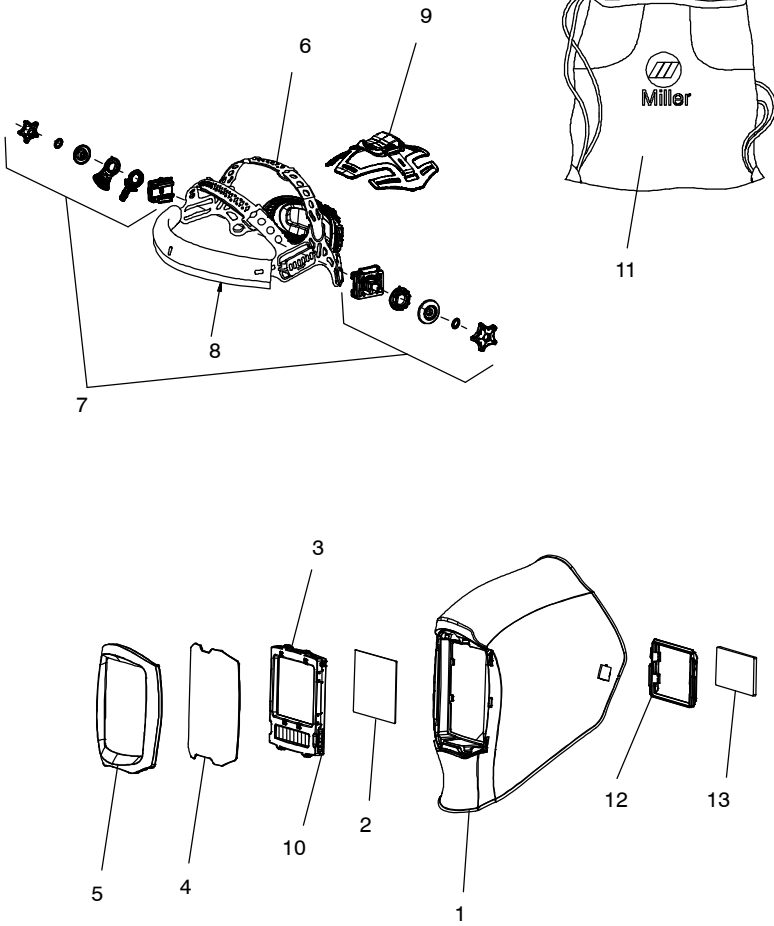

**Figure 10-1. Infinity Auto-Darkening Welding Helmet**

Item No.	Part No.	Description	Quantity
----------	----------	-------------	----------

### Figure 10-1. Infinity Auto-Darkening Welding Helmet

1	271335	Shell, Helmet Black (Infinity)	1
1	271336	Shell, Helmet Stars & Stripes (Infinity)	1
1	271337	Shell, Helmet Camo (Infinity)	1
1	271339	Shell, Helmet Departed (Infinity)	1
2	271319	Lens Cover, Inside 4-3/4 in X 3-1/4 in (Inf)	1
3	271321	Lens Assembly, Auto-Darkening (Infinity)	1
4	271320	Lens Cover, Front 6 in X 5-5/8 in (Inf)	1
5	271322	Holder, Front Lens (Black) (Infinity)	1
5	271323	Holder, Front Lens (Silver) (Infinity)	1
5	271324	Holder, Front Lens (Camo) (Infinity)	1
6	271325	Headgear, Gray (Gen III) (Includes)	1
7	*256178	Kit, Adjustment Angle/Stop Hardware	1
8	770249	Headband, Fabric	1
9	◆271326	Cushion, Top Headgear	1
10	271327	Tray, Battery (Left/Right) (Infinity)	1
	217043	Battery, Lithium (CR2450)	2
11	770250	Bag, Helmet (Miller Logo)	1
12	271328	Adapter, Magnification Lens (XL)	1
13	◆212235	Lens, 0.75 Magnification	1
13	◆212236	Lens, 1.00 Magnification	1
13	◆212237	Lens, 1.25 Magnification	1
13	◆212238	Lens, 1.50 Magnification	1
13	◆212239	Lens, 1.75 Magnification	1
13	◆212240	Lens, 2.00 Magnification	1
13	◆212241	Lens, 2.25 Magnification	1
13	◆212242	Lens, 2.50 Magnification	1
	◆222003	Adapter, Hard Hat	1
	◆259637	Adapter, Hard Hat, Slotted QR	1

\* Adjustment Hardware Kit With O-rings.

◆ Optional

## SECTION 11 – LIMITED WARRANTY

**LIMITED WARRANTY** – Subject to the terms and conditions below. Miller Electric Mfg. Co., Appleton, Wisconsin, warrants to its original retail purchaser that the new Miller equipment sold after the effective date of this limited warranty is free of defects in material and workmanship at the time it is shipped by Miller. THIS WARRANTY IS EXPRESSLY IN LIEU OF ALL OTHER WARRANTIES, EXPRESS OR IMPLIED, INCLUDING THE WARRANTIES OR MERCHANTABILITY AND FITNESS.

Miller Digital Series auto-darkening lens helmets are warranted for 3 years from the date of purchase. *Proof of purchase is required for warranty transactions so it is imperative that a copy of the original invoice or sales receipt be retained.*

**For warranty transactions, contact your Miller Distributor.**

Effective January 1, 2015



Visit our website at  
**[www.MillerWelds.com](http://www.MillerWelds.com)**



**Miller Electric Mfg. Co.**  
An Illinois Tool Works Company  
1635 West Spencer Street  
Appleton, WI 54914 USA