



OM-234 388C

2009-01

Auto-Darkening Helmets Model: Digital Elite™



To help us serve you better, go to www.MillerWelds.Com/HelmetReg/





TABLE OF CONTENTS

SECTION 1 – SAFETY PRECAUTIONS – READ BEFORE USING	1
1-1. Symbol Usage	1
1-2. Hazards	1
SECTION 2 – SPECIFICATIONS	2
SECTION 3 – OPERATING INSTRUCTIONS	3
3-1. Helmet Controls	3
3-2. On-Off Button And Low Battery Indicator	4
3-3. Mode Control	5
3-4. Variable Shade Control	6
3-5. Sensitivity Control	7
3-6. Lens Delay Control	8
3-7. Lens Adjustment Procedure	9
SECTION 4 – ADJUSTING HEADGEAR	10
SECTION 5 – REPLACING THE LENS COVERS	11
5-1. Replacing The Lens Covers On Standard Helmets	11
5-2. Replacing Lens Covers On Classic Black Quick Release Helmets	12
SECTION 6 – REPLACING THE BATTERY	13
SECTION 7 – INSTALLING OPTIONAL MAGNIFYING LENS	14
SECTION 8 – MAINTENANCE	14
SECTION 9 – TROUBLESHOOTING	15
SECTION 10 – PARTS LIST	16
SECTION 11 – LIMITED WARRANTY	20



SECTION 1 – SAFETY PRECAUTIONS – READ BEFORE USING

 **Protect yourself and others from injury — read and follow these precautions.**

1-1. Symbol Usage

	<p>DANGER! – Indicates a hazardous situation which, if not avoided, will result in death or serious injury. The possible hazards are shown in the adjoining symbols or explained in the text.</p>	<p> Indicates special instructions.</p>
	<p>Indicates a hazardous situation which, if not avoided, could result in death or serious injury. The possible hazards are shown in the adjoining symbols or explained in the text.</p>	
<p>NOTICE – Indicates statements not related to personal injury.</p>		
<p>This group of symbols means Warning! Watch Out! ELECTRIC SHOCK, MOVING PARTS, and HOT PARTS hazards. Consult symbols and related instructions below for necessary actions to avoid the hazards.</p>		

1-2. Hazards

	<p>ARC RAYS can burn eyes and skin.</p> <p>Arc rays from the welding process produce intense visible and invisible (ultraviolet and infrared) rays that can burn eyes and skin. Sparks fly off from the weld.</p> <ul style="list-style-type: none"> ● Wear a welding helmet fitted with a proper shade of filter to protect your face and eyes when welding or watching (see ANSI Z49.1 and Z87.1 listed in Safety Standards). Refer to Shade and Sensitivity charts in Sections 3-4 and 3-5. ● Wear approved safety glasses with side shields under your helmet. ● Use protective screens or barriers to protect others from flash and glare; warn others not to watch the arc. ● Wear protective clothing made from durable, flame-resistant material (leather and wool) and foot protection.
	<p>WELDING HELMETS do not provide unlimited eye, ear and face protection.</p> <ul style="list-style-type: none"> ● Use impact resistant safety spectacles or goggles and ear protection at all times when using this welding helmet. ● Do not use this helmet while working with or around explosives or corrosive liquids. ● Do not weld in the overhead position while using this helmet. ● Inspect the auto-lens frequently. Immediately replace any scratched, cracked, or pitted cover lenses or auto-lenses.
	<p>NOISE can damage hearing.</p> <p>Noise from some processes or equipment can damage hearing.</p> <ul style="list-style-type: none"> ● Wear approved ear protection if noise level is high.

SECTION 2 – SPECIFICATIONS

Viewing Field	97 x 60mm/3.81 x 2.62 in
Reaction Time	0.0000500sec (1/20,000)
Operating Modes	4 Modes: Weld, Cutting, Grind, X Mode
Available Shades <i>All shades provide continuous UV and IR protection.</i>	Weld Mode: Darkened State: No. 8 – No. 13 Light State: No. 3 Cutting Mode: Darkened State: No. 5 – No. 8 Light State: No. 3 Grind Mode: Light State: No. 3 X Mode: Darkened State: No. 8 – No. 13 Light State: No. 3
Sensitivity Settings	Adjusts for varying ambient light and welding/cutting arc Weld Mode: No. 0 – No. 10 Cutting Mode: No. 0 – No. 10 Grind Mode: Not Applicable X Mode: No. 0 – No. 10
Delay Settings	Slows lens dark-to-light state Weld Mode: No. 0 – No. 10 Cutting Mode: No. 0 – No. 10 Grind Mode: Not Applicable X Mode: No. 0 – No. 10
Automatic Power Off	Shuts lens Off 15–20 minutes after last arc is struck
Low Battery Indicator	Display indicates 2–3 days remaining battery life
Power Supply	CR2450 Lithium Batteries (Miller Part No. 217 043)
Sensors	Independent/Redundant (Four)
Operating Temperature	14°F to 131°F / -10°C to +55°C ☞ <i>When stored in extremely cold temperatures, warm helmet to ambient temperature before welding.</i>
Storage Temperature	-4°F to 158°F / -20°C to +70°C ☞ <i>When stored in extremely cold temperatures, warm helmet to ambient temperature before welding.</i>
Total Weight	510.3 g (1 lb 2oz.)
Standards	ANSI Z87.1 and CSA/TUV
Warranty	2 years from date of purchase (see Section 11)

☞ *The helmets in this manual are covered by one or more of the following patents:*
 U.S. Patent – No. 6,552,316, No. 6,483,090, No. 6,614,409
 U.S. Patent Application – No. 29/223,100, No. 11/053,977, No. 10/565,858, No. 11/589,542
 DE. Patent – No. 199 59 944 C2, No. 199 59 945 C2
 FR. Patent – No. 9916004

SECTION 3 – OPERATING INSTRUCTIONS

3-1. Helmet Controls

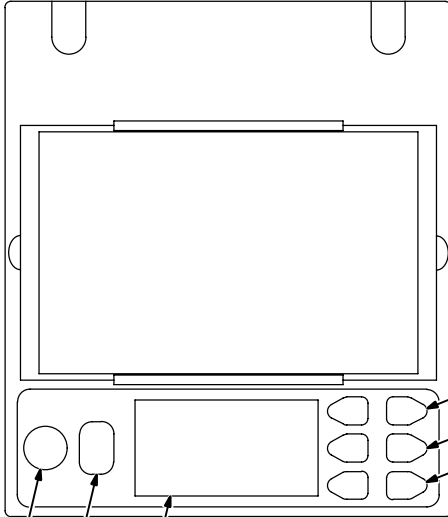

1 2 3

- 1 On-Off Button (See Section 3-2)
- 2 Mode Control Button (See Section 3-3)
- 3 Display Screen
- 4 Variable Shade Control Buttons (See Section 3-4)
- 5 Sensitivity Control Buttons (See Section 3-5)
- 6 Lens Delay Control Buttons (See Section 3-6)

 *The lens assembly saves the shade, sensitivity, and delay settings when the lens turns off.*

3-2. On-Off Button And Low Battery Indicator

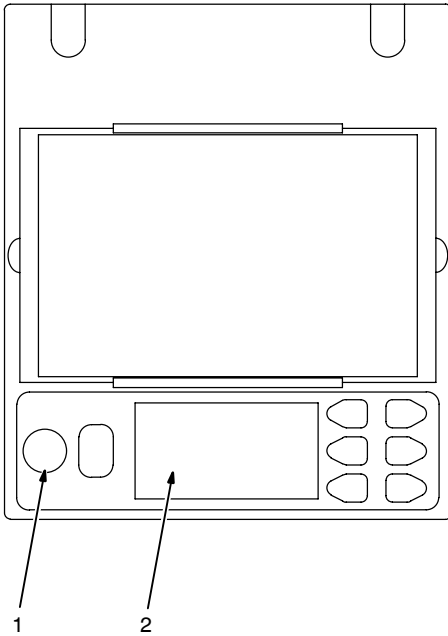
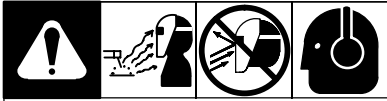

1 On-Off Button

Press On-Off button to check if the lens is working properly and to begin lens shade, sensitivity, and delay adjustments.

When the On-Off button is pressed, the lens should darken and return to the clear state. Do not use the helmet if the lens does not function as described. (See Section 9, Troubleshooting.)

2 Low Battery Indicator

The message "Low Battery" appears on the display screen when 2-3 days of battery life remains.

If battery power is low, replace with CR2450 lithium batteries (2 required - Miller Part No. 217 043) See Section 6.

3-3. Mode Control

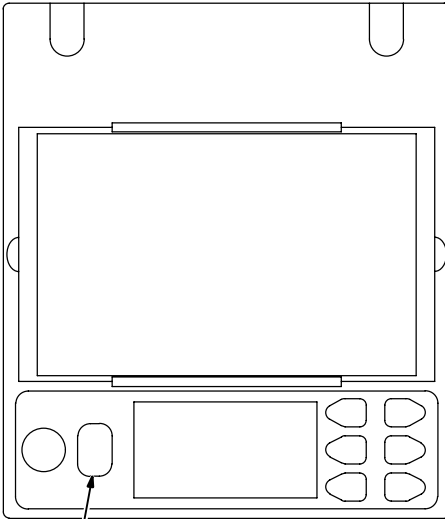
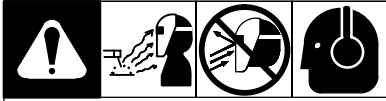

1

1 Mode Control Button

Press button to select the mode appropriate for the work activity:

Weld Mode – used for most welding applications. In this mode the lens turns on when it optically senses a welding arc. Adjust shade, sensitivity, and delay settings as needed.

Cutting Mode – used for cutting applications. In this mode the lens turns on when it optically senses a cutting arc. Adjust shade, sensitivity, and delay settings as needed.

Grind Mode – used for metal grinding applications. In this mode the shade is fixed shade No. 3. No lens adjustments are possible.

X Mode – used for outdoor or low current welding applications. In this mode the lens turns on when it senses weld current. Adjust shade, sensitivity, and delay settings as needed.

 *Nearby welding may affect helmet operation when lens is in X Mode. Stay at least 12 ft (3.7 m) away from other welding activity.*

3-4. Variable Shade Control

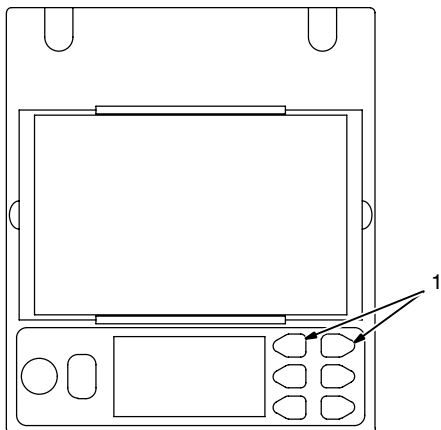

1 Shade Control Buttons

Use the shade control Down and Up buttons to select the lens shade in the darkened state. The shade ranges for each mode are as follows:

Weld – No. 8 – No. 13

Cutting – No. 5 – No. 8

Grind – No. 3 only

X Mode – No. 8 – No. 13

Start at the highest setting and adjust lighter to suit the application and your personal preference.

Use the table below to select proper shade control setting based on your welding process.

805 010

Application Welding	Arc Current in Amperes	Protective Shade No.
Stick Electrodes	Less than 40	9
	40–80	10
	80–175	11
	175–300	12
	300–500	13
MIG	Less than 100	10
	100–175	11
	175–300	12
	300–500	13
Gas Tungsten Arc Welding (TIG)	Less than 50	10
	50–100	11
	100–200	12
	200–400	13
Air Carbon	Less than 500	12
	500–700	13
Plasma Arc Cutting	60–150	11
	150–250	12
	250–400	13
Plasma Arc Welding	Less than 50	9
	50–200	10
	200–400	12

3-5. Sensitivity Control

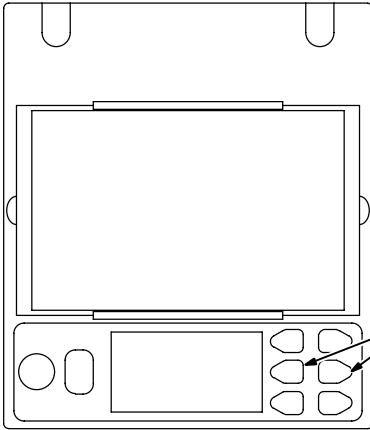
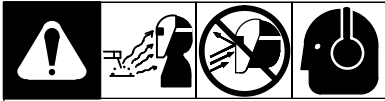

1 Sensitivity Control Buttons

Use Sensitivity Control Low and Hi buttons to make the lens more responsive to different light levels in various welding processes. **Use a sensitivity setting of 5 for most applications.**

The sensitivity ranges for each mode are as follows:

Weld, Cutting, X Modes – 0 – 10

Grind Mode – No sensitivity adjustment

It may be necessary to adjust helmet sensitivity to accommodate different lighting conditions or if lens is flashing On and Off. Adjust helmet sensitivity as follows:

 *Adjust helmet sensitivity in lighting conditions helmet will be used in.*

- Press Sensitivity Low button to lower setting to 0.
- Face the helmet in the direction of use, exposing it to the surrounding light conditions.
- Press Sensitivity Hi button repeatedly until the lens darkens, then press Low button until lens clears. Helmet is ready for use. Slight readjustment may be necessary for certain applications or if lens is flashing on and off.

805 010

Recommended Sensitivity Settings

Stick Electrode	Mid-Range
Short Circuiting (MIG)	Low/Mid-Range
Pulsed & Spray (MIG)	Mid-Range
Gas Tungsten Arc (TIG)	Mid/High-Range
Plasma Arc Cutting/Welding	Low/Mid-Range
Grinding	No sensitivity setting; use Grind mode

3-6. Lens Delay Control

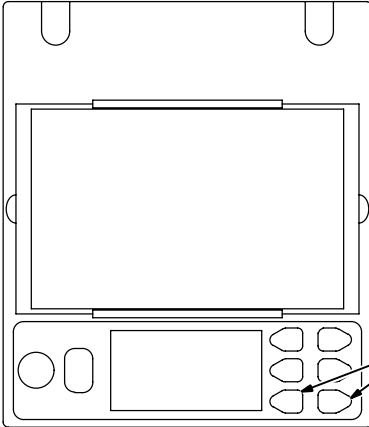
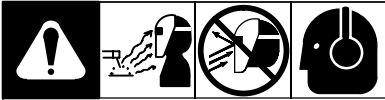

1 Lens Delay Control

Use the Lens Delay Control Fast and Slow buttons to adjust the time for the lens to switch to the clear state after welding or cutting.

The delay is particularly useful in eliminating bright after-rays present in higher amperage applications where the molten puddle remains bright momentarily after welding. Use the Lens Delay Control buttons to adjust delay from 0 to 10 (0.1 to 1.0 second).

 *There is no lens delay adjustment in the Grind mode.*

3-7. Lens Adjustment Procedure

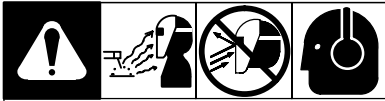

☞ Lens assembly displays prior settings when turned On. Retained settings are not shown in example.

☞ In the Grind mode the lens is a fixed shade No. 3. No lens adjustments are possible.

Adjusting Lens Assembly:

- Turn lens On. Display screen appears.
- Select mode (Weld, Cutting, Grind, X-Mode)
- Select Shade By Pressing Down/Up Buttons.
- Select Sensitivity By Pressing Low/Hi Buttons.
- Select Delay by Pressing Fast/Slow Buttons.
- Begin work.

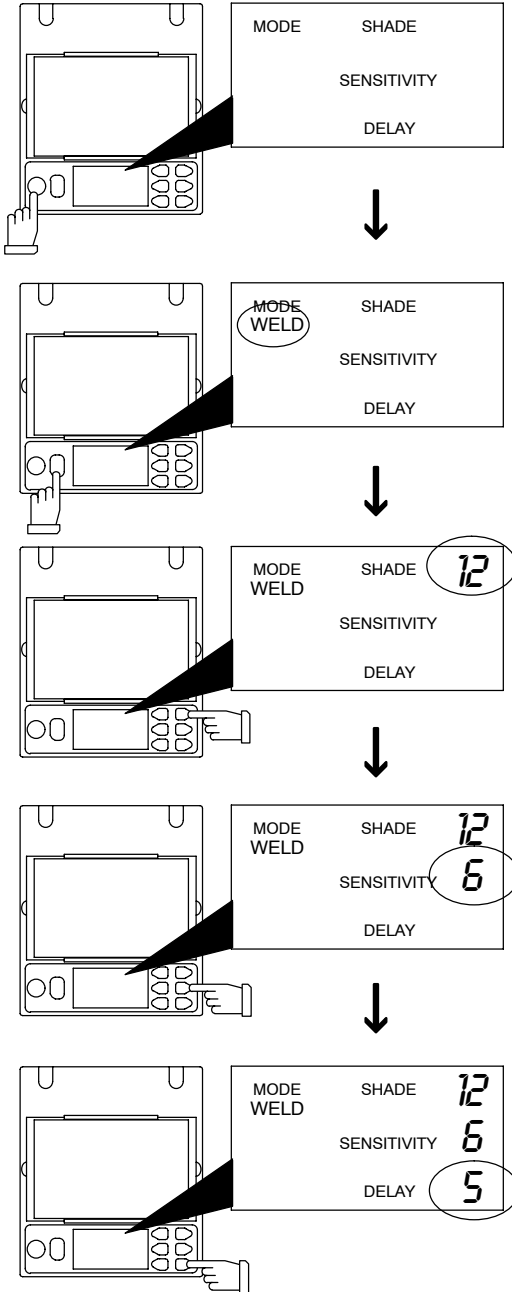

SECTION 4 – ADJUSTING HEADGEAR

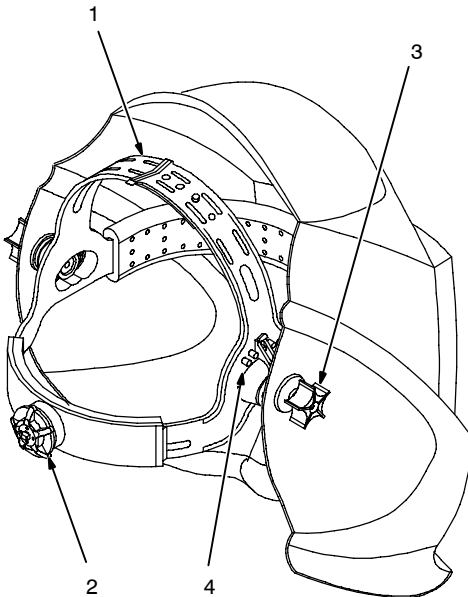
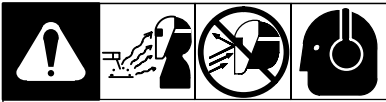

☞ *There are four headgear adjustments: headgear top, tightness, angle adjustment, and distance adjustment.*

1 Headgear Top

Adjusts headgear for proper depth on the head to ensure correct balance and stability.

2 Headgear Tightness

To adjust, push in the adjusting knob located on the back of the headgear and turn left or right to desired tightness.

☞ *If adjustment is limited, it may be necessary to remove the comfort cushion.*

3 Distance Adjustment

Adjusts the distance between the face and the lens. To adjust, loosen both outside tension knobs and press inward to free from adjustment slots. Move forward or back to desired position and retighten. (Both sides must be equally positioned for proper vision.)

4 Angle Adjustment

Four pins on the right side of the headband top provide adjustment for the forward tilt of the helmet. To adjust, loosen the right outside tension adjustment knob then lift on the control arm tab and move it to the desired position. Retighten tension adjustment knob.

☞ *When using the back distance adjustment positions, only the back three angle adjustment pins can be used.*

SECTION 5 – REPLACING THE LENS COVERS

5-1. Replacing The Lens Covers On Standard Helmets

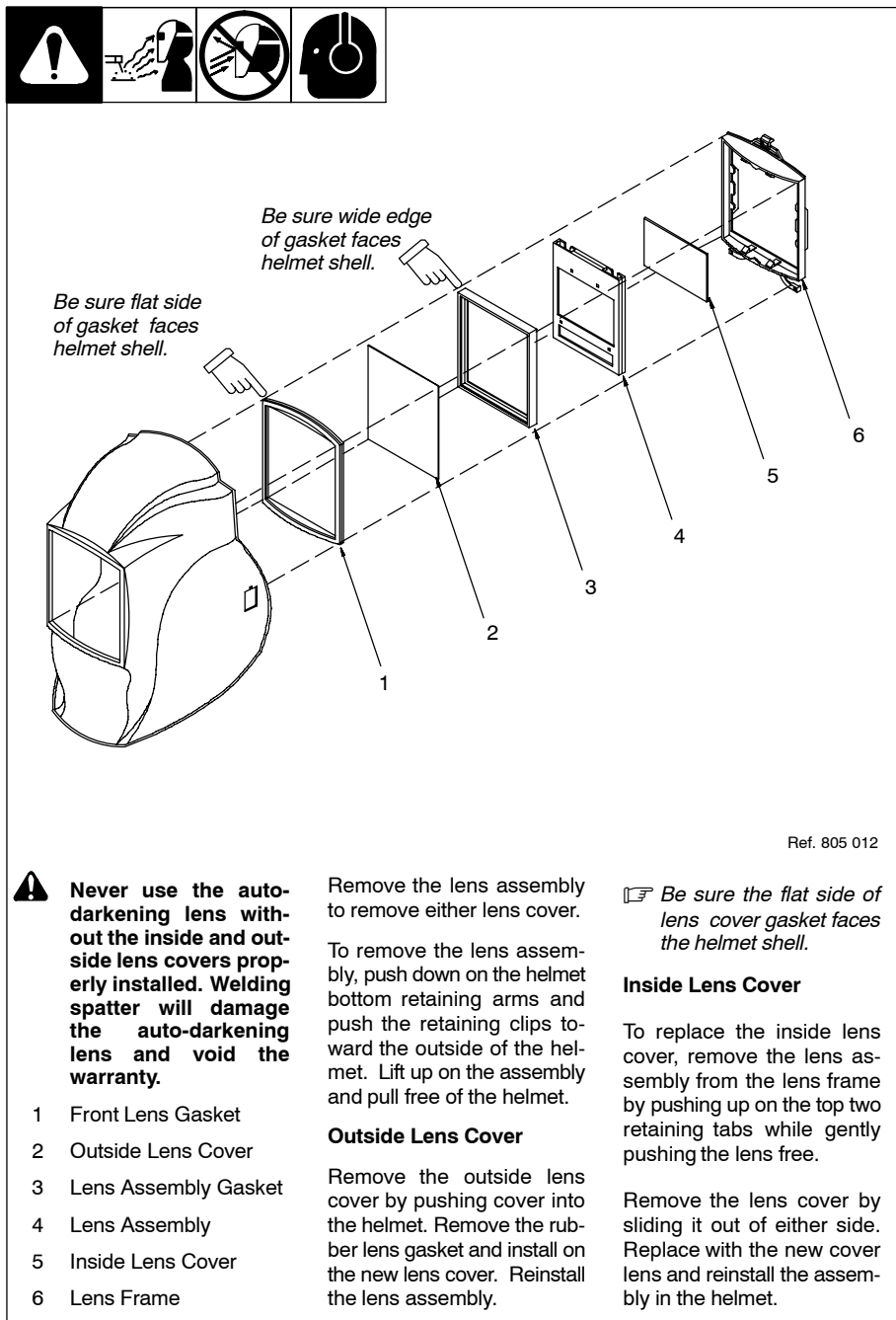

5-2. Replacing Lens Covers On Quick Release Helmets

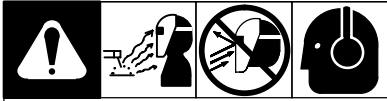

⚠ Never use the auto-darkening lens without the inside and outside lens covers properly installed. Welding spatter will damage the auto-darkening lens and void the warranty.

- 1 Front Lens Holder
- 2 Release Points
- 3 Lens Cover

Remove front lens holder by pressing release points and pulling the holder away from the helmet.

Remove lens cover from the holder. Replace lens cover in holder. Reinstall holder in helmet.

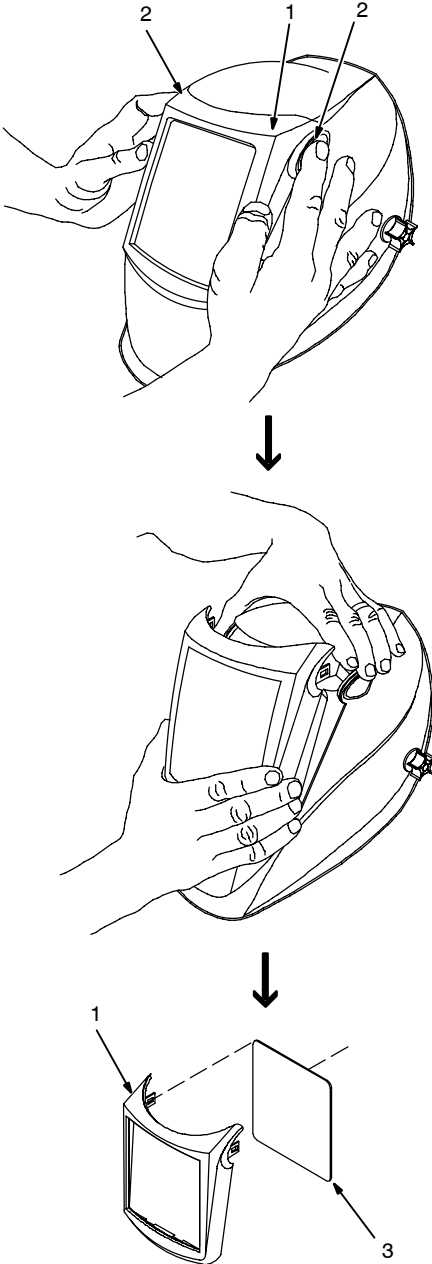

804 814 / 804 816

SECTION 6 – REPLACING THE BATTERY

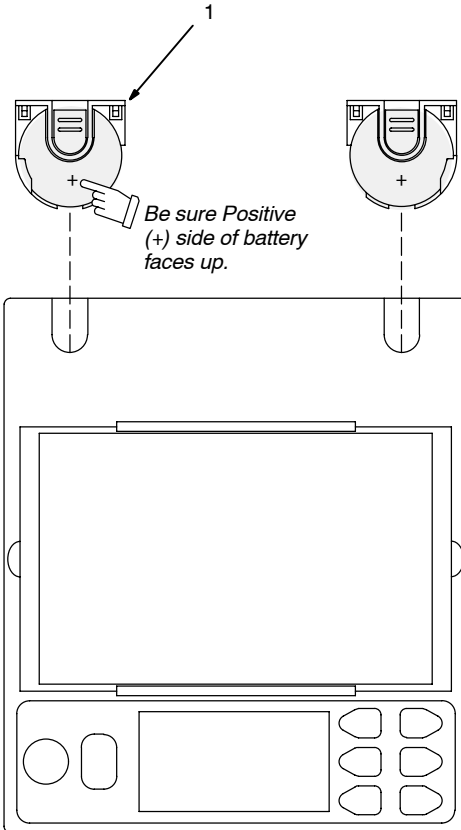
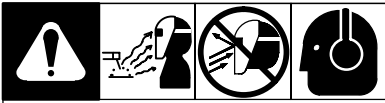

To replace the batteries, remove the auto-darkening lens assembly (see Section 5).

1 Battery Tray

After removing the lens assembly, slide the battery holding trays out and remove the old batteries.

Replace with CR2450 lithium type batteries (2 required) or equivalent (Miller Part No. 217043).

ⓘ Be sure Positive (+) side of the battery faces up (toward inside of helmet).

Reinstall the battery trays. To test, press the On button. The display screen should turn on. Reinstall the lens assembly.

ⓘ Left and right battery trays are not interchangeable. The auto-darkening helmet will not work if battery trays are installed on the wrong sides.

SECTION 7 – INSTALLING OPTIONAL MAGNIFYING LENS

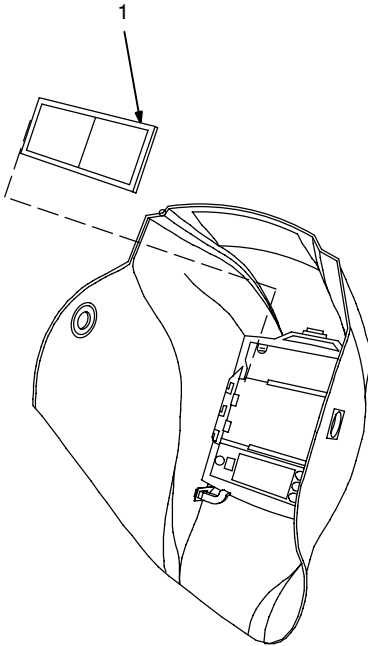

1 Optional Magnifying Lens

Starting at the top, slide magnifying lens into the helmet retaining brackets. Align the magnifying lens with the auto-darkening lens assembly.

Reverse procedure to remove magnifying lens.

 *To prevent lens fogging, install flat side of magnifying lens toward auto-darkening lens.*

805 011

SECTION 8 – MAINTENANCE

NOTICE – Never use solvents or abrasive cleaning detergents.

NOTICE – Do not immerse the lens assembly in water.

The helmet requires little maintenance. However, for best performance clean after each use. Using a soft cloth dampened with a mild soap and water solution, wipe the cover lenses clean. Allow to air dry. Occasionally, the filter lens and sensors should be cleaned by gently wiping with a soft, dry cloth.

SECTION 9 – TROUBLESHOOTING



Trouble	Remedy
Auto lens not ON – auto-lens does not darken momentarily when the On button is pressed.	<p>Check batteries and verify they are in good condition and installed properly.</p> <p>Check battery surfaces and contacts, and clean if necessary.</p> <p>Check battery for proper contact and gently adjust contact points if necessary. This is particularly important if the helmet has been dropped. Verify left and right battery trays are installed on the correct sides.</p>
Not switching – auto-lens stays light and does not darken when welding or cutting.	<p>Stop welding or cutting immediately: Make sure the lens is turned On.</p> <p>If power is On, check the mode settings. Also review sensitivity recommendations and adjust sensitivity if possible.</p> <p>Clean lens cover and sensors of any obstructions. Make sure the sensors are facing the arc; angles of 45° or more may not allow the arc light to reach the sensors.</p>
Not Switching – auto-lens stays dark after the arc is extinguished, or the auto-lens stays dark when no arc is present.	<p>Reduce Sensitivity setting (see Section 3-5). In extreme light conditions, it may be necessary to reduce the surrounding light levels.</p> <p> <i>If the lens remains dark, press the On-Off button to return lens to the clear state.</i></p>
Sections of the auto-lens are not going dark, distinct lines separate the light and dark areas.	<p>Stop welding or cutting immediately: The auto-lens may be cracked which can be caused by the impact of dropping the helmet.</p> <p>Weld spatter on the auto lens may also cause cracking. (The lens may need to be replaced; most cracked lenses are not covered by warranty).</p>
Switching or Flickering – the auto-lens darkens then lightens while the welding or cutting arc is present.	<p>Review the sensitivity setting recommendations and increase the sensitivity if possible. Be sure the arc sensors are not being blocked from direct access to the arc light.</p> <p>Check the lens cover for dirt and spatter that may be blocking the arc sensors. Increasing Lens Delay 0.1 – 0.3 second may also reduce switching.</p>
Inconsistent or lighter auto-lens shading in the dark-state, noticeable on the outside edges and corners.	<p>Referred to as an angle of view effect, auto-darkening lenses have an optimum viewing angle.</p> <p>The optimum viewing angle is perpendicular or 90° to the surface of the auto-lens. When that angle of view varies in the dark-state, welders may notice slightly lighter areas at the outside edges and the corners of the lens. This is normal and does not represent any health or safety hazard.</p> <p>This effect may also be more noticeable in applications where magnifying lenses are used.</p>

SECTION 10 – PARTS LIST

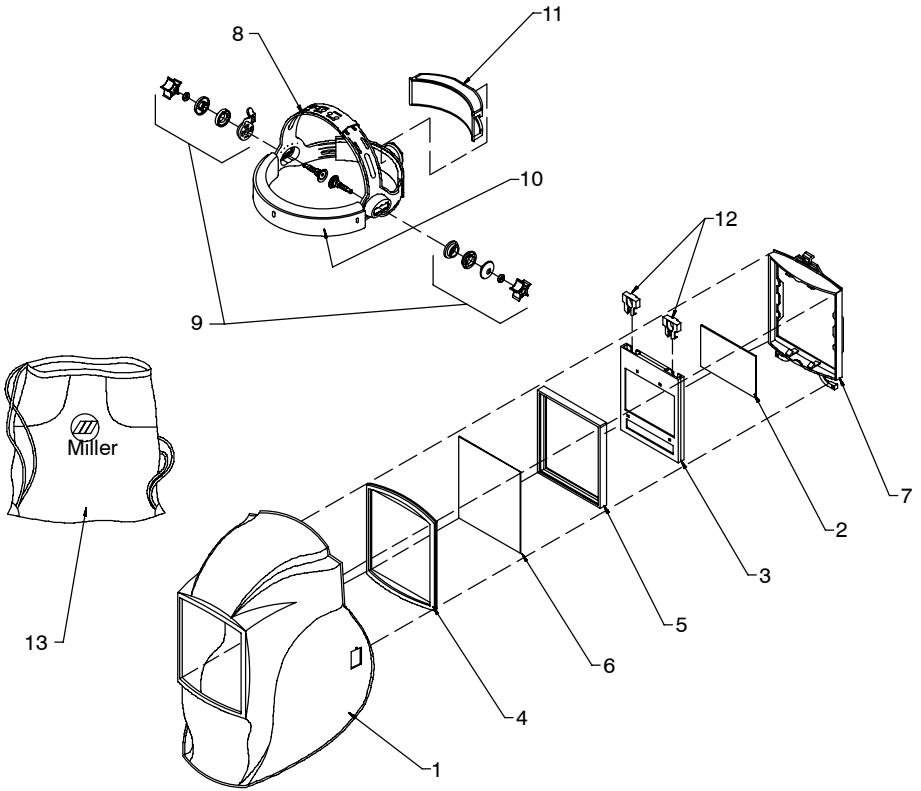

Figure 10-1. Digital Elite Auto-Darkening Welding Helmet – Standard Models

804 111

Item No.	Part No.	Description	Quantity
----------	----------	-------------	----------

Figure 10-1. Digital Elite Auto-Darkening Welding Helmet – Standard Models

1	216 331	Helmet Shell, Black	1
1	227 189	Helmet Shell, The Joker	1
1	234 066	Helmet Shell, Stars And Stripes II	1
1	223 454	Helmet Shell, Inferno	1
2	216 327	Inside Lens Cover (4-1/4 X 2-1/2) (5 Per Pkg.)	1
3	234 760	Auto-darkening Lens Assembly	1
4	216 337	Gasket, Front Lens – Cover	1
5	234 758	Gasket, Auto-Darkening Lens Assembly	1
6	216 326	Outside Lens Cover (4-11/16 X 5-5/8) (5 Per Pkg.)	1
7	234 759	Frame, Lens	1
8	770 246	Ratchet Headgear Assembly (Includes Items 9 And 10)	1
9	770 248*	Adjustment Angle/Stop Hardware Kit	1
10	770 249	Fabric Headband	1
	079 975	Replacement O-rings For Kit 770 248 (5 Per Pkg.)	1
11	216 336	Comfort Cushion, Foam Rubber	1
12	216 339	Battery Tray Kit (Left/Right)	1
	217 043	Battery, Lithium (CR2450)	2
	222 003	Hard Hat Adapters (Not Shown)	1
13	770 250	Helmet Bag – Miller	1
	212 235	Lens, 0.75 Magnification (Not Shown)	1
	212 236	Lens, 1.00 Magnification (Not Shown)	1
	212 237	Lens, 1.25 Magnification (Not Shown)	1
	212 238	Lens, 1.50 Magnification (Not Shown)	1
	212 239	Lens, 1.75 Magnification (Not Shown)	1
	212 240	Lens, 2.00 Magnification (Not Shown)	1
	212 241	Lens, 2.25 Magnification (Not Shown)	1
	212 242	Lens, 2.50 Magnification (Not Shown)	1

* Adjustment Hardware Kit With O-rings.

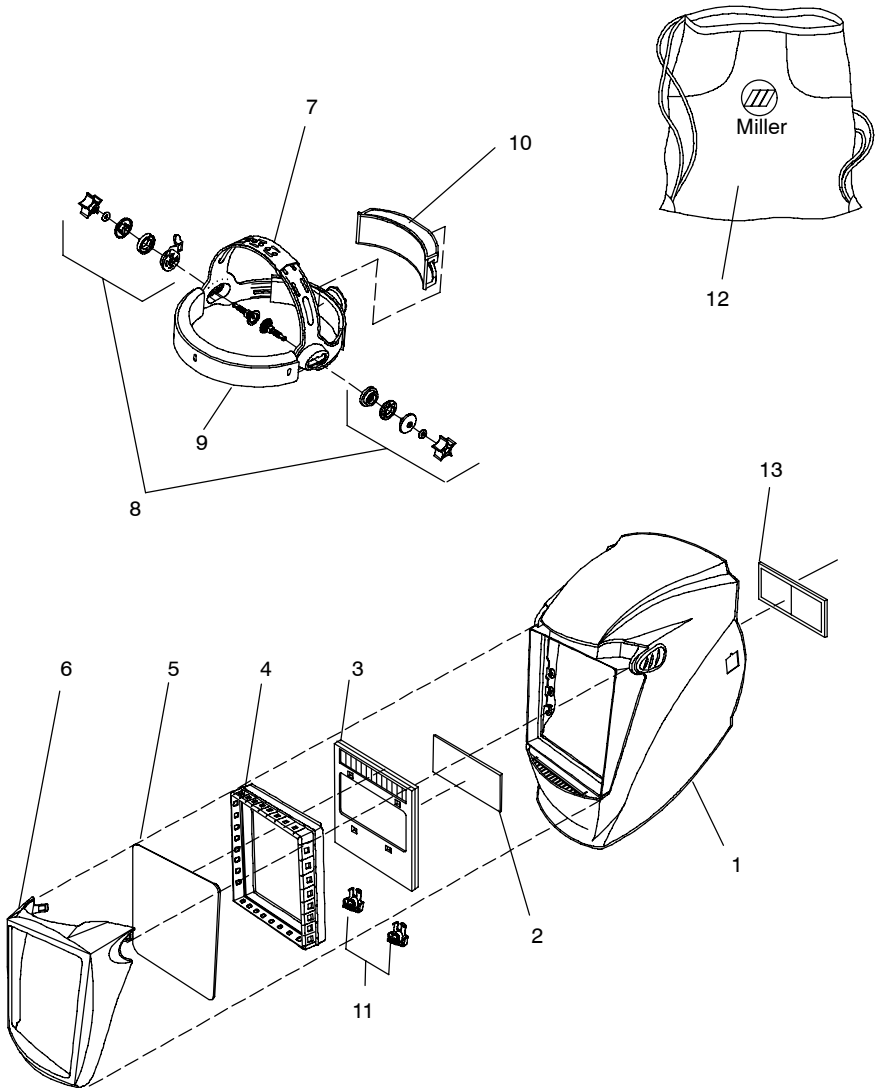

242 385 / Ref. 804 111

Figure 10-2. Digital Elite Series Auto-Darkening Welding Helmet – Quick Release Models

Item No.	Part No.	Description	Quantity
Figure 10-2. Digital Elite Auto-Darkening Welding Helmet – Quick Release Models			
1	241 976	Helmet Shell, Black (Includes Item 6)	1
2	216 327	Inside Lens Cover (4-1/4 X 2-1/2) (5 Per Pkg.)	1
3	234 760	Auto-darkening Lens Assembly	1
4	241 977	Gasket, Lens Assembly	1
5	216 326	Outside Lens Cover (4-11/16 X 5-5/8) (5 Per Pkg.)	1
6	241 978	Front Lens Holder (Black)	1
7	770 246	Ratchet Headgear Assembly (Includes Items 9 And 10)	1
8	770 248*	Adjustment Angle/Stop Hardware Kit	1
9	770 249	Fabric Headband	1
	079 975	Replacement O-rings For Kit 770 248 (5 Per Pkg.)	1
10	216 336	Comfort Cushion, Foam Rubber	1
11	216 339	Battery Tray Kit (Left/Right)	1
	217 043	Battery, Lithium (CR2450)	2
	222 003	Hard Hat Adapters (Not Shown)	1
12	770 250	Helmet Bag – Miller	1
13	212 235	Lens, 0.75 Magnification (Not Shown)	1
	212 236	Lens, 1.00 Magnification (Not Shown)	1
	212 237	Lens, 1.25 Magnification (Not Shown)	1
	212 238	Lens, 1.50 Magnification (Not Shown)	1
	212 239	Lens, 1.75 Magnification (Not Shown)	1
	212 240	Lens, 2.00 Magnification (Not Shown)	1
	212 241	Lens, 2.25 Magnification (Not Shown)	1
	212 242	Lens, 2.50 Magnification (Not Shown)	1

* Adjustment Hardware Kit With O-rings.

SECTION 11 – LIMITED WARRANTY

Effective January 1, 2009

LIMITED WARRANTY – Subject to the terms and conditions below. Miller Electric Mfg. Co., Appleton, Wisconsin, warrants to its original retail purchaser that the new Miller equipment sold after the effective date of this limited warranty is free of defects in material and workmanship at the time it is shipped by Miller. THIS WARRANTY IS EXPRESSLY IN LIEU OF ALL OTHER WARRANTIES, EXPRESS OR IMPLIED, INCLUDING THE WARRANTIES OR MERCHANTABILITY AND FITNESS.

Miller Elite Series auto-darkening lens helmets are warranted for 2 years from the date of purchase. *Proof of purchase is required for warranty transactions so it is imperative that a copy of the original invoice or sales receipt be retained.*

For warranty transactions, contact your Miller Distributor.



Visit our website at
www.MillerWelds.com



Miller Electric Mfg. Co.
An Illinois Tool Works Company
1635 West Spencer Street
Appleton, WI 54914 USA